

# Refrigeration, air-conditioning and cooling technology

Planning Guide



2007

## CONTENTS

<b>Fundamentals of refrigeration, air-conditioning and cooling technology</b>	<b>5</b>
Pump curves	6
Suction behaviour of the centrifugal pump	9
Pump efficiency	11
Power requirements of the pump	12
Pressure behaviour	14
Pumping of viscous media	15
<b>Noises – Airborne sound – Structure-borne sound</b>	<b>19</b>
Pumps as noise generators	19
Airborne sound	20
Structure-borne sound and waterborne sound	20
Measures against noises	21
<b>Pump inlet</b>	<b>29</b>
Pump sump	29
Suction lines and suction tanks	30
Suctioning	31
<b>Pump performance control</b>	<b>33</b>
Control mode $\Delta p$ -c	33
Control mode $\Delta p$ -v	34
Differential pressure – delivery-superimposed ( $\Delta p$ -q)	34
Control mode $\Delta p$ -T	35
Operating mode DDC	35
<b>Generator circuits in the liquefier part</b>	<b>37</b>
Cooling tower / emergency cooler	37
Heat recovery	38
Geothermal power in the condenser circuit	39
<b>Generator circuits in the vaporiser part</b>	<b>41</b>
Constant volume flow in the vaporiser circuit	41
Variable volume flow in the vaporiser circuit	42
Cold-water loads	43
<b>Protection of pumps and refrigerating machines</b>	<b>47</b>
Minimum run-time of refrigeration generators and buffer mode	47
Protection of the refrigerating machine in the vaporiser circuit	49
Protection of the refrigerating machine in the condenser circuit	49
Protection of circulating pumps	50

<b>Examples for the pump selection in the condenser circuit</b>	<b>57</b>
Well system	57
Open cooling tower system	59
Closed cooling tower system	61
Heat recovery via building heating and hot water production	63
Ground collector system	65
Ground spike system	67
<b>Examples for the pump selection in the cold water circuit</b>	<b>68</b>
Flow rate control with straight-through valves	68
Flow rate control with distributor valve	70
Admixing circuit for temperature control	72
<b>Examples for the pump selection in the vaporiser circuit</b>	<b>74</b>
Vaporiser circuit with constant volume flow	74
Hydraulic decoupler in vaporiser circuit	75
Vaporiser circuit with ice storage	76
Vaporiser circuit with variable volume flow	78
<b>Economical consideration in the selection of fittings</b>	<b>83</b>
<b>Appendix</b>	<b>86</b>
<b>Seminars</b>	<b>98</b>
<b>Information material</b>	<b>99</b>
<b>Imprint</b>	<b>103</b>



# Fundamentals of refrigeration, air-conditioning and cooling technology

The transportation of refrigeration, air-conditioning and cooling fluid plays an important role inside of buildings. Cold water is pumped for cooling work machines in industry and to the vaporiser in building engineering. Air-conditioners require fluids for heat transport and utilise the active force of circulating pumps for faster exchange and short regulation times. In cooling towers, fluids are pumped with and without fluid processing for accomplishing tasks.

Fluid heat transfer media require pumps and systems for transport, which meet the various chemical, physical, mechanical and financial requirements.

The contents of this brochure should give people who are being trained or getting additional training basic knowledge of system design. Different designs and versions of systems with liquid heat transfer media can bring about direct ramifications due to irritating noise generation or component failure. The user should be given an adequate practical basis with simple explanations, drawings and examples. The selection and appropriate use of pumps with their accessories in refrigeration, air-conditioning and cooling technology should become daily routine.

It is to be considered that various standards (EN, DIN, VDE, ISO, IEC) and directives (VDI, DVGW, ATV, VDMA) are to be complied with and special aggregates and techniques selected. National building regulations and environmental protection directives, etc. pose additional demands. The basic requirements are taken into consideration in this brochure. Since requirements are constantly changing, additional information channels with the newest state of the art must flow into system planning every day. This cannot be achieved with the contents of this brochure.

Please observe the further option for increasing your knowledge based on this planning guide for refrigeration, air-conditioning and cooling systems by using our documentation and information materials. We have compiled an up-to-date overview. Here you will find documents which you can read on your own and our seminar program with practical training.

FUNDAMENTALS

Pump curves

System curve

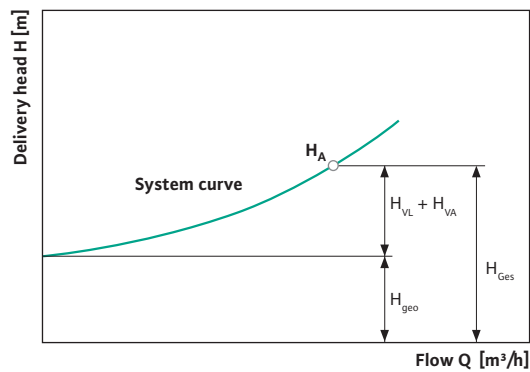

Abbreviation Description

$H_A$	Required delivery head of the system
$H_{VL}$	Pressure losses in the pipelines
$H_{VA}$	Pressure losses in the fittings
$H_{geo}$	Static head difference (static head difference to be overcome)
$H_{Ges}$	Total head losses

System curve

The static components consist of the geodetic part which is independent of flow  $H_{geo}$  and the pressure head difference

$$\frac{p_a - p_e}{\rho \cdot g}$$

between the entry and exit cross-section of the system.

This last component is omitted in the case of open tanks. The dynamic components consist of the pump head loss  $H_V$ , which increases quadratically with increasing flow, and the difference in the velocity heads

$$\frac{v_a^2 - v_e^2}{2 \cdot g}$$

out of the entry and exit cross-section of the system.

System curve

The system curve indicates the delivery head  $H_A$  required by the system. It consists of the components  $H_{geo}$ ,  $H_{VL}$  and  $H_{VA}$ . While  $H_{geo}$  (static) remains constant independent of the volume flow,  $H_{VL}$  and  $H_{VA}$  (dynamic) increase quadratically due to the widely varying losses in the pipelines and fittings, as well as due to increased friction, etc. due to temperature influences.

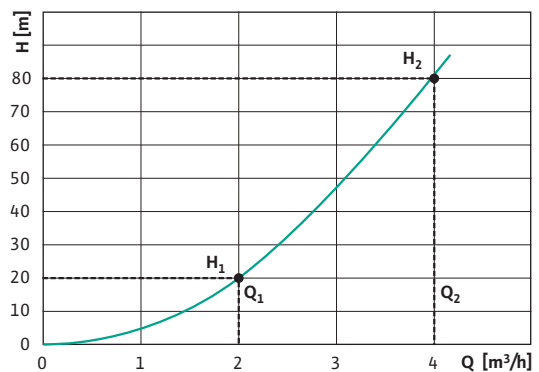

Resistance changes quadratically with flow

$$\frac{H_1}{H_2} = \left( \frac{Q_1}{Q_2} \right)^2$$

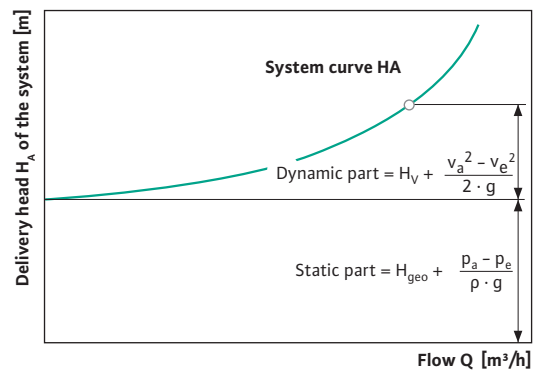

Abbreviation Description

$v_a$	Exit speed
$v_e$	Entry speed
$p_a$	Exit pressure
$p_e$	Entry pressure
$\rho$	Fluid density
$g$	Gravitational acceleration
$H_V$	Pressure loss in the pipework

### Pump curve

The flow rate of a centrifugal pump is specified by a pump curve in the Q vs. H diagram. In this, the flow Q is plotted, for example, in m<sup>3</sup>/h and the pump delivery head H in m.

The pump curve is curvilinear and drops in the diagram with increasing flow from left to right. The gradient of the pump curve is determined by the pump design and also specifically by the construction form of the impeller. Every change in the delivery head always results in a change in flow.

The characteristic property of the pump curve is the mutual dependence of the flow on the delivery head.

**High flow  $\hat{=}$  low delivery head,  
low flow  $\hat{=}$  high delivery head.**

Although the installed pipeline system exclusively specifies which flow is pumped at the given pump capacity due to the internal resistances, the pump in question can always take on only one duty point on its curve. This duty point is the intersection of the pump curve with the respective system curve.

### Duty point

The duty point is the intersection of the system curve and the pump curve. The duty point adjusts itself independently in pumps with a fixed speed.

A change in the duty point occurs when, for example, in the case of a stationary pump station, the geodetic delivery head fluctuates between the maximum and minimum values. Due to this, the delivered volume flow of the pump changes since this can only take on duty points on the pump curve.

A reason for a fluctuating duty point could be a varying water level in the sump/tank, since here the inlet pressure of the pump is changed by the different level. On the discharge side, this change can be due to incrustation of the pipeline or due to the throttling of the valves or the load.

Practically speaking, the system curve only changes by increasing or decreasing the resistances (e.g. closing or opening the throttling element, change in the pipeline diameter when modifications are carried out, incrustation, etc.) when there are solid-free fluids of normal viscosity in the system.

### Pump curve

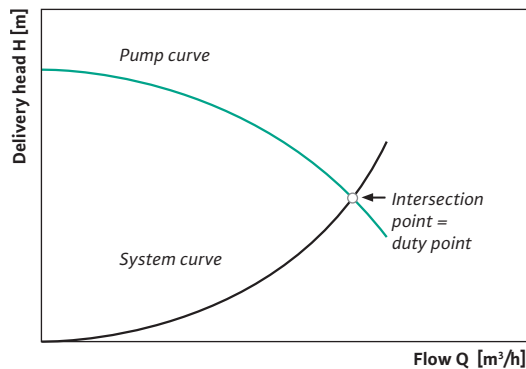

*The pump delivery head is always as high as the flow resistance of the pipeline system.*

### Fluctuating water level in the tank

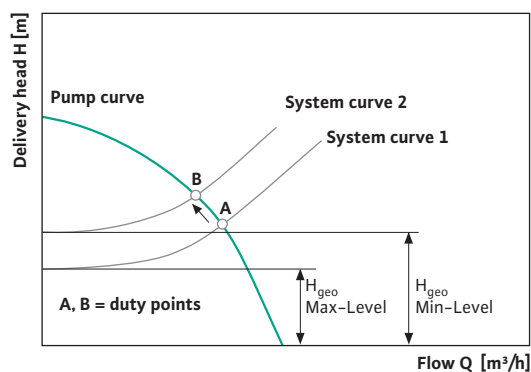

### Speed and duty point

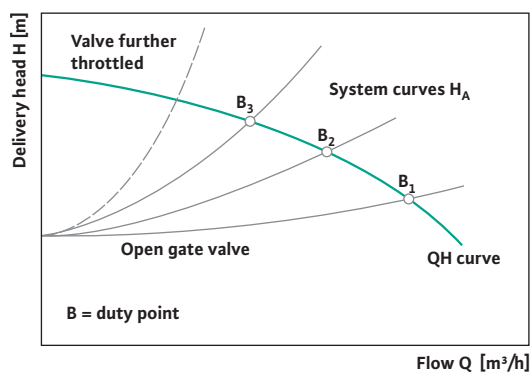

FUNDAMENTALS

A change in the duty point can generally only be achieved by changing the speed  $n$  or the impeller diameter  $D$  of a pump in the case of radial impellers.

Change in flow

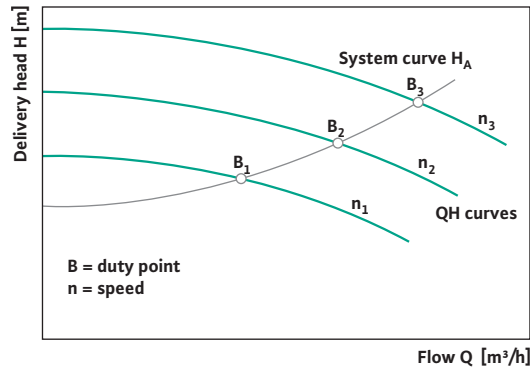

Change in speed

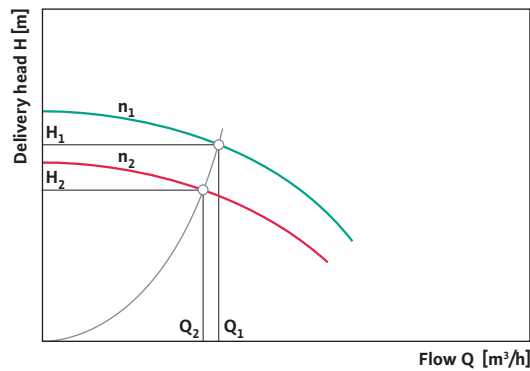

$$\frac{Q_1}{Q_2} = \frac{n_1}{n_2}$$

$$\frac{H_1}{H_2} = \left(\frac{n_1}{n_2}\right)^2$$

$$\frac{P_1}{P_2} = \left(\frac{n_1}{n_2}\right)^2$$

Change in the impeller diameter

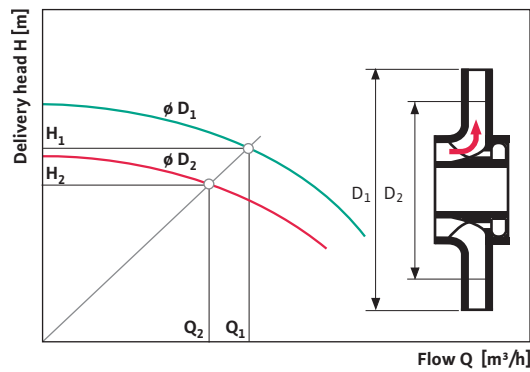

$$\frac{Q_1}{Q_2} \approx \frac{D_1}{D_2} \quad D_2 \approx D_1 \sqrt{\frac{Q_2}{Q_1}}$$

$$\frac{H_1}{H_2} \approx \left(\frac{D_1}{D_2}\right)^2 \quad D_2 \approx D_1 \sqrt{\frac{H_2}{H_1}}$$

Valve authority

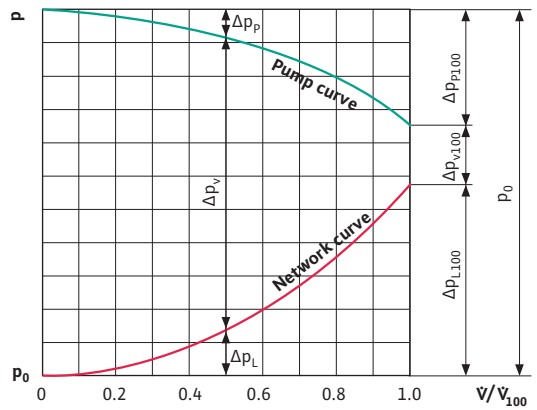

Pump curve with valve authority

For the working characteristics, it is important how high the pressure drop at the valve is when the valve is completely open with respect to the total pressure to the lines to be regulated. This ratio is called the "valve authority  $P_V$ ":

$$P_V = \frac{\Delta p_{V100}}{\Delta p_{ges}} = \frac{\Delta p_{V100}}{\Delta p_V + \Delta p_r} = \frac{\Delta p_{V100}}{\Delta p_{V0}}$$

Abbreviation Description

$p_0$	Maximum pump pressure
$\Delta p_P$	Pressure loss in the pump
$\Delta p_V$	Pressure drop at the valve
$\Delta p_r$	Pressure drop in the rest of the system
$p_b$	Reference pressure of the system
$\Delta p_L$	Pressure loss in the system
$V$	Flow
$V_{100}$	Flow with valve completely open
$P_V$	Valve authority

The last expression is especially practical from an instrumentation point of view because the valve authority can be calculated from the pressure drop at the open ( $\Delta p_{V100}$ ) and at the closed valve ( $\Delta p_{V0}$ ).



## Suction behaviour of the centrifugal pump

### General

The cause of pump suction is the pressure applied to the liquid level in the suction tank, so in the case of an open tank, this is the atmospheric air pressure. Its mean value at sea level is  $p_b = 101320 \text{ N/m}^2 (= 1.0132 \text{ bar})$  and is equivalent to the pressure of a water column 10.33 m high at 4 °C. Thus, normal air pressure must allow the pump to be able to pump water from a depth of about 10 m. The actually reachable geodetic suction head  $H_{S_{\text{geo}}}$  is considerably less, however. The reasons for this are:

- Fluids evaporate when the temperature-dependent vapour pressure  $p_D \text{ N/m}^2$  is reached. The pressure can then only drop to this value at the highest point of the suctioned fluid column.
- Pump head losses occur in the suction line as a result of speed generation  $-v_S^2/2g \text{ [m]}$  –, as well as due to fluid friction, direction changes and changes in cross-section  $H_{VS} \text{ [m]}$ .

A further pump head loss is caused by friction and speed changes when the fluid enters the blade channels. To avoid vapour formation, the total head (static pump head plus the velocity head  $v_S^2/2g$ ) in the entry cross-section of the pump must therefore be greater than the vapour pressure head of the pumped fluid by a certain amount. This energy difference is referred to as NPSH [m], the abbreviation for "net positive suction head", and is identical with the previously common term "maintained pressure head  $H_H$ ".

When the pump is installed above the suction water level, and the shaft is horizontal and the suction tank open, the head difference  $H_{S_{\text{geo}}}$  may not be greater than

$$H_{S_{\text{geo}}} = \frac{p_b}{g \cdot \rho} - \frac{P_D}{g \cdot \rho} - H_{VS} - \text{NPSH [m]}$$

with gravitational acceleration  $g$  in  $\text{m/s}^2$  and the density  $\rho$  in  $\text{kg/m}^3$ . If the suction tank is closed, then the absolute pump head in the tank  $(p_1 + p_b)/g \cdot \rho$  appears for  $p_b/g \cdot \rho$ , whereby  $p_1$  stands for the overpressure in the tank. With the pressure units in bar, the density  $\rho$  in  $\text{kg/dm}^3$  and  $g = 9.81 \text{ m/s}^2$ , the equation takes on the following generally valid form:

$$H_{S_{\text{geo}}} = \frac{10.2 \cdot (p_b + p_1 - P_D)}{\rho} - H_{VS} - \text{NPSH [m]}$$

In the case of underpressure in the suction tank,  $p_1$  has a negative sign.

### Required NPSH (NPSHR)

The smallest value of the NPSH at which the pump can be continuously operated under the given working conditions (speed, flow, delivery head, pumped fluid) can be determined from the pump curves in the catalogues. The NPSH defined this way is also called NPSHR (NPSH required). It is not a constant value, but strongly increases with increasing flow. If one compares centrifugal pumps having different specific speeds, one can see that the NPSH value grows with increasing specific speed. The suction then decreases. Pumps which run very fast can therefore often only overcome low suction heads or even only be operated at inlet head, even with cold water. Improvement is possible by selecting a lower operating speed, but this at the cost of economic efficiency.

### Available NPSH (NPSHA)

For an existing or planned system, the NPSHA available at the entry cross-section of the pump can be determined by solving the equation for NPSH:

$$\text{NPSHA} = \frac{10.2 \cdot (p_b + p_1 - P_D)}{\rho} - H_{VS} - H_{S_{\text{geo}}} \text{ [m]}$$

If the fluid level is above the pump, instead of  $H_{S_{\text{geo}}}$  the geodetic inlet head  $H_{z_{\text{geo}}}$  is plugged in and the equation becomes:

$$\text{NPSHA} = \frac{10.2 \cdot (p_b + p_1 - P_D)}{\rho} - H_{VS} + H_{S_{\text{geo}}} \text{ [m]}$$

- When planning a pump system, it is recommended that a pump be selected which has an NPSHR at least 0.5 m lower than the available NPSHA.
- For a pump in operation, by measuring the pressure  $p_1$  at the suction flange of the pump, the NPSHA can be calculated from the equation

$$\text{NPSHA} = \frac{10.2 \cdot (p_b + p_1 - P_D)}{\rho} + \frac{v_1^2}{2 \cdot g} - H_{S_{\text{geo}}} \text{ [m]}$$

with the previously given units for the pressure and density. If this is an underpressure,  $p_1$  is given a negative sign. The quantity  $v_1$  is the average flowrate in the entry cross-section  $A_1$  of the pump,  $v_1 = Q/A_1$  with  $Q$  in  $\text{m}^3/\text{s}$  and  $A_1$  in  $\text{m}^2$ .

## FUNDAMENTALS

### Influence of air pressure

The magnitude of the atmospheric air pressure has a considerable effect on the suction. Apart from weather-related fluctuations of  $\pm 5\%$  of the customary mean value, the air pressure decreases with increasing altitude:

Altitude above sea level	0	500	1000	2000	3000	m
Average air pressure $p_b$	1.013	0.955	0.899	0.794	0.700	bar

### Influence of fluid temperature

When hot water is pumped, the vapour pressure head plays a major role. If a fluid is boiling,  $p_l + p_b = p_D$  and  $H_{s\ geo}$  becomes negative. An inlet head  $H_{z\ geo}$  is therefore required. Furthermore, the equation can be simplified to

$$NPSHA = H_{z\ geo} - H_{vS} [m]$$

Also for temperatures which lie under the boiling point, suction is reduced so that even then an inlet head might be necessary.

#### Influence of the fluid temperature on the inlet head

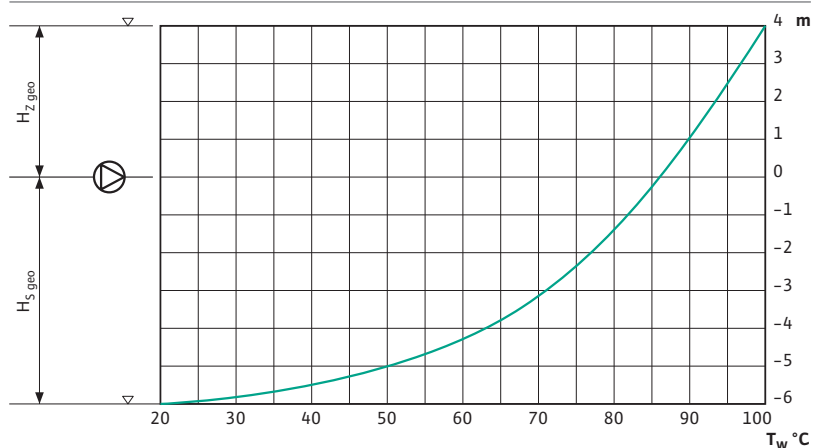

It is assumed that a pump can overcome a geodetic suction head of  $H_{s\ geo} = 6\text{ m}$  at a water temperature of  $20^\circ\text{C}$ . With increasing water temperature, and therefore also increasing vapour pressure,  $H_{s\ geo}$  decreases and at a water temperature of  $t_w \approx 87^\circ\text{C}$  turns into an inlet head, which has the constant minimum value  $H_{z\ geo} = 4\text{ m}$  once the boiling state has been reached.

## Pump efficiency

The ratio of the delivered power – hydraulic pump capacity (flow x delivery head) – to the absorbed power (drive power) is given by the pump efficiency. The efficiency changes along the pump curve.

In building engineering, the pump efficiency is only given indirect consideration when assessing the pump. For this reason, this is often omitted from documentation. The power consumption of the pump is the crucial factor.

Only in larger aggregates, for example in process engineering or in large plant construction, where there is a differentiated consideration of the pump operation, these efficiency specifications are mandatory.

The pump efficiency is defined:

$$\eta_p = \frac{Q \cdot H \cdot \rho \cdot g}{P}$$

In the case of pumping in the customary temperature range for building engineering, the following modified equation can also be used.

$$\eta_p = \frac{Q \cdot H}{367 \cdot P}$$

Since the efficiency and power consumption have a direct relationship, a duty point with maximum efficiency should be selected with regard to the operating costs.

In general, the range of the best pump efficiency is in the centre third of the pump curve. Pump dimensioning in the first or last third of the pump curve always means operation in the worse pump efficiency range and should be avoided. For pumps where the drive motor is designed for the entire curve, another thing that must be considered is that electromotors have their best efficiencies only under full load, or at the maximum permitted flow. This means, taking both factors into consideration, that the optimum duty point is shifted to the right of centre of the curve.

### Pump curve and efficiency curve

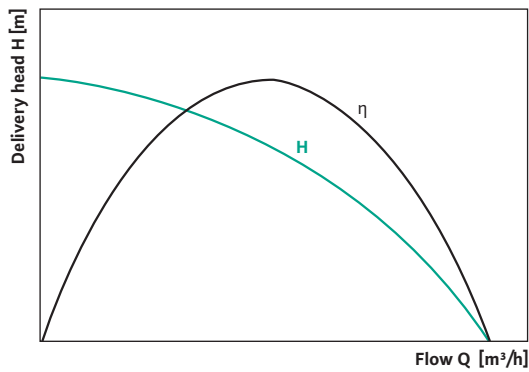

Pump curve and efficiency curve in the Q vs. H diagram

Abbreviation	Description	Unit
$\eta_p$	Pump efficiency	
Q	flow	m <sup>3</sup> /s
H	delivery head	m
$\rho$	mass density of the fluid g [m/s <sup>2</sup> ]	kg/m <sup>3</sup>
P	power of the motor (shaft power)	W
g	local gravitational acceleration	m/s <sup>2</sup>
367	3600 sec divided by 9.8665 = local gravitational acceleration	

With pumps of the glandless series where the pump and motor form one encapsulated unit, instead of the pump efficiency  $\eta_p$  customary for glanded pumps, the total efficiency  $\eta_{pGes}$  is specified. They are coupled via the motor efficiency  $\eta_M$ .

The cause for this differentiated form of representation is the different construction form of both pump types.

## FUNDAMENTALS

In the case of glanded pumps, a multitude of drive motors (standard motors, special motors) are used which have very different efficiencies, making it necessary to determine the individual overall efficiency.

In the case of glandless pumps, special motors are fundamentally used which are exactly tuned to the pump. It is not possible to separate the units motor and pump. Thus, the overall efficiency for every pump is exactly fixed.

The efficiency of motors for glandless pumps can't be directly compared with the efficiencies of motors for glanded pumps. The completely different designs and applications forbid comparison. Encapsulated motors are specially developed for use in building engineering. The water level in the rotor compartment and the metallic separation (can) between the rotor and winding result in an efficiency which is lower by a factor of 2 to 4 than in standard motors.

### Efficiencies with standard glandless pumps (approximate values)

Pumps with motor power $P_2$	$\eta_M$	$\eta_{Pump}^*$	$\eta_{Gesamt}^{**}$
up to 100 W	approx. 15 –	approx. 40 –	approx. 5 –
	approx. 45 %	approx. 65 %	approx. 25 %
100 to 500 W	approx. 45 –	approx. 40 –	approx. 20 –
	approx. 65 %	approx. 70 %	approx. 40 %
500 to 2500 W	approx. 60 –	approx. 30 –	approx. 30 –
	approx. 70 %	approx. 75 %	approx. 50 %

### Efficiencies for glanded pumps (approximate values)

Pumps with motor power $P_2$	$\eta_M$	$\eta_{Pump}^*$	$\eta_{Gesamt}^{**}$
up to 1.5 kW	approx. 75 %	approx. 40 –	approx. 30 –
		approx. 85 %	approx. 65 %
1.5 to 7.5 kW	approx. 85 %	approx. 40 –	approx. 35 –
		approx. 85 %	approx. 75 %
7.5 to 45.0 kW	approx. 90 %	approx. 40 –	approx. 40 –
		approx. 85 %	approx. 80 %

\* Variations depend on design, nominal diameter, etc. The smaller value generally applies for pumps with extremely low volume flow and relatively high delivery head.

\*\* Limit values of  $\eta_{Ges}$  or  $\eta_{Pump}$  don't have to correspond.

Since, however, the encapsulated motor also gives off approx. 85 % of the motor heat to the fluid, the percentage heat loss is very low.

The table above shows a general overview of pump efficiencies. It can be seen that the efficiency improves with increasing pump capacity, since losses within the pump remain nearly constant, thus having a smaller effect compared to the increasing overall pump capacity.

## Power requirements of the pump

To exactly design the pump drive and to calculate the operating costs/efficiency, knowledge of the required power at the respective pump duty point is necessary. The required power or power consumption of the pump is therefore also shown in a diagram like the hydraulic flow rate of the pump.

The dependency of the drive power of the pump on flow is shown. At max. flow, the max. required power of the pump is also reached. The drive motor of the pump is designed for this point when the pump is operated over the entire curve.

Glandless pumps are always furnished with motors which allow operation over the entire curve. This way, the number of types is reduced, making replacement parts easier to keep in stock.

If the calculated duty point for a pump (glanded design) lies in the front range of the curve, for example, the drive motor can be selected smaller according to the associated power requirement. In this case, however, there is the danger of motor overload when the actual duty point lies at a greater flow than calculated (system curve is flatter).

### Hydraulic flow rate of the pump

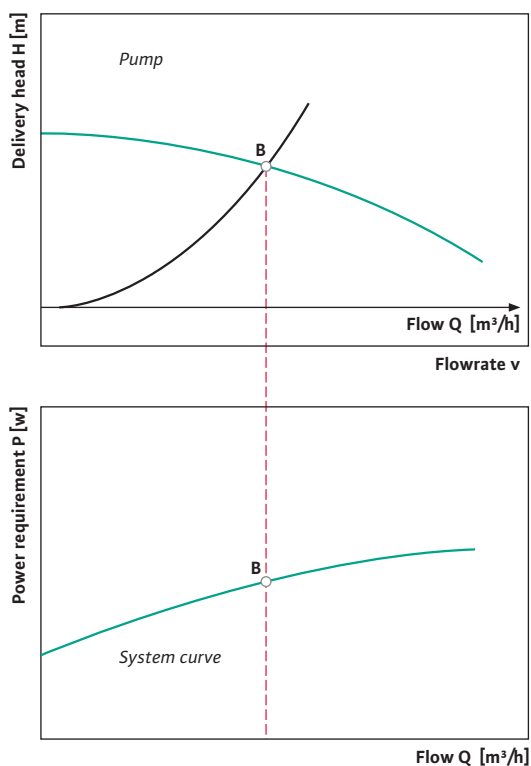

Since in practice a shift in the duty point can always be expected, the power of the drive motor of a glanded pump must be set by approx. 5 to 20% higher than the assumed requirement would be.

To calculate the operating costs of a pump, it must be fundamentally distinguished between the power requirement of the pump  $P_2$ , often equated with the installed motor power, and the power consumption of the drive motor  $P_1$ . The latter is the basis of the operating cost calculation. If only the power requirement  $P_2$  is given, this can also be used, but by simultaneously taking the motor efficiency into account according to the following equation.

$$P_1 = \frac{P_2}{\eta_M}$$

Abbreviation	Description
$P_1$	Power consumption of the drive motor
$P_2$	Power requirement at the pump shaft
$\eta_M$	Motor efficiency

The electric power consumption  $P_1$  is given when the pump and drive motor form an encapsulated unit, like with the so-called glandless pumps. Here, it's even customary to put both values  $P_1$  and  $P_2$  on the name plate.

For aggregates where the pump and motor are coupled via a coupling or rigid shaft connection, like with the glanded pumps, the required shaft power  $P_2$  is given. This is required for these pump designs since the wide variety of motor designs – starting with the IEC standard motor to the special motor – with their various power consumptions and efficiencies are installed on the pump.

The power consumptions of the pumps given in the documentation of the pump manufacturer always refer to the water as the fluid in the area of building engineering with:

Specific density  $\rho = 1000 \text{ kg/m}^3$   
 Kinematic viscosity  $\nu = 1 \text{ mm}^2/\text{s}$

When there is a deviation in the specific density, the power consumption changes proportionally to the same degree.

Lower spec. density  $\hat{=}$  Lower power consumption  $P_1$

Higher spec. density  $\hat{=}$  Higher power consumption  $P_1$

This practically means that pumps which are operated at high water temperatures, and thus lower spec. density of the fluid, usually require lower motor power. For the temperatures and pump capacities which can be found in building engineering, this correction isn't carried out. Thus, on the drive side there is a certain motor reserve.

When there is a deviation in the kinematic viscosity (by admixing to the fluid, only viscosity increase relevant), there is also a change in the power consumption.

Higher viscosity  $\hat{=}$  Higher power consumption

The change is not proportional and must be specially calculated.

FUNDAMENTALS

Pressure behaviour

Pressure diagram

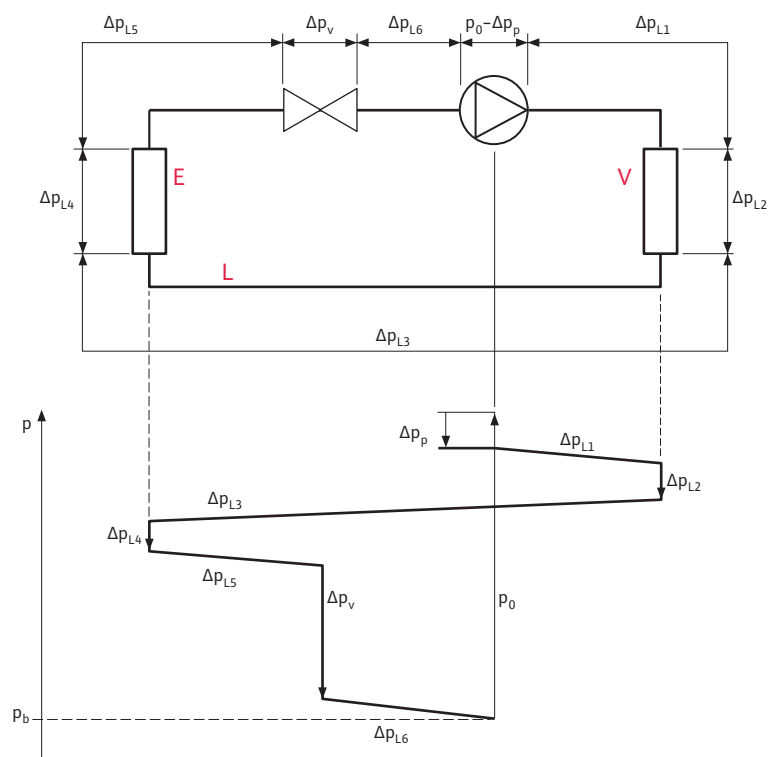

Pressure curve in pipelines and fittings

Pressure losses are reductions in the pressure between the component inlet and outlet. Among these components are pipelines, aggregates and fittings. The losses occur due to turbulence and friction. Every pipeline and fitting has its own specific loss value, depending on the material and surface roughness. The specifications can be obtained from the manufacturer. An overview of the standard losses used by Wilo can be found in the appendix.

Abbreviation	Description
E	Generator
V	Load
$p_0$	Maximum pump pressure
$\Delta p_P$	Pressure loss in the pump
$\Delta p_V$	Pressure drop at the valve
$\Delta p_r$	Pressure drop in the rest of the system
$p_b$	Reference pressure of the system
$\Delta p_L$	Pressure loss in the system

Pressure surge

If a pipeline with flowing fluid is suddenly closed at one spot, the fluid mass inside it can only come to rest with a time delay due to its inertia. Due to this "negative" acceleration of the fluid mass, the forces applied to the pipe wall and shut-off device increase ( $F = m \cdot a$ ). Such types of pressure surges must be observed in the dimensioning of pipeline systems (telescope lines, cooling water circuits, etc.) as the maximum load. Air chambers are installed for damping the pressure surge.

Especially endangered here are installations where lines are not laid continuously falling or rising. Since the water columns can break off at the high points (vacuum formation) or increased pressure is created when water columns meet, pipes could burst.

The pressure increase when there is a sudden closing of a throughflow fitting is simplified as follows:

$$\Delta p = \rho \cdot V \cdot v$$

Abbreviation	Description	Unit
a	Acceleration	$m/s^2$
v	Speed (Speed of sound for water ~ 1 400 m/s)	m/s
$\rho$	Density	$kg/m^3$
m	Mass	kg
F	Force	N
V	Volume flow	$m^3/h$

## Pumping of viscous media

The representation of the pump capacity data in the Q vs. H diagram also usually refers to water as the fluid, as in the calculation of the system curve, with a kinematic viscosity of  $\nu = 1 \text{ mm}^2/\text{s}$ .

The pump data changes for fluids of other viscosities and densities. The data correction which should be done even for hot water pumping to be correct can be neglected in building engineering. **There only has to be a check for serious changes (more than 10% volume percentage) in the water when additives are used, such as glycol, etc.** Hereby, it is to be observed that the planning of pump systems, and thus the determination of the pump data Q, H, P, is divided up into two sections for pumping fluids of higher viscosity.

- It may only be used when there is a completely adequate maintained system pressure value (NPSHA) available.

The values to be specified for determination are:

1. Operating temperature  $t$  [°C] of the fluid at the pump.
2. Density  $\rho$  [kg/m<sup>3</sup>] of the fluid at lowest specified operating temperature.
3. Kinematic viscosity  $\nu$  [cSt or mm<sup>2</sup>/s] of the fluid at the lowest specified operating temperature.
4. Required volume flow of the fluid  $Q_{\text{vis}}$  [m<sup>3</sup>/h].
5. Required delivery head of the fluid  $H_{\text{vis}}$  [m].

### Change in the system curve

A correction in the system curve / characteristics of existing systems calculated for water pumping for operation with fluids of other viscosities and densities must be done taking the changing flow characteristics into account. These correction factors can not be specified by the pump manufacturer.

The new system curve can be determined with the help of the relevant flow-related professional literature / information from the fittings manufacturers.

Sample curve for potential changes in a circulating pump

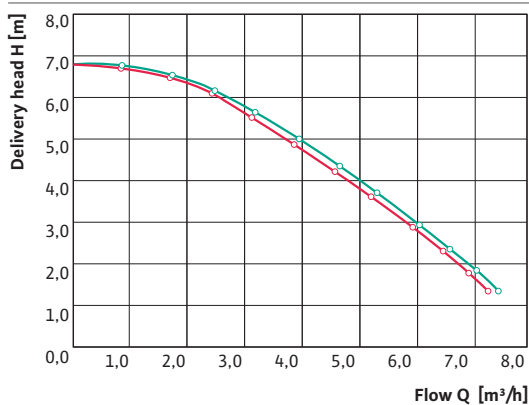

Change in the flow rate due to higher fluid viscosity

### Change in the pump characteristics

Similar to how it is in the system, influences on the frictional moments and inner flow conditions arise in the pump as well due to the changed fluid properties, which, added up, can result in a deviating pump curve. The electric power consumption of the pump unit is influenced. Since individual measurements of all pumps aren't feasible for many possible operating media due to cost reasons, various conversion methods have been developed (Hydraulic Institute, pump manufacturer, etc.). The methods have limited precision and are subject to certain restrictions.

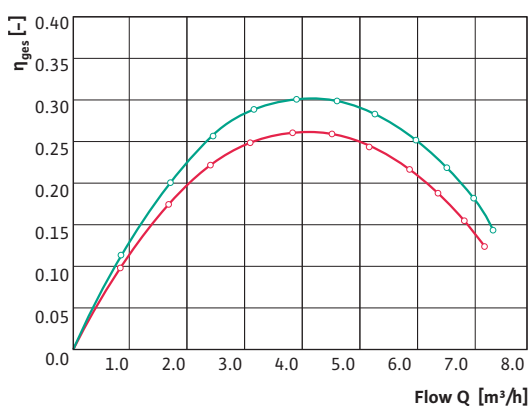

Change in the efficiency due to higher fluid viscosity

### Notes

The described method is sufficiently accurate for determining the flow rate for Wilo screwed-connection and flange-end pumps when the following basic conditions are complied with:

- It may only be used for homogenous Newton fluids. In the case of muddy, gelatine-like fibre-containing and other inhomogeneous fluids, there are strongly scattered results.

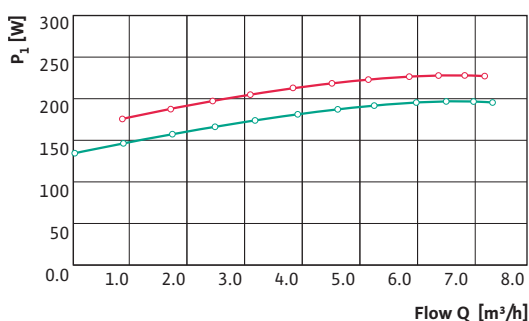

Change in the motor power due to higher fluid viscosity

## FUNDAMENTALS

### Instructions for preliminary pump selection with the specifications of the delivery head, rate of flow and the viscosity conditions.

When the desired flowrate and delivery head for the fluid, as well as the viscosity and relative density are given at a certain pump temperature, the following equations are used to find out an approximately equivalent power with water and to estimate the drive power of the pump for viscous fluids. Please observe that the results are less exact when you begin with the viscous conditions instead of with a known water performance for determining the required water performance, except when this involves repetitions.

#### Step 1

Calculate parameter **B** with the specified metric units  $Q_{vis}$  in  $m^3/h$ ,  $H_{vis}$  in m and  $V_{vis}$  in cSt with the help of equation:

$$B = 280 \cdot \frac{(V_{vis})^{0.50}}{(Q_{vis})^{0.25} \cdot (H_{vis})^{0.125}}$$

If  $1.0 < B < 40$ , go to step 2.

If  $B \leq 1.0$ , set  $C_H = 1.0$  and  $C_Q = 1.0$  and go directly to step 4.

#### Step 2

Calculate the correction factors for the flow ( $C_Q$ ) and the delivery head ( $C_H$ ). These two correction factors are approximately the same for a specified rate of flow if they are derived from the working point of the flow with water, optimised with respect to energy.  $Q_{BEP-W}$  Reference equation:

$$C_Q \approx C_H \approx (2.71)^{-0.165 \cdot (\log B)^{3.15}}$$

#### Step 3

For the approximate water performance, calculate the rate of flow and the delivery head of water:

$$Q_W = \frac{Q_{vis}}{C_Q}$$

$$H_W = \frac{H_{vis}}{C_H}$$

#### Step 4

Select a pump with a water performance of  $Q_W$  and  $H_W$ .

#### Step 5

Calculate the correction factor for the efficiency ( $C_\eta$ ) and the corresponding value for the pump efficiency with viscous liquids ( $\eta_{vis}$ ). Equation:

$$\text{For } 1.0 < B < 40: C_\eta = B^{-(0.0547 \alpha B^{0.69})}$$

$$\eta_{vis} = C_\eta \cdot \eta_W$$

#### Step 6

Calculate the approximate viscous input power of the pump shaft. For the rate of flow in  $m^3/h$ , the total delivery head in m and the input power of the shaft in kW, use the following equation:

$$P_{vis} = \frac{Q_{vis} \cdot H_{vis-tot} \cdot \rho}{367 \cdot \eta_{vis}}$$



### Required NPSH<sub>vis</sub>

The viscosity of the fluid has a two-fold influence on the NPSHR value. With increasing viscosity, the friction increases, which in turn leads to an increase in the NPSHR value. At the same time, a higher viscosity leads to reduced diffusion of air and vapour particles in the fluid. Thus, bubble formation is slowed down and there is also a thermodynamic effect, which leads to a slight reduction in the NPSHR value.

The effect of viscosity on the NPSHR value is basically a function of the Reynolds number. However, this effect cannot be expressed using a single relationship for all the different pump designs and models. As a general rule: Pumps with larger dimensions and consistent and wide impeller inlet openings are less susceptible when there are changes in the viscosity of the fluid.

Gas dissolved in the fluid and gas entrained by the fluid in the form of dispersed bubbles impair the NPSHR value in a manner different from that of large gas bubbles. When the flowrate at the inlet opening of the pump is high enough, small amounts of the entrained gas are not separated and usually have no or only a small effect on the NPSHR value. If, however, there are larger gas build-ups, this has a major effect on the pump suction. Then the NPSHR curves of the total delivery head change their shape from a well-defined "knee" to a step-like incline of the delivery head. This increases the point of the delivery head loss of 3 %, or in other words: The NPSHR value increases.

The equations here are used for calculating the correction factor for adjusting the NPSHR value for the pump water performance, based on a standard delivery head drop of 3 % on the NPSHR<sub>vis</sub> value with the corresponding viscous liquid:

$$C_{\text{NPSH}} = 1 + \left\{ A \cdot \left( \frac{1}{C_H} - 1 \right) \cdot 274\,000 \cdot \left[ \frac{\text{NPSHR}_{\text{BEP-W}}}{(Q_{\text{BEP-W}})^{0.667} \cdot N^{1.33}} \right] \right\}$$

A = 0.5 for lateral suction port

A = 0.1 for axial inlet

### Conversion to new delivery data by means of EDP support

The Wilo Select program is very recommendable for converting from water to other viscosities. A relatively exact calculation is made with the stored data. However, it must be observed that the known calculation method according to ISO/TR 17766 and the Hydraulic Institute etc. involve a tolerance. Exact specifications can only be determined by individually testing the pumps with the actual fluid at concrete operating conditions. To do this, a special job order must be given to the pump manufacturer.

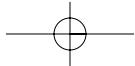
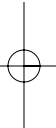
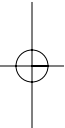
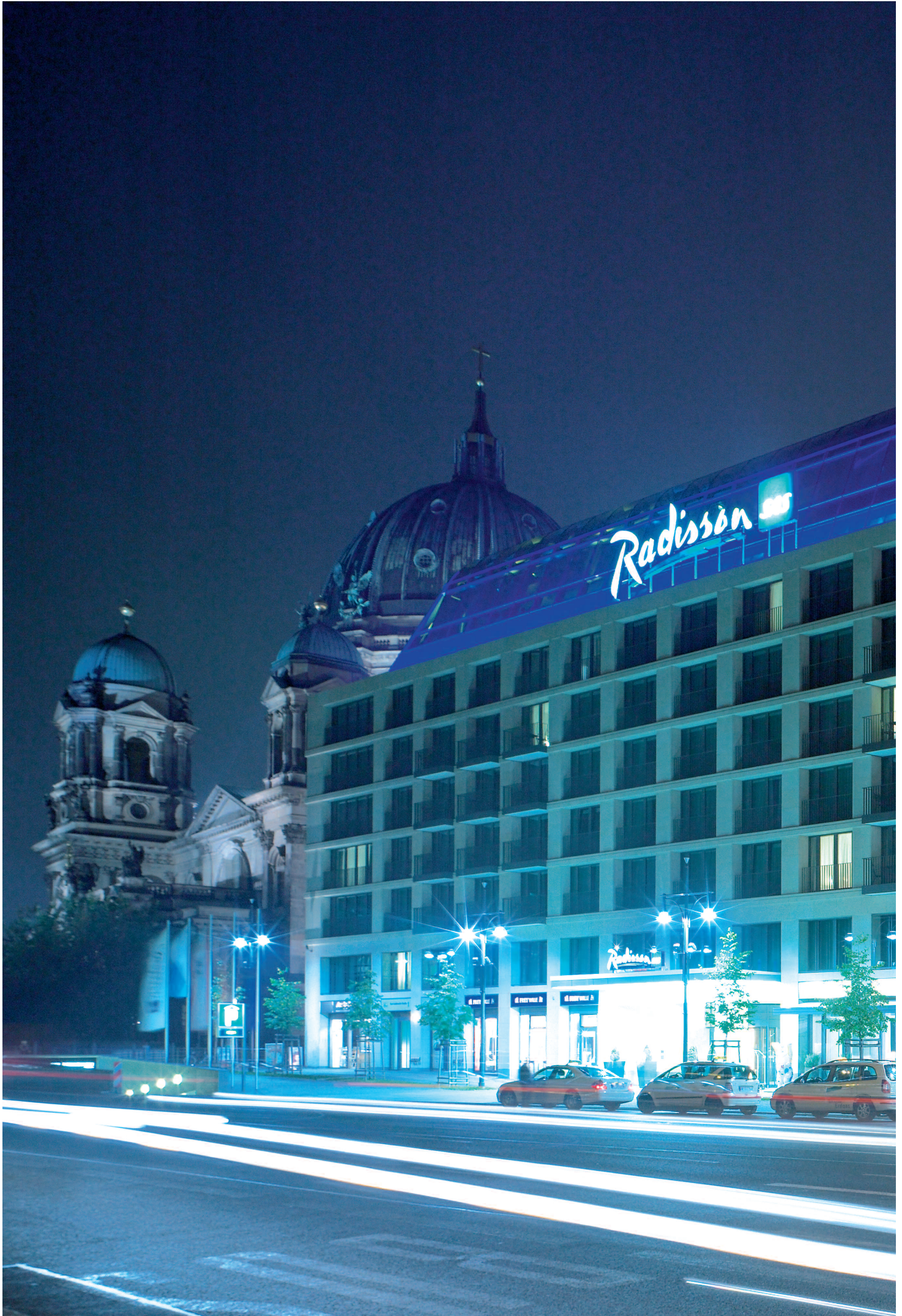
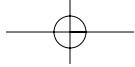

# Noises – Airborne sound – Structure-borne sound

To prevent or reduce potential bothersome noise, the pump operation in residential building systems requires special attention in the selection of suitable pumps / in the planning and execution of the installation.

Especially in residential buildings, the problem of noise reduction plays a major role in comfort demands, especially during the night hours.

For the permitted noise level value in common areas, the following regulations are to be observed:

- DIN 4109, Noise protection in building construction
- VDI 2062, Vibration insulation
- VDI 2715, Noise reduction in warm and hot-water heater systems
- VDI 3733, Noises in pipelines
- VDI 3743, Emission characteristics of pumps

## Pumps as noise generators

It is unavoidable that pumps make noise. Wilo as a manufacturer is doing its best to deliver pumps which are as quiet as possible.

In residential building systems, centrifugal pumps are mostly used. The noise they make can basically be divided into the following main groups:

### Flow noise

The flow noises have various causes. A noise having a large frequency range, which sounds like hissing, is caused by the turbulence and friction of the water particles on the surface of the parts being flowed through.

Frictional processes also cause an irregular speed distribution in the boundary layer, which can result in alternating movements of the water flow off the pipe wall causing subsequent turbulence formation. This periodical vortex shedding creates a more or less pronounced single sound.

Furthermore, the speed of the flow fluctuates after it leaves the impeller. These irregularities lead to noise being generated in the connected pipes. Since the frequency of these noises depend on the pump rotation speed and the number of blades, one refers to the blade frequency of the pump.

### Cavitation noise

The cavitation noises in a pump are caused by the formation and the sudden collapse of vapour bubbles in flowing water.

### Noise due to mass forces

Vibrations, excited by mass forces, which lead to noises, are caused by imbalances in rotating parts (impeller, shaft, coupling, etc.). Despite the most modern balancing technology, the imbalance comes from alternating bearing forces, production imprecisions or material wear or accretion. The frequency of imbalance vibrations is always the same as the rotational frequency of the rotating parts.

### Noise due to friction on bearings and sealed places.

Vibrations caused by friction on bearings and seals, which lead to noise, are not that important when the pumps are working properly.

### Electromotor noise

Pumps are usually driven by electromotors in residential building systems. The noise which comes from the electromotor only belongs to the pump noise when the pump and electromotor are designed in a block. In the electromotor, sounds are caused by electromagnetic processes at double the mains frequency (100 Hz) and, depending on the number of poles, mostly between 600 and 1200 Hz. Noise with a high frequency range is produced by the fan of the motor, similar to the pump, which is superimposed with the blade frequency of the fan as a single sound.

### Other noises

Furthermore, rolling noises from the ball bearings as well as whistling noises on the dry-running packing glands and mechanical seals can occur.

## NOISES – AIRBORNE SOUND – STRUCTURE-BORNE SOUND

### Airborne noise

The airborne noise which comes directly from the pump can be heard in the boiler room. In the neighbouring lounge areas, however, it can hardly be heard when ceilings and walls of the boiler room are built according to DIN 4109. At the usual sound-damping dimension, the figure to the right can be referred to for assessing permitted airborne noise levels.

If the octave spectrum of the circulating pump doesn't go over the limit at any frequency, then the airborne noise of the transmitted noise also remains under 30 dB in the lounge areas.

Limit for the octave spectrum

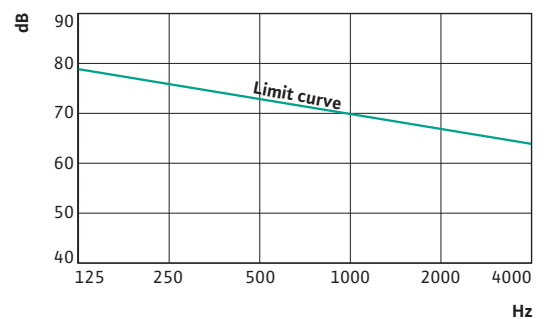

### Structure-borne sound and waterborne sound

Completely different conditions may arise through the transmission of structure-borne and waterborne sound. If pump noises can be noticed outside of the installation room, it is very probable that this is the transmission of structure- and/or waterborne sound via the building structure along the pipeline. Along the pipeline, waterborne noise spreads out via the water column and structure-borne sound via the pipe wall in the pipework. Practice shows that they usually occur together.

Structure- and waterborne sound are not directly discernible by the human ear. Only when waterborne noise makes the pipe wall vibrate, causing the surrounding air to vibrate, there is an audible airborne noise.

This property of not being directly discernible, which is to be considered favourable, is far outweighed by the unfavourable property of the nearly lossless conduction via the pipeline system. Pipelines are well suited for transmitting vibrations due to their elasticity, and therefore make up an ideal transmission system for noises. In the case of resonance, the noise is not only relayed, but even amplified. Like all elastic bodies, even pipelines have so-called resonance frequencies, which depend on various factors. If this pipeline resonance frequency should

happen to be identical with the excitement frequency coming from the circulating pump, it begins to resonate. Here, a very low excitement energy is enough to make the pipeline strongly vibrate. This also means that there is strong noise development. Vibration tests have shown that resonance frequencies can occur in high numbers in systems designed in the frequency range of interest (between 50 and 1000 Hz). Thus, the possibility of resonance occurring is always there. It is not possible to do a precalculation of pipeline resonance frequencies due to the complex relationships.

In the case of disturbances in the residential area, which are caused by noises in residential building systems, the main difficulty is the transmission of structure-borne and waterborne noise via the pipe system. Therefore, measures have to be taken to prevent the unhindered transmission of structure-borne and waterborne noise. The VDI directive 2715 provides a few valuable tips here.

#### Structure-borne noise via the building structure

If a pump is directly connected with the building structure, this can be made to vibrate. Furthermore, vibrations can be introduced to walls and ceilings via pipe fixtures.

## Measures against noises

A major precondition for the effective and sensible protection against noise from pumps which are installed in residential building systems is the cooperation of all parties involved in creating the building. Architects and planners are given the task to select floor plans so that favourable acoustic conditions can be created. Thus, rooms or components with noise-generating apparatuses, such as home technical systems, should be placed as far as possible from the living areas.

The operating behaviour of the pump is influenced by the connected pipelines and other system parts; this also has an effect on the noise transmission. The relationships are so manifold, so that no simple rules can be established, where one can say with certainty that noises can be completely ruled out.

The following items should always be observed when selecting a pump:

- Pumps should be operated at the point of the best efficiency, if possible.
- This demand can be best met by not making any exaggerated safety allowances in the pressure loss calculation.

### Aspects for determining and selecting pumps

Pumps should be operated at the point of optimum efficiency since then the optimum is not only reached in max. economic efficiency, but also in noise behaviour. Then, it is often possible to go without additional noise-reducing measures. Often, in the designing of pumps for home automation systems, the safety allowances are made much too high for the system resistance. This leads to an unnecessarily large pump being selected, which is then not operated at the point of optimum efficiency. Based on experience, a large percentage of noise complaints are a result of this error. In selecting a suitable pump, it is important to know that pumps with low speeds generally demonstrate more favourable noise behaviour.

### Measures for avoiding flow noises due to pipeline conduction

In the development of flow noises in a system made up of a pump and pipeline, the pipeline conduction and rate of flow play significant roles.

#### Flowrate

It is to be observed that the nominal pipeline diameter is usually equal to or greater than the nominal connection width of the pump.

Required cross-sectional modifications are to be designed favourable to flow and centrally.

The table below contains nominal width-related recommendations for flow rates in the connection of the pump, which should not be exceeded in order to avoid noise.

The pipeline on the pump inlet side should run straight over a length of at least  $5 \cdot d$  in order to provide favourable hydraulic conditions at the impeller inlet.

Nominal connection widths DN Ø mm	Flowrate v m/s
<b>In building installations</b>	
Up to 1 1/4 or DN 32	up to 1.2
DN 40 and DN 50	up to 1.5
DN 65 and DN 80	up to 1.8
DN 100 and greater	up to 2.0
Long-distance lines	2.5 to max. 3.5

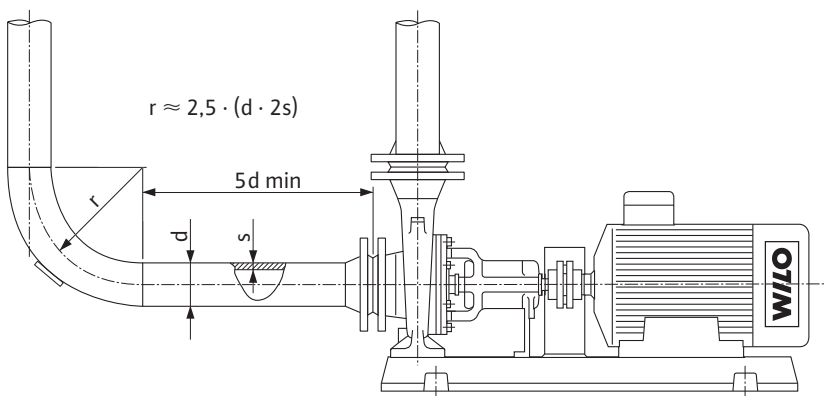

## NOISES – AIRBORNE SOUND – STRUCTURE-BORNE SOUND

When the pipe diameter is reduced, sudden cross-section changes are to be avoided. This is possible using conical adapters. If the formation of air pockets can be expected, eccentric adapters are preferable.

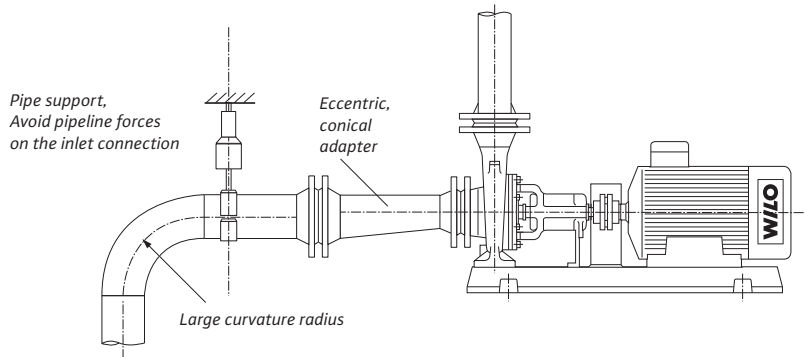

Fittings should not be installed in the pipeline directly after the pump connection, especially not on the entry side of the pump. Here, a minimum distance of  $5 \cdot d$  also has a favourable effect on noise creation.

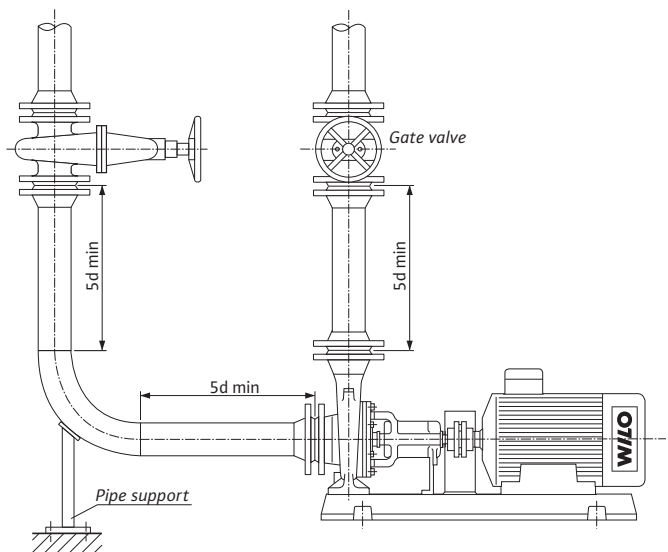

### Measures against waterborne and structure-borne sound propagation via pipelines

Introducing waterborne and structure-borne noise in pipelines can be prevented by special damping measures on the pump to the pipelines. A remarkable noise-reflecting effect from pipeline direction changes is not expected with the wavelengths of the water-borne sound in home systems and the dimensions of the pipelines.

When sound-absorbing measures are taken, it is to be made sure that the operating safety of the pump isn't impaired, i.e. functionally reliable damping elements must be selected. The following expansion joints come into question as absorbing elements:

- Expansion joints with length limitation without elastic elements (lateral expansion joints)
- Expansion joints with length limitation with elastic elements as well as rubber metal flanges
- Expansion joints without length limitations

For expansion joints with length limitation without elastic elements, no additional pipeline forces act on the pump connection. But on the other hand, these expansion joints have only a slight absorbing effect. Expansion joints without length limitations have the greatest absorbing effect. With these, however, the largest additional pipeline forces act at the same time. The pipeline forces can theoretically reach 16 000 N for a pump with a nominal diameter of 100 and nominal pressure of 10. Practically speaking, however, due to the limited elasticity of the expansion joints, only pipeline forces up to half this value can act. No generally valid statements can be made at this time with regard to what connection forces are permissible.

## NOISES – AIRBORNE SOUND – STRUCTURE-BORNE SOUND

The expansion joint with elastic length limitation is the "reasonable" compromise between noise absorption and connection forces in many applications. When absorbing elements are used, their limited service life and sensitivity to hot water are to be observed.

### Expansion joints

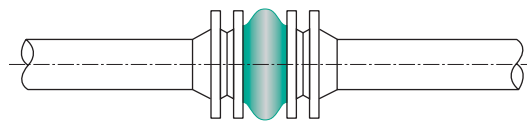

*Expansion joint without length limitation*

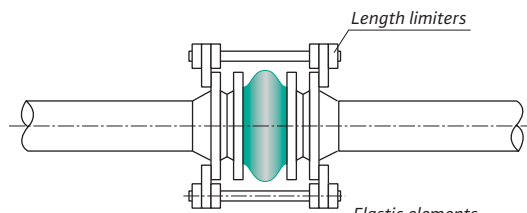

*Expansion joint with length limitation without elastic elements (lateral expansion joint)*

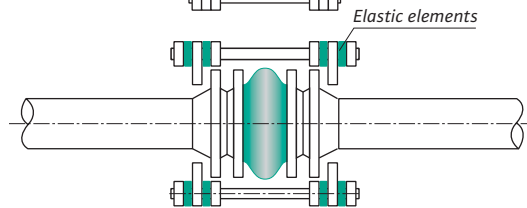

*Expansion joint with length limitation with elastic elements*

The effectiveness of the absorbing measures can be seen in the figures on page 24, which show oscillograms of structure-borne noise measurements on a pipeline made to vibrate by a heating circulation pump. Depicted are three different cases of structure-borne noise, which include the unfiltered measuring signal and the filtered-out low- and high-frequency portions, i.e. their blade frequency of 150 Hz (4-pole electromotor, impeller with six blades) or the electromagnetic frequency of 600 Hz.

In the first case, the state is shown with the pipeline connected with the pump. In the second case, the state is shown after the installation of rubber/metal pipe connectors on the inlet and outlet sides. As can be seen, the high-frequency portions are considerably reduced. By installing rubber expansion joints (third case), both the high-frequency and low-frequency portions are greatly reduced.

Whether the absorbing measures in cases 2 and 3 are appropriate for the individual case depends on the frequency of the dominant system noise.

The absorbing measures described using the example of pumps having in-line construction can be also applied sensibly for pumps set up on the floor.

## NOISES – AIRBORNE SOUND – STRUCTURE-BORNE SOUND

### Expansion joints

**Case 1**  
Rigid installation,  
no absorbing effect

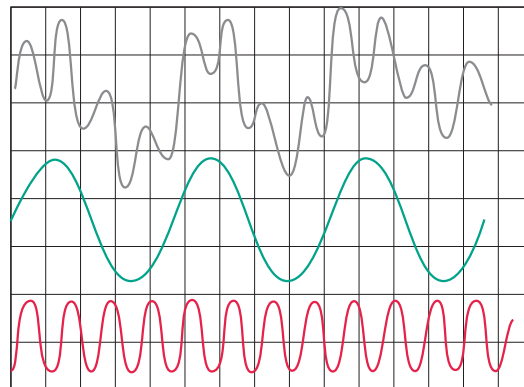
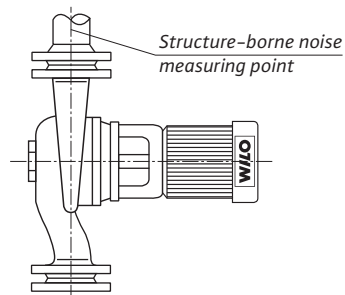

**Case 2**  
Only the high-frequency  
noise (600 Hz) is reduced  
with rubber/metal pipe  
connectors.

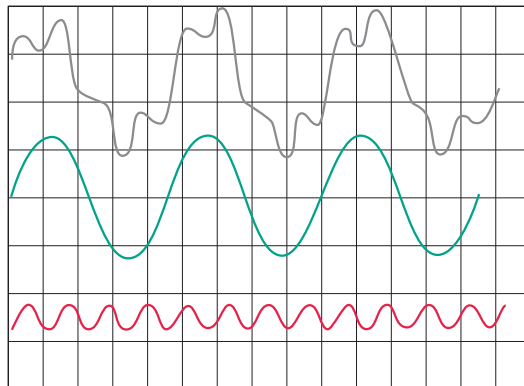
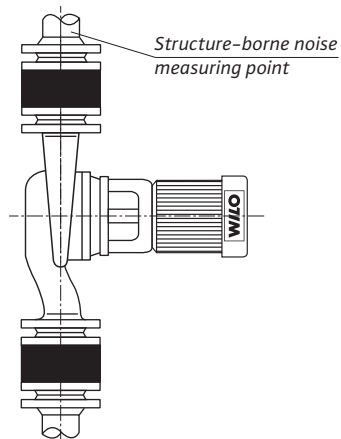

**Case 3**  
The high-frequency noise  
(600 Hz) as well as the low-  
frequency noise (150 Hz) is  
reduced by rubber expansion  
joints.

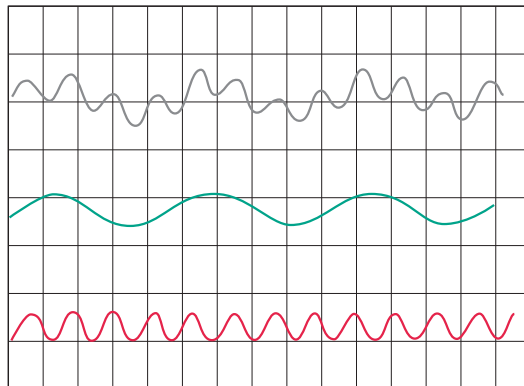
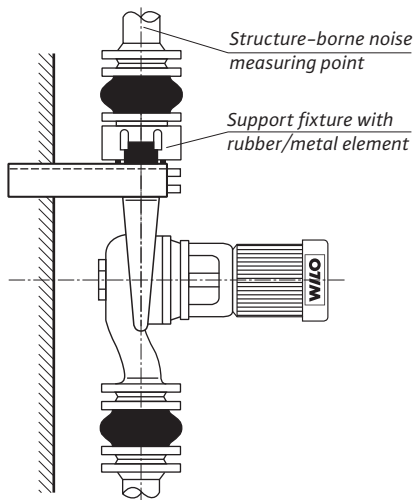

**Key:**  
top: Overall measuring signal  
centre: low-frequency noise (150 Hz)  
bottom: high-frequency noise (600 Hz)



## NOISES – AIRBORNE SOUND – STRUCTURE-BORNE SOUND

### Measures against structure-borne noise transmission to the structure

When pumps are set up on the floor, in order to suppress structure-borne noise transmission, it is also often required to support them with elastic elements between the baseplate and floor in addition to vibration insulation from the pipelines. This way, vibration transmission to the structure is prevented. If pumps are set up on floor slabs, the elastic support is absolutely recommendable. Special care must be taken with pumps having varying speed.

The elastic elements are to be selected according to the lowest excitement frequency (this is usually the speed). The spring stiffness must decrease with decreasing speed. In general, natural cork plates can be used for a speed of 3000 rpm and more, for a speed between 1000 and 3000 rpm rubber/metal elements can be used, and for a speed under 1000 rpm, spiral springs. When pumps are set up on the basement floor, often plates made of natural cork, mineral wool or rubber can be used as an elastic base.

In the figure it is shown how the vibration damping of a pump unit is to be designed. The absorption effect depends on the resonance frequency of the elastically supported pump unit. Put simply, the resonance frequency is determined from the weight of the pump unit and the spring stiffness of the elastic elements.

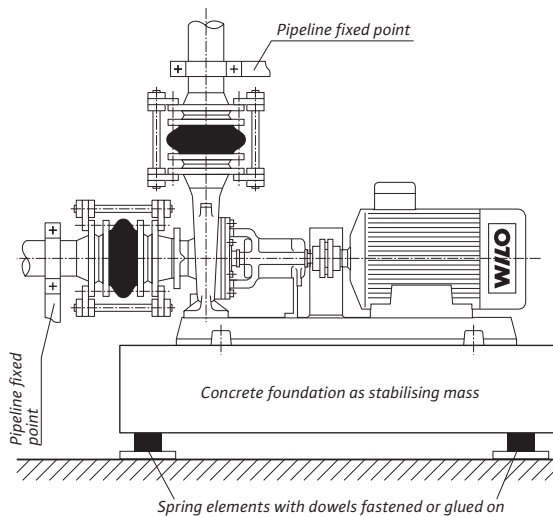

The resonance frequency of the system  $f_0$  can be seen in the diagram below.

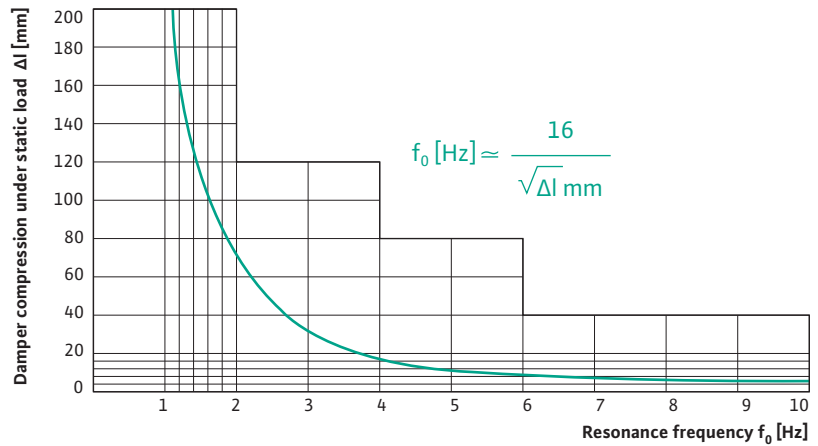

In order to achieve good absorption, the resonance frequency of the system  $f_0$  must lie considerably below the excitement frequency from the pump  $f_{err}$ .

In the case of pumps which don't have balanced mass forces, the oscillation amplitude can be reduced by increasing the foundation mass.

**NOISES – AIRBORNE SOUND – STRUCTURE-BORNE SOUND**

**Pipe suspension**

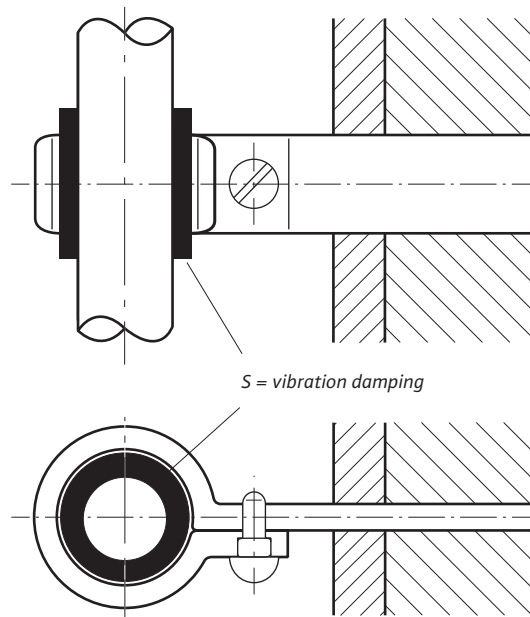

When designing the elastic support, make sure that no acoustical bridges are created. Therefore, bypassing the elastic support with plaster or tile is to be avoided. Every impairment in the freedom of movement of the pump unit ruins the absorption effect or at least reduces it considerably.

When laying the pipe it is to be made sure that there is never a fixed, rigid connection with the building structure. The pipe fixtures should be insulated from structure-borne noise. This is especially to be made sure when installing pipes in the wall. Suitable prefabricated fixing elements are available in special stores.

Special attention is to be given to pipe feed-throughs through walls and ceilings. There are also prefabricated collars available in special stores which meet all requirements for good insulation against structure-borne noise.

**Structure-borne noise-absorbing pipe feed-through**

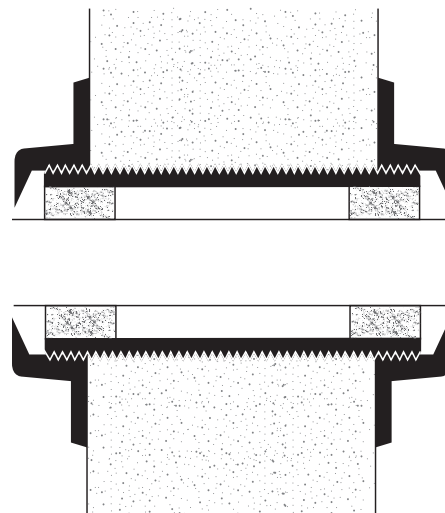

The pipe insulation against structure-borne noise with respect to the building structure must be executed with great care since every mistake, even at only one place, can ruin the entire insulation effort.

### Pressure on the suction port of the pump

Sufficient pressure on the suction port of the pump should prevent cavitation on the impeller. Cavitation is the formation and sudden collapse of vapour bubbles. The vapour bubbles form in places where the pressure of the flowing fluid drops until the value of the vapour pressure reaches the value which the fluid has at the prevailing temperature. The vapour bubbles are carried off with the flow and collapse when the pressure increases above the vapour pressure further along the flow path.

Cavitation must be avoided since the flow rate, noise behaviour and smooth pump operation are negatively influenced and can even lead to material damage.

To keep these faults from occurring during operation, the "minimum required net head" at the inlet of the pump is required (see pump catalogue). This NPSH value depends on the flow in every pump. Each pump size has its own NPSH curve at a given speed, which was determined by the pump manufacturer by means of measurement. The planner must provide an "NPSH system" in the system, which is equal to or greater than the NPSH value of the pump at the most unfavourable duty point. The figure shows the value of the overpressure compared to the atmospheric pressure which must at least be available at the pump suction side, shown vs. the NPSH value of the pump.

The figure indicates the minimum required overpressure with respect to the atmospheric pressure which must be available at the suction port of the pump. The curves apply for a maximum flow rate of 2 m/s and for an installation altitude of 100 m above sea level.

For installation altitudes higher than 100 m, the read-off value  $P_E$ , which depends on the NPSH value of the pump and the water temperature, is to be corrected. The following applies:

$$P^* = P_E + X \cdot 0.0001$$

The value X is the real altitude (in m) of the installation site, measured above sea level.

Required inlet pressure depending on temperature

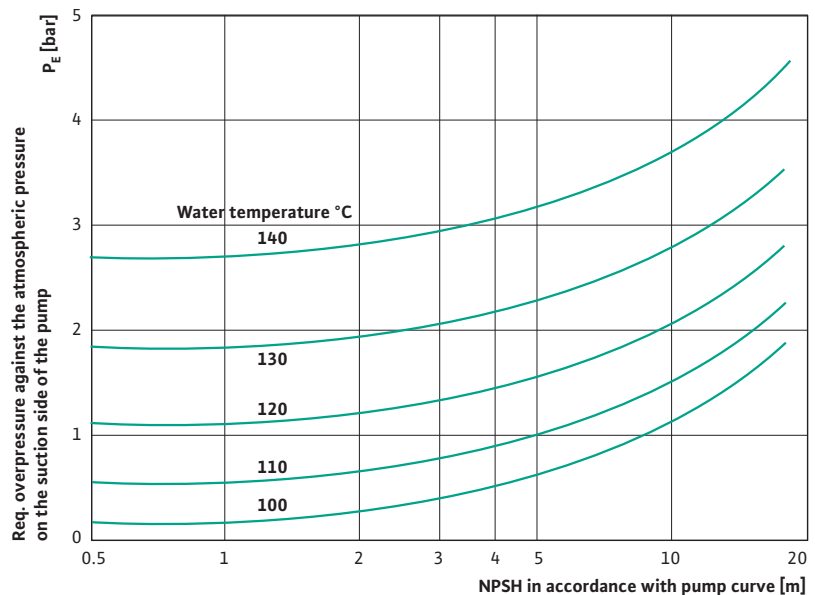

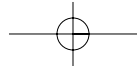
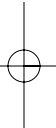
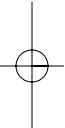
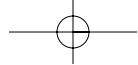

# Pump intake

## Pump sump

A pump sump is required when there is irregular intake and pumping off of the delivered fluid. The size of the sump depends on the pump flow and the permissible switching frequency of the electromotor. The useful volume of the pump sump is calculated with :

$$Q_m = \frac{Q_e + Q_a}{2}$$

$$V_N = Q_{zu} \cdot \frac{Q_m - Q_{zu}}{Q_m \cdot Z}$$

Any backflow volume is to be added to this, if necessary.

If contaminated fluids are used, it must be avoided that solid matter gets deposited on the floor. This can be avoided with inclined walls of at least 45°, or better 60°.

To avoid turbulence and the formation of shearing forces due to irregular intake, an impact surface in the pump sump is recommendable.

### Abbreviation Description

Abbreviation	Description
Z	maximum permissible number of switches per hour
$Q_{zu}$	Delivery in m <sup>3</sup> /h
$Q_e$	Flow at the switching-on point in m <sup>3</sup> /h
$Q_a$	Flow at the switching-off point in m <sup>3</sup> /h
$V_N$	Useful volume of the pump sump in m <sup>3</sup>

### Suction tank

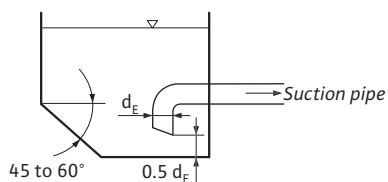

### Pump sump with impact surface

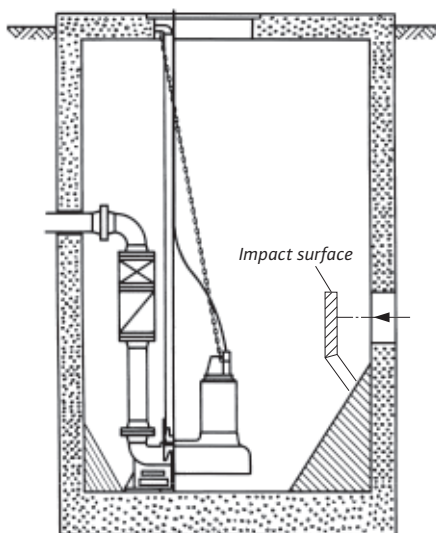

**PUMP INTAKE**

**Suction lines and suction tanks**

**Suction tank with impact surface**

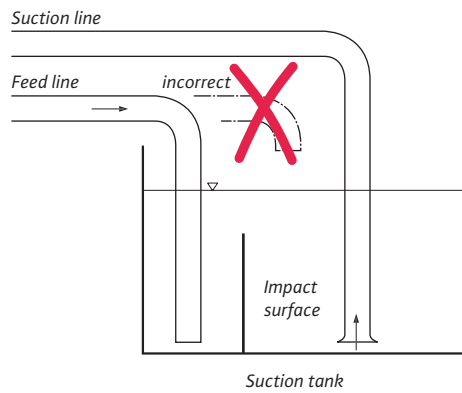

In order to prevent air or turbulence from entering the suction line, the distance between the suction and inlet lines must be sufficiently large. Also, impact surfaces should be included. The inlet pipe must always enter under the fluid level.

Also, it must be made sure that there is a sufficiently high fluid coverage over the suction opening. When there is insufficient coverage, turbulence caused by air suction can result. Beginning with a funnel-shaped depression in the fluid level, an air hose forms from the surface to the suction line. This results in turbulent flow and a drop in pump performance.

For an exact calculation, the following formula is to be used according to the Hydraulic Institute:

**The minimum distances of the suction line from walls and tank floor:**

DN	25	32	40	50	65	80	100	150	200
B in mm	40	40	65	65	80	80	100	100	150

$$S_{min} = d_E + 2.3 \cdot v_S \cdot \sqrt{\frac{d_E}{g}}$$

**Abbreviation Description**

$S_{min}$	Minimum submergence in m
$v_S$	Rate of flow = $Q/900 d_E^2$ in m/s, recommended 1 to 2 m/s but not > 3 m/s
Q	Flow in m <sup>3</sup> /h
g	Gravitational acceleration 9.81 m/s <sup>2</sup>
$d_E$	Inlet diameter of the suction pipe or the inlet nozzle in m

**Suction and minimum distances**

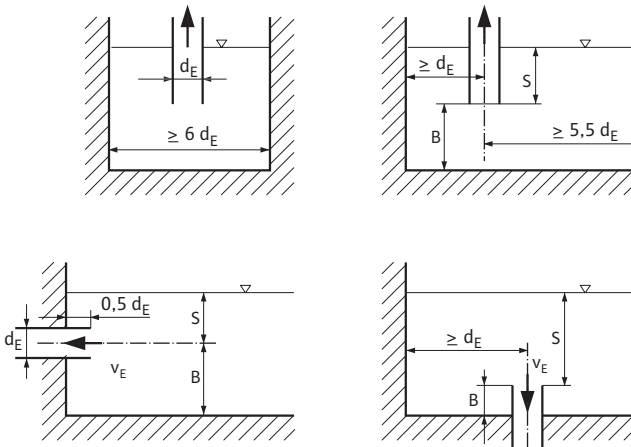

If the minimum submergence can't be provided, floats or swirl-preventing conductor surfaces are to be provided to prevent turbulence caused by air suction.

**The minimum submergence  $S_{min}$  for the recommended flow rates of 0.5 to 3 m/s are:**

DN	25	32	40	50	65	80	100	150	200
$S_{min}$ m	0.25	0.35	0.65	0.65	0.70	0.75	0.80	0.90	1.25

**Suction tank and float**

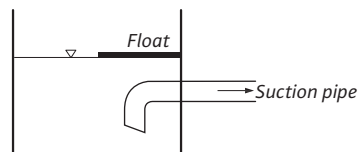

## Suctioning

The standard circulation pumps are not self-priming. This means that the suction line and the pump housing on the suction side have to be vented so that the pump can work. If the pump impeller is not under the fluid level, the pump and suction line must be filled with fluid. This tedious procedure can be avoided when the inlet of the suction pipe is equipped with a foot valve (non-return valve). Venting is only required at the initial commissioning or when a fitting is leaky.

### Foot valve

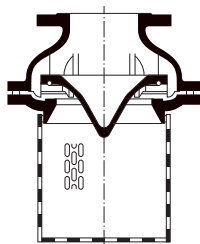

### Suction operation

Due to losses in the connection lines, pump and fittings, a maximum of 7 to 8 m suction head can be achieved in practice. The head difference is measured from the surface of the water level to the pump suction port.

Suction lines are to be installed which have at least the nominal diameter of the pump port, but if possible, should be one nominal diameter larger. Reductions are to be avoided. Especially fine filters must be kept away from the suction side. The suction line is to be installed so that it has a continuous incline to the pump and a foot valve (floating discharge) is to be installed which prevents the line from running empty. The line should be kept as short as possible. In long suction lines, increased friction resistances arise which strongly impair the suction head.

Air pocket formation caused by leaks are to be avoided under all circumstances (pump damage, operating faults).

When hose lines are installed, suction- and pressure-proof spiral hoses should be used.

### Suction line installation

*correct*

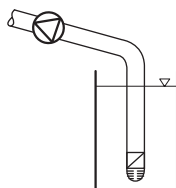

*incorrect*

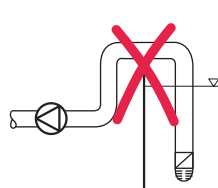

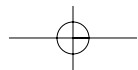
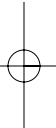
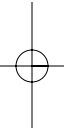
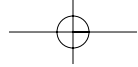



# Pump performance control

The volume flow conveyed through a circulating pump is dependent on the thermal output/cooling output requirement of the system being supplied. This requirement fluctuates depending on the following factors:

- Climatic changes
- User behaviour
- Extraneous heat influence
- Influence of hydraulic control devices, etc.

The circulating pump designed for maximum load status is adapted by means of a continuous setpoint/actual-value comparison to the relevant system operating state. This automatic control serves to adapt the pump performance and thus also the power consumption continuously to the actual requirement/demand.

Electronically controlled pumps from Wilo are able to control the mass flow automatically. This can help avoid throttling and makes an adjustment to the system duty point possible. In addition to the reduced power consumption of the pump, throttling elements can also be done without. This way, additional installation and material costs can be noticeably reduced.

The same result can be achieved with Wilo control devices which aren't directly mounted on the pump.

## Control mode $\Delta p$ -c

In the  $\Delta p$ -c control mode, the electronics circuitry maintains the differential pressure generated by the pump constant at the setpoint value  $H_S$  over the permitted volume flow range.

### $\Delta p$ -c control

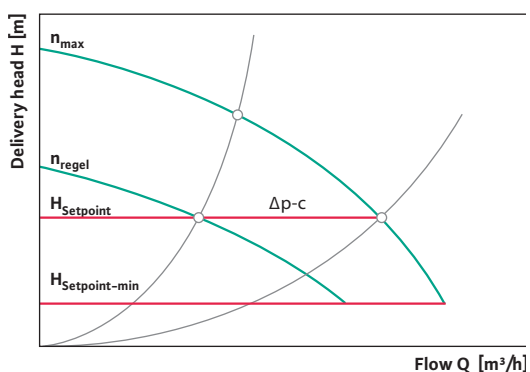

I. e., any reduction of flow volume (Q) due to throttling of the hydraulic regulating devices will in turn decrease the pump performance to match actual system demand by reducing the speed of the pump. In parallel with speed alteration, the power consumption is reduced to below 50 % of the nominal power. The application of differential-pressure control requires a variable flow volume in the system. Peak-load operation, e.g. in conjunction with a twin-head pump, will be effected automatically and load-sensitively. If the capacity of the controlled base-load pump becomes insufficient to cover the increasing load demand the second pump will automatically be started to operate in parallel to cover the risen demand. The variable speed pump will then be run down until reaching the preset differential-pressure setpoint value.

It is generally recommended to pick off the differential-pressure directly at the pump and to maintain it there at a constant level. An alternative would be to install the signal transmitter in the system – as a remote signal transmitter in the so-called index circuit of the system (control-range extension). Operation with a remote signal transmitter will partly allow much larger speed reductions and thus pump performance reductions. It is essential in this respect that the selected measuring point is valid for the consumption performance of all the system sections. Where this calculated measuring point in the index circuit may be subject to shifting to other parts of the pipe system, optimisation by means of the Wilo DDG impulse selector is preferable. Measuring points ranging from 2 to 4 can be compared on a continuous basis. Only the lowest measured value forms the basis for the setpoint/actual value comparison by the CR controller.

### Control curve for remote signal transmitters

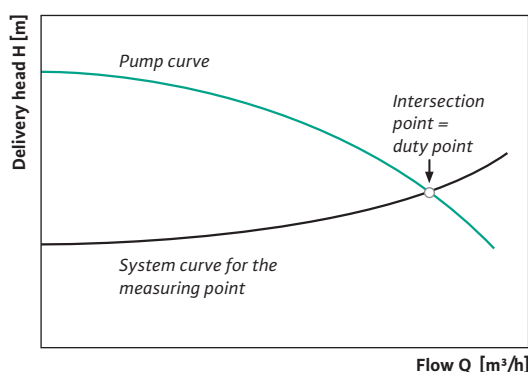

## PUMP PERFORMANCE CONTROL

### $\Delta p$ -v control mode

When refurbishing or upgrading existing systems it is not always possible to evaluate the point in the circuit which shows the lowest differential pressure. Original installations have been completed years ago and now, after installing individual room controls, noise problems have developed. The index circuit of the system is not known or it is not possible to integrate new sensor connections. A control-range extension is nevertheless possible using the  $\Delta p$ -v control mode (recommended for single-pump systems).

In the  $\Delta p$ -v control mode, the electronics change the differential pressure setpoint to be kept by the pump linearly between  $H_S$  and  $1/2 H_S$ . The differential pressure setpoint  $H$  changes with the flow  $Q$ .

#### $\Delta p$ -v control

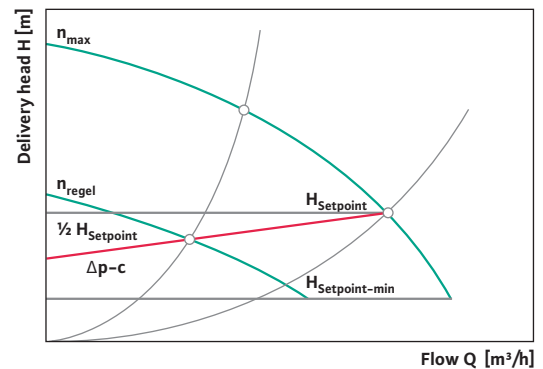

### Differential pressure – delivery-superimposed ( $\Delta p$ -q)

In order to avoid the time and expenditure associated with index-circuit evaluation (extensive and expensive cable routing, amplifiers, etc.), it is possible to superimpose the setpoint differential-pressure value directly with a signal proportional to delivery. Using this method, it is possible even with multi-pump systems to achieve a control-range extension in spite of central measured-value acquisition (differential pressure sensor at the pump). This method requires, in addition to the differential pressure sensor which is to be fitted directly on the pump system, the cooling-circuit output or the input of the consumer rail, the onsite provision by the customer of a volume-flow transmitter (0/4–20 mA) to be installed in the system's main feed pipe.

The use of  $\Delta p$ -q control is recommended for such systems whose index circuit or system performance is not known or in such cases where long signal distances cannot be bridged, particularly for such systems where volume-flow transmitters are already available.

#### Differential pressure – delivery-superimposed ( $\Delta p$ -q)

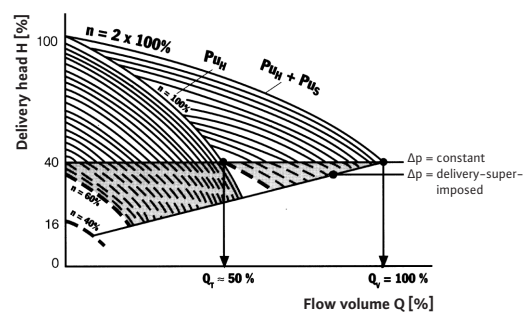

## $\Delta p$ -T control mode

In the  $\Delta p$ -T control mode (programmable only with the IR-Monitor) the electronics circuitry varies the setpoint differential pressure value to be maintained by the pump as a function of the measured fluid temperature. This temperature-prompted differential-pressure control mode can be used in constant-volume (e.g. one-pipe systems) and variable-flow systems with varying feed temperature. Conversely, the  $\Delta p$ -T control mode supports heating pump technology, provided the pump is installed in the return pipe of the system.

### $\Delta p$ -T control

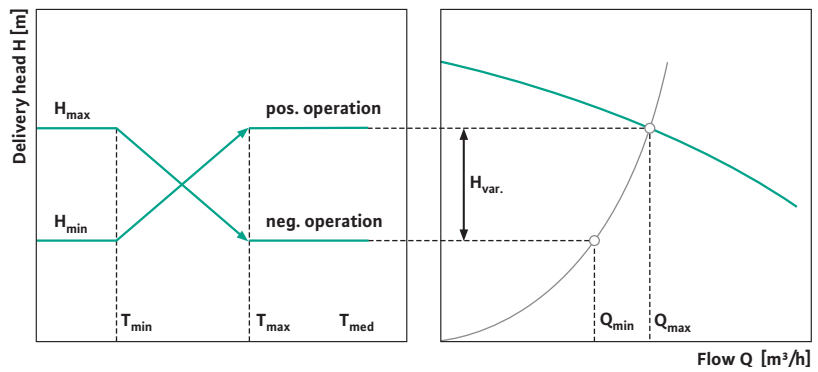

## DDC operating mode

In this mode the actual/setpoint level assessment required for control is referred to a remote controller. An analogue signal (0...10 V) is fed as a manipulated variable from the external controller to the Wilo pumps with built-in electronic circuitry. The current speed is shown on the display, and manual operation of the pump is deactivated.

DDC operation always means that a signal from the higher-ordered controller must be registered by the Wilo products. In addition, floating contacts for switching on-/off, etc. are required, depending on the used product. Also, floating signals or 0...10 V (0/4-20 mA) signals can be used by the Wilo products for monitoring and logging. Details can be found in the product catalogues.

### DDC pump operating mode with built-in electronic circuitry

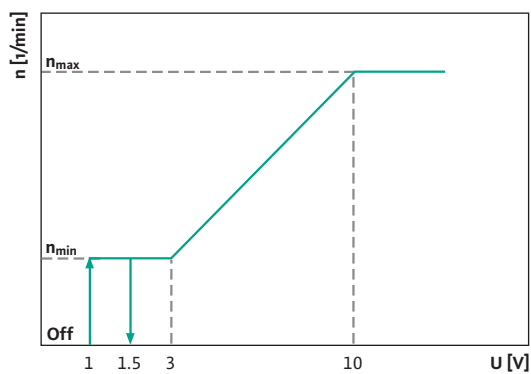

### DDC operating mode with Wilo switchgear

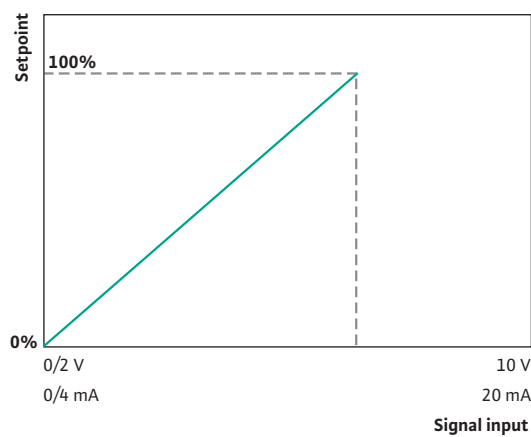

When a Wilo control device is used, the setpoint depends on the used signal transmitter. When the signal transmitter DDG 40 is used, this means, for example, that the setpoint at 0 % is equal to zero meters and at 100 % is equal to 40 meters. Analogously, this applies for all other measuring ranges.

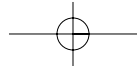
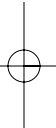
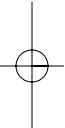
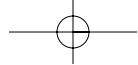

# Generator circuits in the liquefier part

On the generator side, one distinguishes between the cooling circuit in open and closed systems. Thus, using a suction well and sinkhole, ground or river water can be utilised for the primary circuit. Or the hot side of the generator is cooled with the air. By means of heat recovery, it is also possible to heat parts of buildings at the same time.

## Cooling tower/emergency cooler

Submersible pumps supply the condenser directly with well water. The pumps could also be installed in a river or a reservoir. The submersible pumps must be resistant to water corrosion. They are dimensioned from the delivery head for the total pressure losses in the condenser circuit and the geodetic head difference between the well floor and the highest point in the vaporiser system.

Submersible pumps supply the plate heat exchanger directly with well water. The pumps could also be installed in a river or a reservoir. By using stainless steel and/or plastic material on the primary side of the exchanger, corrosion damage can be avoided. The refrigerating machine can be made out of the usual materials. They are dimensioned from the delivery head for the total pressure losses in the condenser circuit and the geodetic head difference between the well floor and the highest point in the heat exchanger system.

A cooling tower with collection tray, usually installed on top of the building, takes over heat dissipation out of the condenser. Due to the constant oxygen supply, pumps made of red brass or plastic material should be selected. If there is continuous water conditioning, normal cast-iron designs can also be used. They are dimensioned from the delivery head for the total pressure losses in the condenser circuit and the geodetic head difference between the well floor and the highest point in the nozzle fitting of the cooling tower.

Since this is a closed circuit, standard material can be selected. The first filling is to be done with water according to VDI 2035 etc. to protect against deposits and corrosion.

### Ground water for direct utilisation in the condenser

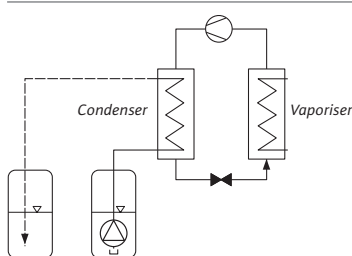

### Ground water for indirect utilisation in the condenser

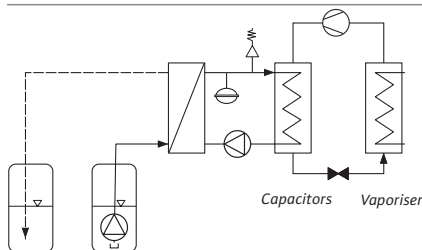

### Open cooling tower system

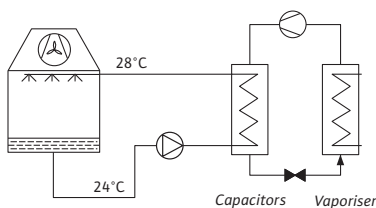

### Closed cooling tower system in the condenser circuit

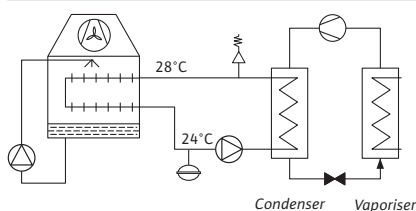

## GENERATOR CIRCUITS IN THE LIQUEFIER PART

### Heat recovery

#### Indirect heating with cooling water

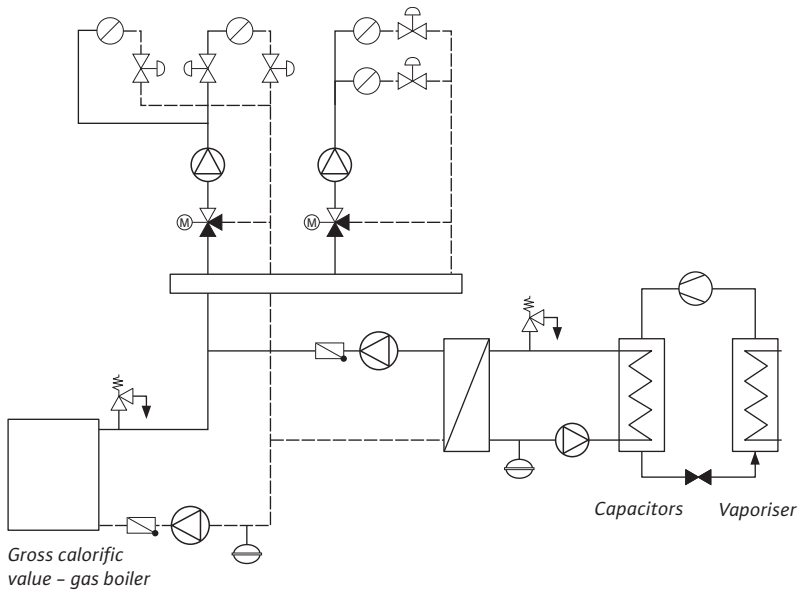

The cooling water warmed up in the condenser of the refrigerating machine is used for heating tasks via a heat exchanger. Due to galvanic insulation, the pump in the condenser circuit is only to be designed for these pressure losses. The material selection is arbitrary due to the closed circuit. If an emergency-cooler is added to the condenser circuit, the pump is to be determined based on its requirements and there must be hydraulic balancing between the heat exchanger and emergency cooler. To protect against corrosion, the emergency cooling only makes sense as a closed cooling tower.

#### Direct heating with cooling water

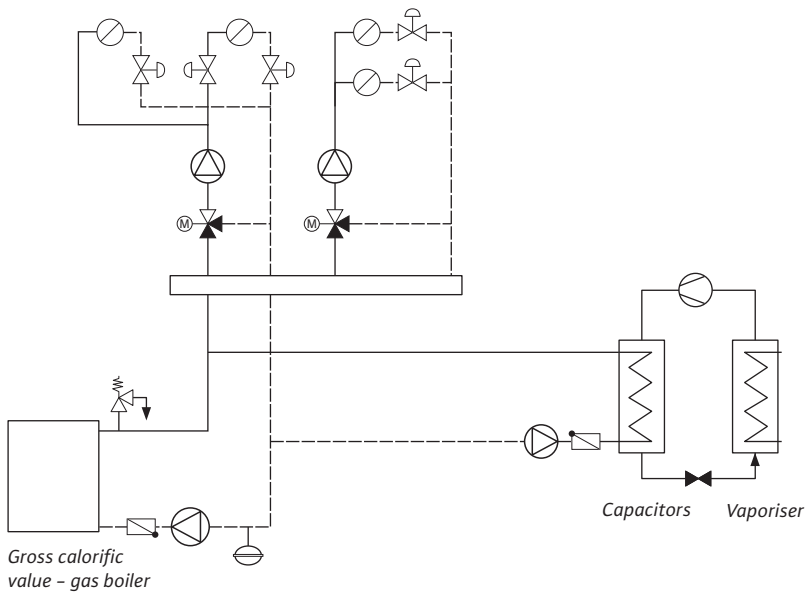

The cooling water warmed up in the condenser of the refrigerating machine is used directly for heating tasks. Due to the direct connection, the pump in the condenser circuit is only to be designed for the pressure losses in the condenser and pipeline up to the distributor/collector. The material selection is to be adapted to the heating circuit. If an emergency-cooler is added to the condenser circuit, the pump is to be determined based on its requirements and there must be hydraulic balancing between the heat exchanger and emergency cooler. It's better to supply the emergency cooler with its own pump circuit. To protect against corrosion, the emergency cooling is only possible as a closed cooling tower.

## GENERATOR CIRCUITS IN THE LIQUEFIER PART

### Geothermal power in the condenser circuit

In the closed circuit between the condenser and heat exchanger line in the ground, the pump is only to be designed based on these frictional resistances. For reasons of frost protection, it may make sense to use a mixture of glycol and water as the fluid. The material properties are to be adapted to these requirements.

#### Ground collector for cooling and for heat storage

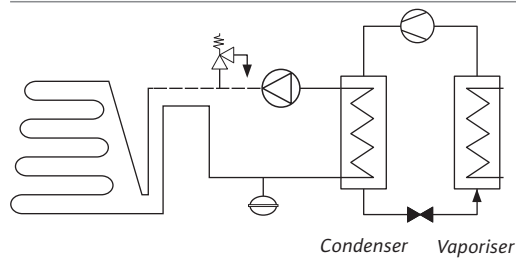

In the closed circuit between the condenser and ground spike, the pump is only to be designed based on these frictional resistances. For reasons of frost protection, it may make sense to use a mixture of glycol and water as the fluid. The material properties are to be adapted to these requirements.

#### Ground spikes for cooling and for heat storage

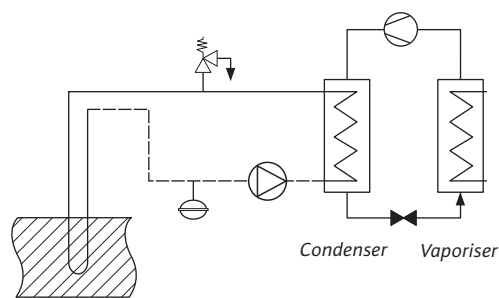

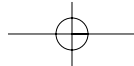
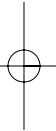
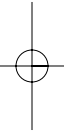
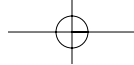



# Generator circuits in the vaporiser part

Independent of the basic hydraulic concept, in most cooling systems, there is the requirement that the water mass flow through the vaporiser may only deviate from the nominal water mass flow by at most 10%. Otherwise, difficulties can be expected in the control of refrigerating machines.

There is also a danger of freezing when the throughput is too low. The demand for a constant vaporiser water flow must be met, then, for all changes caused by the air-conditioning control in the load part. Despite this strict requirement for a constant water volume flow in the vaporiser, in the recent past, refrigerating machines were developed which allow a variable volume flow. Thus, energy-saving speed-controlled pumps can also be used in the primary circuit.

To realise fault-free operation of cold-water networks with several generators and loads, one divides the network into primary and secondary circuits.

## Constant volume flow in the vaporiser circuit

An overflow from the feed to the return of the valve circuit ensures that the volume flow remains constant and that a malfunction in the control of the vaporiser performance is ruled out. The pump is to be dimensioned with respect to the pressure loss on the load which lies in the hydraulically most unfavourable position. On the loads lying in front of it, the water volume is to be throttled to the nominal power. The volume flow of the load is to be guaranteed. It might be necessary to select a higher flow to ensure the minimum volume flow in the vaporiser circuit.

An overflow from the feed to the return of the decoupler circuit ensures that the volume flow remains constant and that a malfunction in the control of the vaporiser performance is ruled out. The pump is to be dimensioned based on the pressure loss in the vaporiser and the resistances over the decoupler. The volume flow of the vaporiser is the required pump flow.

**Vaporiser circuit with constant volume flow by means of a valve circuit**

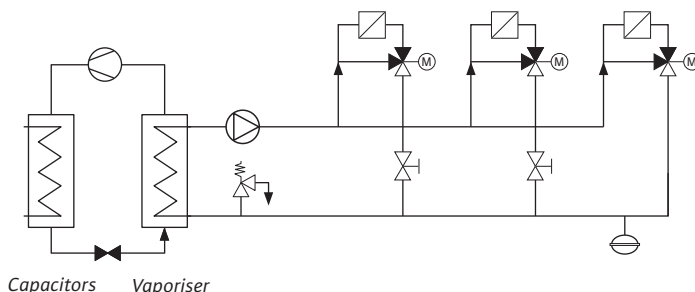

**Vaporiser circuit with constant volume flow by means of hydraulic decouplers**

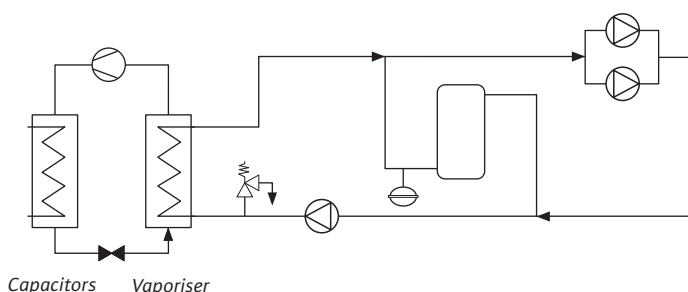

## GENERATOR CIRCUITS IN THE VAPORISER PART

### Variable volume flow in the vaporiser circuit

#### Vaporiser circuit with variable volume flow via a hydraulic decoupler

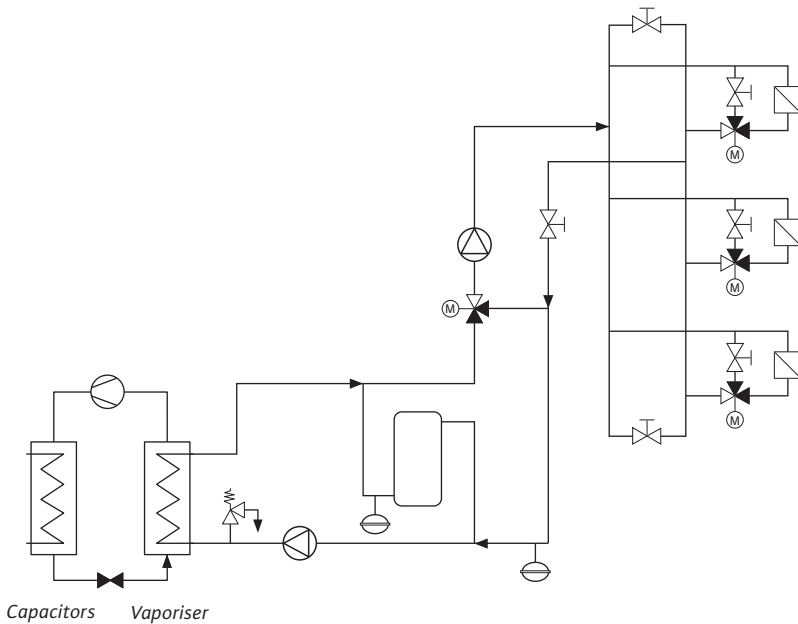

An overflow from the feed to the return of the decoupler circuit ensures that the volume flow remains constant and that a malfunction in the control of the vaporiser performance is ruled out. The pump is to be dimensioned based on the pressure loss in the vaporiser and the resistances over the decoupler. The volume flow for the vaporiser capacity is the required pump flow. To ensure the load capacity, the pipeline for connection to the decoupler might have to be designed larger than what the vaporiser capacity requires. In modern refrigerating machines, the pump capacity can be adapted to the requirements of the load via temperature regulation. The minimum volume flow for the vaporiser is guaranteed by the speed limitation of the pump drive.

In some modern refrigerating machines, the pump capacity can be adapted to the requirements of the load via differential pressure regulation. The minimum volume flow for the vaporiser and/or the pump can be ensured by the overflow part. The overflow volume must be so large that it is guaranteed that the supply line to the load is kept cold. The complete volume flow for the load and the overflow part for the pump capacity must be taken into account. Three-way valves in front of the loads are only required when a longer connection line is necessary. If the connection is near the distribution line, the time until cold fluid is there is usually acceptable.

#### Vaporiser circuit with variable volume flow by means of a valve circuit

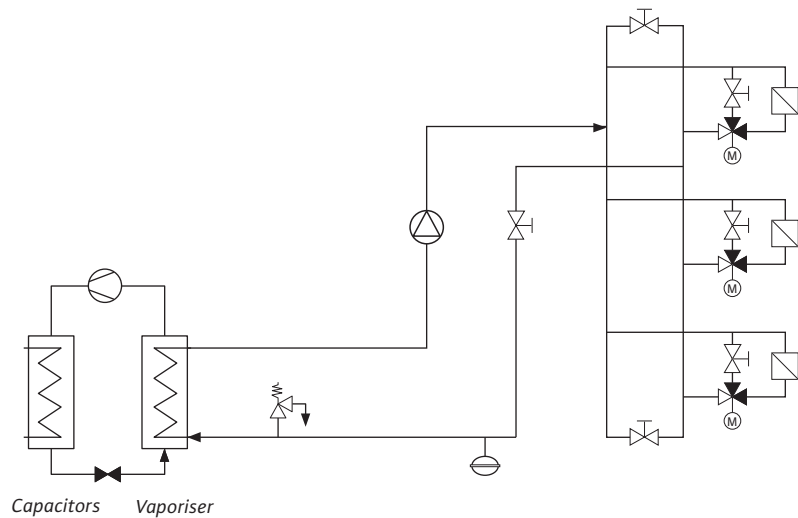

Right now there are only a few possible applications for regulating the pump capacity between zero and the nominal volume. On the one hand, cooling generators are not necessarily suitable for this, and on the other hand, circulation pumps require a minimum volume flow for self-cooling and self-lubrication. More details can be found in the respective catalogues.

#### Vaporiser circuit with variable volume flow over the load

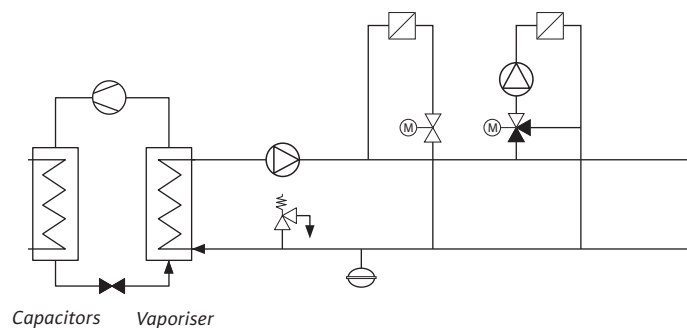

## Cold-water load

There are two main differences in air-conditioning systems for room temperature adjustment. Firstly, the temperature of the air (convection), which is fed to the room, is adjusted; secondly, the room temperature is controlled via radiant heat exchangers, such as cooling ceilings or via component tempering. For hydraulic structures, both systems can have a two-, three- or four-pipe connection.

For cold-water transport, there are always only two pipes. The third and fourth pipes are for the heating part so that the temperature in the room can be maintained for lower outdoor temperatures. In the three-pipe installation, heating and cooling have a common return. Four-pipe connection means that the cooling and heating part are installed separately up to the heat exchanger. Transmission into the room can only occur via a common conductor or by one each for heating or cooling.

In the following figures, only the cooling part is shown with a feed and return.

### Volume flow control

Because the room load is constantly changing and this is also the case for fresh air, the cooling capacity is adjusted by means of changing flow. This circuit is only recommendable when the distribution line is not far away from the load. Usually, all loads may not be connected this way. Not all refrigerating machines or circulating pumps can work without flow. To avoid damage from freezing or dry running, the rerouting or distribution circuit is to be selected, or at the end of the network there is a controlled overflow. It's possible to control the overflow volume by a fixed, throttled bypass or a bypass controller. A bypass controller is optimal when the position of all control valves is monitored, and when a volume limit is fallen short of, an overflow section compensates.

The capacity is adjusted to the room load by changing the flow in the load. In order that only so much flows through the bypass as is needed for temperature maintenance or for maintaining the required minimum volume for the refrigerating machine and/or the pump, a balancing valve is installed in the bypass.

#### Flow rate control with straight-through valve at constant feed temperature

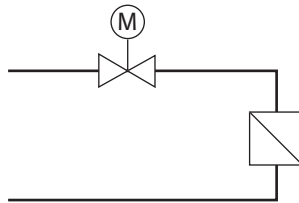

#### Flow rate control with distributor valve at constant feed temperature

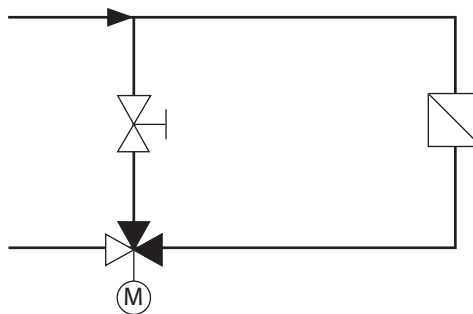

## COLD-WATER LOAD

### Temperature control

Flow rate control is not always favourable. The admix circuit can be used for controlled dehumidification and to prevent falling under the dew point. The feed temperature can be adjusted to the room load and the limits can be kept by measuring the actual value at the critical point of the system. The volume flow in the load circuit remains constant.

#### Temperature control with admix valve

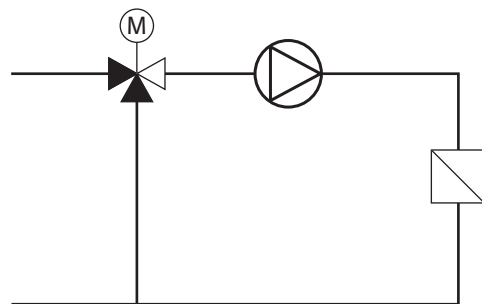

The pump is to be designed according to the capacity and frictional resistances in the load circuit. There should be a differential pressure of zero on the input side of the control loop. This cannot always be achieved in practice, even with controlled feeder pumps. For this reason, a differential pressure controller is to be put in the connection line of the load circuit without auxiliary power. In order to retain good load circuit controllability and to protect the pump from damaging thrust forces, a differential pressure of  $\leq 0.3$  bar is to be maintained.

A distributor valve in the return fulfils the same control function as the admix valve in the feed. The differential pressure controller must always be installed in the same line. This means that in the feed with an admix valve, it is to be installed before the valve, and in the return with a distributor valve, after it. The reason for this installation is the pressurising system in the load circuit – simultaneously closed fittings in the feed and return interrupt these. If zero cooling capacity is set by the valve setting in the load circuit, there is a pressure drop or rise, depending on the change in the fluid temperature by extraneous influences. Therefore, every circulating pump transfers its energy to the fluid and a pressure rise in the load circuit results with a closed connection to the distributor circuit, where the pressure protection is.

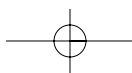
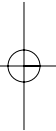
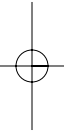
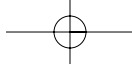

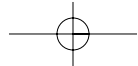
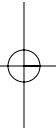
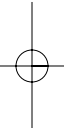
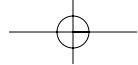

# Observation of constraints for pumps and refrigerating machines

There are physical limits for all technical devices. The refrigerating machines require a volume throughput to prevent icing. If the water volume which is required for the smallest control level of the vaporiser doesn't flow, mechanical damage will result without a safety shutdown.

## Minimum run-time of refrigeration generators and buffer mode

When operating with constant water flow, safe operation is possible when the switch-on/off cycles alternate as seldom as possible. This means that the circulated volume must have such a high storage capacity that the minimum running time of the cooling generator is exceeded. From experience, one knows that 90 % of systems aren't suitable for this without taking additional measures.

### Buffer

The objective is to guarantee economic efficiency and operating safety, long switch-on/off cycles, and therefore to get long running/idle times for the cold-water generator and the hydraulic decoupling from the cold-water generator and consumer system. This is possible with a hydraulic decoupler.

This efficiency is enhanced by nozzle pipes and layering sheets in the tank. The size of the hydraulic decoupler as a buffer is to be determined as follows:

$$S_i = \frac{\text{kW} \cdot F_{tl} \cdot 14.34 \cdot \text{min}}{\Delta tw}$$

### Derivation of the specific factor 14.34

$$\dot{m}_w = \frac{Q_w [\text{kW}] \cdot \frac{\text{KJ}}{\text{s}} \cdot 3600 \frac{\text{s}}{\text{h}}}{C_{pw} 4.2 \frac{\text{KJ}}{\text{kg} \cdot \text{K}} \cdot K [\Delta tw]}$$

$$\dot{m}_w = \frac{\cancel{\text{KJ}} \cdot \text{kg} \cdot \cancel{\text{K}} \cdot 3600 \cancel{\text{s}}}{\cancel{\text{s}} \cdot 4.2 \cancel{\text{KJ}} \cdot \text{h} \cdot \cancel{\text{K}}} = 857 \frac{\text{kg}}{\text{h}} \approx 860 \frac{\text{kg}}{\text{h}}$$

$$\text{Factor} = \left[ \frac{\text{L}}{\text{min}} \right] = \frac{860 \text{ kg} \cancel{\text{h}}}{\cancel{\text{h}} \cdot 60 \text{ min}} = 14.34 \frac{\text{kg}}{\text{min}} = \frac{\text{L}}{\text{min}}$$

When there's a change in the specific heat capacity, the specific factor is also to be redetermined.

### Hydraulic decoupler circuit as buffer

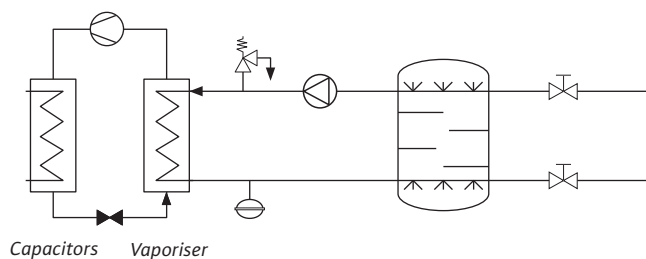

### The minimum system content (Si) depends on

kW	Nominal cooling capacity
F <sub>tl</sub>	Partial load factor for multistage cooling generators
min	Minimum running time
Δtw	Temperature difference
C <sub>pw</sub>	Spec. heat capacity

## PROTECTION OF PUMPS AND REFRIGERATING MACHINES

### Hydraulic connection of ice storage

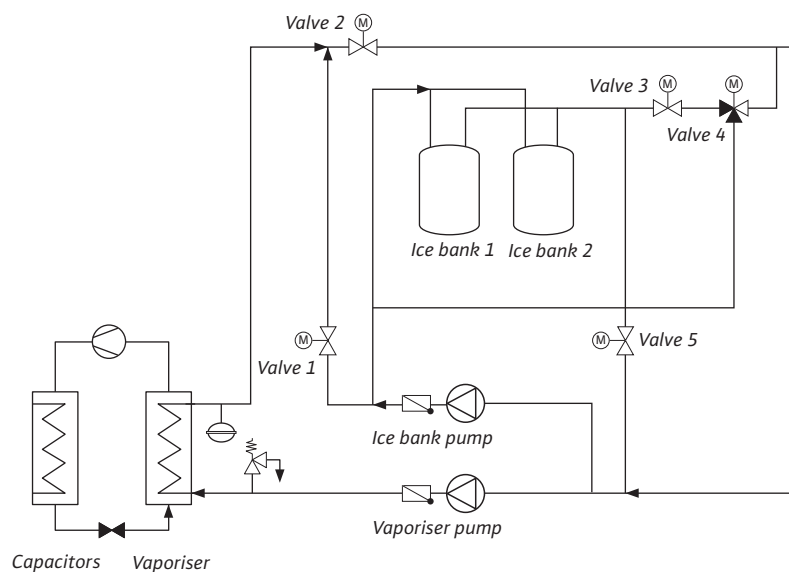

Function table - ice storage operation

Operating mode	Refrigerating machine	Vaporiser pump	Ice storage pump	Valve 1	Valve 2	Valve 3	Valve 4 Gate 1	Valve 4 Gate 2	Valve 4 Gate 3	Valve 5
Discharge ice storage Refrigerating machine on network	Off	Off	On	Closed	Open	Open	Regulating	Regulating	Regulating	Closed
Discharge ice storage Refrigerating machine on network	On	On	Off	Closed	Open	Open	/	/	/	Closed
Charge ice storage	Off	On	Off	Open	Closed	Closed	Closed	Open	Open	Open

### Ice storage

Air-conditioning systems with maintenance-free ice storage systems have been built for the past several years. The refrigerating machine and its connected load, including the recooling capacity, is only dimensioned for the basic load. Load peaks over approx. 50 % of the peak load are covered by the stored ice. Brine serves as a heat carrier. Depending on the system structure, the connection to the house system might be made via a hydraulic decoupler, or by a system insulator (heat exchanger).

The switching states of the valves for the respective load statuses are shown in the table above.

Various flow resistances result from the control with effects on the circulating pumps. When the ice storage is discharged, the ice storage pump must overcome resistances of valves 3 and 4 as well as that of the ice storage. In peak load operation, another resistance of the ice storage pump is only necessary with large volume flow,

since additional flow is forced by the vaporiser circuit, depending on the position of valve 1.

Three different load statuses are given for the vaporiser pump. First the refrigerating machine is alone in the network. Only valve 2 is present as a resistance. If peak load operation is required, the resistances from valves 1, 3 and 4 as well as that of the ice storage are there. If the ice storage is charged, the power losses for valves 1 and 5, as well as for the ice storage, are to be overcome by the vaporiser pump. Based on these requirements, a control of the vaporiser pump over the volume or temperature is recommended at the vaporiser outlet.



## FUSE PROTECTION OF PUMPS AND REFRIGERATING MACHINES

### Protection of the refrigerating machine in the vaporiser circuit

The vaporiser circuit is influenced by its circulating pump. If the pump capacity is too low, the frost protection and/or flow controller switch the refrigerating machine to the malfunction state, i.e. "Off". Before the compressor is switched on, the vaporiser pump must be switched on and have a follow-up time. Circulating pumps require between 2 seconds and a minute to reach the nominal power, depending on the ignition/start circuit.

In the event of a shutdown, the standard circulating pump stops in less than 2 seconds. If a phase is missing in three-phase operation, or if there is undervoltage, the drive can be operated with slippage. The circulating pump runs under its nominal power without a motor protection relay releasing. Due to this, and because the flow volume can be throttled by the system or compressor capacities can be incorrectly controlled, the vaporiser circuit must be equipped with frost protection and flow controllers. Paddle, differential pressure or volume flow switches can be used for flow control. In addition, the vaporiser circuit is to be protected from faulty static and dynamic pressures by a pressurising system and a safety relief valve. In order for the flow volume to be guaranteed during the parallel

operation of several vaporisers with their own circulating pumps, pipework in accordance with Tichelmann or with hydraulic decouplers are recommendable.

#### Safety requirements for operating cooling generators

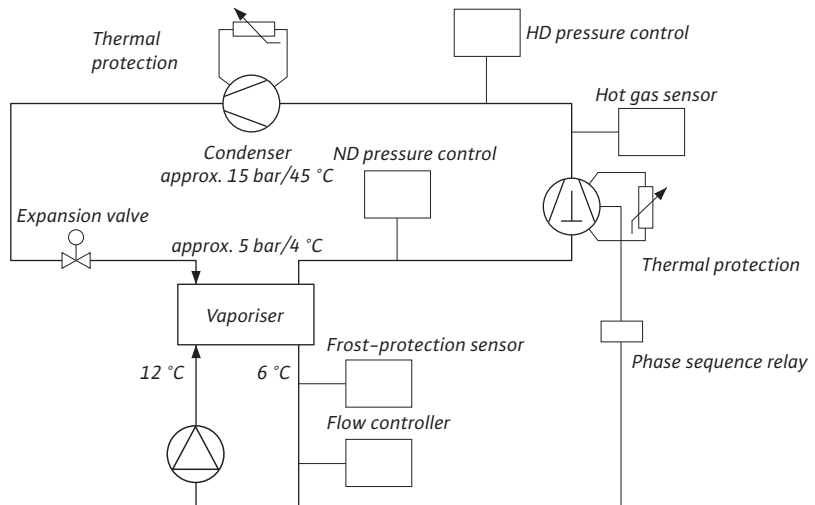

### Protection of the refrigerating machine in the condenser circuit

The setback of the condenser temperature has operational limits. Minimum values are required for the function of the refrigerating machine, especially of the expansion valves, and are to be gotten from the documentation of the respective manufacturer. The temperatures in the condenser depend on the compressor capacity and the inlet and outlet temperatures. The cooling water outlet temperature depends on the circulated volume and the inlet temperature. In the usual case, to protect the refrigerating machine, temperature monitoring at the output of the condenser is sufficient.

Under certain circumstances, further safety measures are required for protecting the recooling system. Thus, to avoid damage, the inlet temperature in sinkholes or floor heating may not exceed a maximum permissible value. Quick-acting valves which can close automatically without current might be necessary for this.

#### Condenser circuit with minimum protection

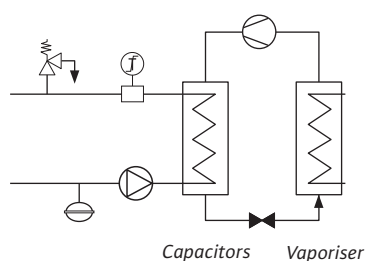

In addition, the condenser circuit is to be protected from faulty static and dynamic pressures by a pressurising system and a safety relief valve. In order for the flow volume to be guaranteed during the parallel operation of several vaporisers with their own circulating pumps, pipework in accordance with Tichelmann or with hydraulic decouplers are recommendable.

## FUSE PROTECTION OF PUMPS AND REFRIGERATING MACHINES

### Protection of circulating pumps

If the constraints are not observed, circulating pumps can be damaged or destroyed by incorrect pressures, fluids, forces, temperatures, circuits, power supplies, vibrations, locations and control-/operating modes.

#### Fluid pressures

The housing and impeller can be damaged or destroyed by cavitation due to excessively low static pressure on the suction side of the circulating pump. The suction connection is also mechanically destroyed if oscillations are also formed in the suction line due to gas formation or air suctioning. This won't happen directly, but becomes apparent after a while, depending on the conditions. In glandless pumps, the bearing lubrication stops and in the case of glanded pumps, the cooling film on the surface of the mechanical seal is missing. This can be avoided by monitoring the inlet pressure with pressure gauges-/or vacuum meters.

An excessively high static pressure can cause the housing to burst or seals to become ineffective. An excessively high contact pressure in mechanical seals can lead to elevated temperatures and premature wear in the seal. The pump can be switched off just to make sure with a maximum pressure controller, or a pressure reducer can be installed in front of the pump.

Excessively high differential pressures between the suction and pressure side of the pump lead to overheating in the pump compartment due to the drive energy, which leads to premature wear in the bearings and seals. Efficient operation is not reachable since the performance in such an operating situation is low. This can be managed by differential pressure control, pump free wheeling valves or with overflow controllers.

The differential pressure between the suction and pressure side of the pump, which lies to the right outside of the documented manufacturer characteristic curve, leads to an overload of the drive and to impermissible forces on the bearing. The lubrication films on the rotating parts which come in contact with the fluid are destroyed. This state can be avoided by means of differential pressure control or volume limiters at the pump.

If, for example, a pump is installed after a hydraulic decoupler as a feeder for a load connected after it, it must be made sure that in the case of a partial load, the residual differential pressure of this pump isn't too high. The load pumps are then started up and too many run. If such an operational situation is to be expected, a differential pressure controller in front of the secondary pump is the solution.

#### Fluid

If the planning of the system was done with water as the heat carrier and if, for whatever reason, brine is filled, the delivery data of the pump no longer applies. All manufacturers specify the flow rate for water in their catalogues. Overall, a density and viscosity of 1 is assumed. Any deviation from this means another flow rate.

Abrasive substances in the fluid lead to premature pump failure. For this reason, water treated in accordance with VDI 2035 or VDTÜV approved fluids should be filled. For details, see the catalogues or offers for the respective types.

If, for example, a system was pressurised with water, emptied and after six weeks was filled up with a commercially available brine, the inhibitors of the brine will dissolve the rust in the lines and will cause premature wear in the rotating parts of the pump. In open systems, the fluid is to be subjected to continuously monitored treatment and suitable materials are to be selected.

If water mixtures are used, the system is to be filled from a premixing tank with the correct mixing ratio. Adding admixtures later will not lead to a sufficient concentration everywhere and energy transport will not be consistent. Also, there is usually an increased danger of corrosion.

## FUSE PROTECTION OF PUMPS AND REFRIGERATING MACHINES

### Forces

Pumps are installed in pipeline systems which produce forces due to temperature expansions or vibrations, which act directly on the connection by the flowing fluid. For safety reasons, pumps are to be integrated in the pipeline system without tension in and loads on the connection. The fixed points for the pipes are to be provided according to the known technical rules.

Fluids in their flowing state exert dynamic forces due to the direction changes caused by bends and fittings. For this reason, pumps should be installed in stabilising sections, diffusers or rectifiers on the suction and pressure side, especially in the case of high flow rates.

### Temperatures

Failing control units make the fluid deviate from the design. As a result, cavitation or excessive volume flows result from excessive fluid temperatures. If the operating temperature of the fluid is lower than planned, the volume flow drops. In both cases, the drive can be overloaded and the motor protection switches the pump off for safety reasons. Since systems today are operated without maintenance personnel constantly there due to cost reasons, it is recommended to monitor the temperatures with alarm equipment.

Ambient pump temperatures act directly on the drive and the housing. The housings can usually accommodate over- and undertemperatures, but only when they don't occur suddenly. The electrodrive can't be operated under 0°C or over 40°C without having a special design. Machine installation rooms are therefore to be well-ventilated or cooled. Direct radiated heat on electromotors is to be prevented.

### Circuits

Motors for star-/delta start-up may not run permanently in the star configuration. 230-volt drives can't handle 400 volts. Voltages which are too low can also lead to electromotor damage. The mains is to be connected appropriately for the drive (see catalogues).

All pumps supply the fluid with energy. This kinetic energy is converted to heat due to the conservation of energy law (nothing is lost). As long as there is a flow, the heat from the pump is transported. When straight-through valves or admixing valves of the loads are closed, the conduction of heat is prevented. Thermal insulation and insulation in accordance with energy-saving regulations act like a thermos flask and the pump compartment heats up.

In practice, especially in the cooling sector, the pressurising system is not designed for temperatures above 110°C, but these can be exceeded in pumps operating at zero flow. Overflow equipment which allows the fluid to cool can help. It makes more sense to switch off the pump by monitoring the closing positions of all control valves. It is possible to shut down by means of a flow signal transmitter. Here, the pump can be intermittently started again with a forced start-up, in order to register the opening of the control valves.

Parallel pump operation in a hydraulic system only works with the same pump capacities unless a differential pressure controller checks the working point and only enables the smaller pump when its pressure capacity has been reached.

Series pump operation in a hydraulic system only works with the same pump capacities unless a volume controller checks the working point and only enables the smaller pump when its volume capacity has been reached.

In a closed system, a pump can convert its complete delivery head into suction. For this reason, the pressurising system must always be on the suction side of the pump, or there must be a control unit in the pump circuit which limits the flow, and therefore reduces the inlet pressure. If this isn't possible due to installation reasons, the configured pressure of the pressurising system must be increased by the maximum delivery head of the pump at zero volume.

## FUSE PROTECTION OF PUMPS AND REFRIGERATING MACHINES

### Power supply

Power supplies from the public mains power supply are subject to certain constraints which are taken into account in the design of drives and control units. Voltage drops can occur due to lines being too long or too thin, which can lead to output deficits and overheating. Control lines and power lines are to be laid separately due to induction processes. Systems are to be protected against overvoltage (e.g. lightning) and to be switched off in the event of undervoltage. Surge arresters and mains monitoring relays with all-pole insulation of the power supply provide solutions.

If self-powered systems, mains replacement operation or converter operation are planned, the following conditions must be met:

- All Wilo pumps are designed to run on European standard voltage 230/400 V ( $\pm 10\%$ ) in accordance with DIN IEC 60038. They have been marked with the CE marking in accordance with the EU machine directive since January 1, 1995. When pumps are utilised in installations with pumping media temperatures above 90°C, a corresponding heat-resistant connection line must be used.

When operating Wilo pumps with control units or module accessories, it is essential to adhere to the electrical operating conditions as set out in VDE 0160. When operating glandless and glanded pumps in conjunction with frequency-converter models not supplied by Wilo, it is necessary to use output filters to reduce motor noise and prevent harmful voltage peaks and to adhere to the following limit values:

- Glandless pumps with  $P_2$  and glanded pumps with  $P_2 \leq 1.1$  kW rate of voltage rise  $du/dt < 500$  V/ $\mu$ s, voltage peaks  $\hat{u} < 650$  V.
- For noise reduction on glandless pump motors, it is recommended that sine filters (LC filters) be used rather than  $du/dt$  filters (RC filters).
- Glanded pumps with  $P_2 > 1.1$  kW rate of voltage rise  $du/dt < 500$  V/ $\mu$ s, voltage peaks  $\hat{u} < 850$  V.

Installations with large cable lengths ( $l > 10$  m) between converter and motor may cause increases of the  $du/dt$  and  $\hat{u}$  levels (resonance). The same may happen for operation with more than 4 motor units at one voltage source. The output filters must be selected as recommended by the converter manufacturer or filter supplier, respectively. The pumps must be operated at a maximum of 95 % of their rated motor speed if the frequency converter causes motor losses. If glandless pumps are operated on a frequency converter, the following limits may not be fallen short of at the connection terminals of the pumps:

$$U_{\min} = 150 \text{ V}, f_{\min} = 30 \text{ Hz}$$

The service life and operational reliability of a circulating pump depend to a great extent on the choice of the correct motor protection device. Motor protection switches are unsuitable for utilisation in conjunction with multi-speed pumps due to their different nominal current ratings at different speed settings which require correspondingly different fuse protection.

All glandless circulating pumps are either

- blocking-current proof
- provided with internal protection against unacceptably high winding temperatures
- provided with full motor protection through thermal winding contact and separate relay
- provided with full motor protection and built-in trip mechanism (for series, see catalogue data).
- No further motor protection by the customer is required except where this is stipulated for blocking current-proof motors and motors with internal protection against unacceptably high winding temperatures by the energy supply company.

Standard glanded pumps are to be protected by onsite motor protection switches with a nominal current setting. Full motor protection is only achieved, however, when a thermal winding contact or a PTC thermistor detector is additionally monitored.

If the glanded pump is equipped with a control mounted to the motor housing, it is equipped with full motor protection from the manufacturer.

The protective measure of protective grounding is to be used for frequency converter controllers with three-phase current connections. Residual current protective equipment in accordance with DIN VDE 0664 is not permitted. Exception: Selective universal-current-sensitive residual current circuit breaker (recommended nominal residual current  $\Delta = 300$  mA).

Maximum back-up fuses are to be provided according to the onsite installation and the installed devices in accordance with DIN/VDE. The maximum permissible cable/wire cross-section is to be taken from the catalogues. The ambient operating conditions are to be taken into consideration in selecting the cables. Special conditions, such as water-pressure tightness or shields, etc. might be required.

## FUSE PROTECTION OF PUMPS AND REFRIGERATING MACHINES

### Vibrations

Every circulating machine and every flowing fluid generates vibrations. All Wilo pumps are low-vibration versions. As a result of the system, resonance can occur, and vibrations are amplified. For this reason, please observe the following.

Pipelines and pumps should be installed in a stress-free condition. The pipelines must be fixed in such a way that the pump is not supporting the weight of the pipeline. In-line pumps are designed for direct horizontal and vertical installation in a pipeline. From a motor power of 18.5 kW it is not permissible to install the pump with the pump shaft in a horizontal attitude. On a vertically mounted pump the pipeline must be stress-free and the pump must be supported on the pump feet. To suppress vibration amplification, installation on a base is recommended. Monobloc or standard pumps are to be mounted on concrete foundations or mounting brackets.

Correct selection of the pump base version is one of the factors of decisive importance for low-noise operation of the pumps. A direct and rigid connection between the pump unit and the base block is recommended for the purpose of increasing the mass capable of absorbing vibration and for compensating of uncompensated gravitational forces. Vibration-isolated installation does however require at the same time an elastic intermediate layer for separating the fundament block itself from the solidium.

The type and the material of the intermediate layer to be selected depends on a variety of different factors (and areas of responsibility), including among others rotational speed, aggregate mass and centre of gravity, constructional design (architect) and the development of other influences caused by pipe lines, etc. (planners/installation company).

It is recommended – taking into account all structurally and acoustically relevant criteria – that a qualified building acoustics specialist be given the task of configuration and design where necessary.

The external dimensions of the base block should be about 15 to 20 cm longer in the length and width than the external dimensions of the pump unit. Care should be taken to ensure that the design of the base pedestal that no acoustic bridges are formed by plaster, tile or auxiliary constructions that would nullify or sharply reduce the sound insulation effect.

Planners/and installation companies must take care to ensure that the pipe connections to the pump are completely stress-free in their design and unable to exercise any gravitational or vibrational influences on the pump housing whatsoever.

Fixed points with no connection to the base are recommended for the pipe connections on the suction and pressure sides of the pump.

*Please also observe the chapter "Pump as a noise generator".*

## FUSE PROTECTION OF PUMPS AND REFRIGERATING MACHINES

### Sites

The standard pumps must be protected from the weather and installed in a dry frost -/dust-free, well-ventilated and non-explosive atmosphere. In the case of outdoor installations, special motors and special corrosion protection are required.

The installation of standard pumps with the motor and terminal box facing downwards is not permissible. Free space (at least about 1.2 m without space requirement for material on two sides) is to be provided for dismantling the motor, lantern and impeller. For a nominal motor power greater than 4 kW, a suitable tackle support for installation and maintenance work is recommended. If the pumps are installed higher than 1.8 m off the ground, there should be onsite working platforms which are permanently installed or which can be set-up any time in mobile form.

Borehole and submersible pumps are to have a permanent minimum and maximum water coverage, according to their specifications. There should always be sufficient room for lowering and pulling up the pumps and their pipework. In the case of sump installations, intermediate platforms for installation and maintenance work must always be available according to the valid accident prevention regulations.

To test the pump capacity, an inlet and outlet section is to be provided in front of and behind the pump during pipe installation.

The minimum dimension for the measuring point  $A_d$  and  $A_s$  is 2 times the pipe diameter, for  $U_s$   $5+Nq/53$  and for  $U_d$  2.5. It is recommended to install pressure gauges with a test cock.

All rated power data and operating values apply at a rated frequency of 50 Hz, a rated voltage of 230 /400 V to 3 kW or 400/ 690 V starting at 4 kW, a maximum coolant temperature (KT - air temperature) of max. 40°C and an installation altitude of up to 1000 m above mean sea level. For cases outside of these parameters a power rating reduction must be applied or a larger motor or a higher insulation class must be selected.

### Minimum distances of the measuring points for checking the pump pressure

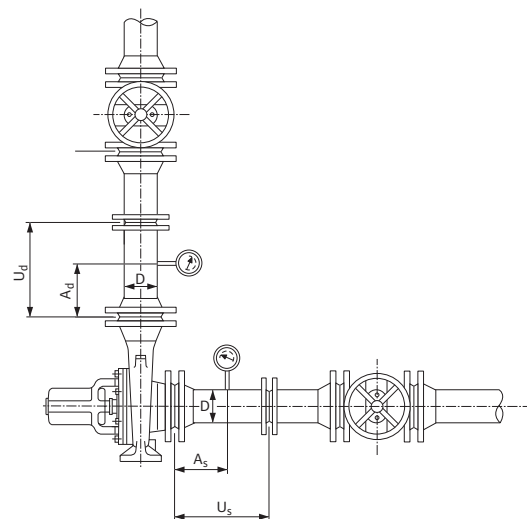

### Type of control

Pumps which serve as admission pressure pumps are only to be switched on/off when the volume decrease through the secondary pump circuit lies at the required minimum/maximum flow volume. When several admission pressure pumps are operating in parallel, an automatic switch-on/off of the individual pumps within their permitted working ranges is required.

Circulating pumps in secondary circuits are only to be switched on when the primary circuit is delivering the required minimum volume. They are to be switched off when the admission pressure pump provides so much pressure that the volume flow is too high.

If there is an on-site, stepless speed control, the minimum and maximum speed are to be limited so that there is no overloading and the motor self-cooling function is guaranteed. Throttle and bypass controllers in the pump circuit are to be configured so that the maximum and minimum permitted volume flows are always guaranteed. It makes sense to monitor the fluid temperature with an automatic limit shut-down function on the pump.

The parallel operation of pumps and the simultaneous stepless control of one, several or all pumps is only possible with a load-sensitive, automatic switch-on/off or cut-in function within the permissible limits of the flow and delivery head of the individual aggregates.

In order to avoid malfunctions and damage, the admission pressure/pressurising system is to be monitored. Because of the constantly changing pressures in controlled pump circuits, a different feed flow is always possible.

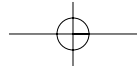
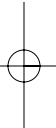
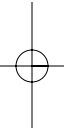
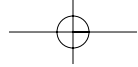



# Examples for the pump selection in the condenser circuit

## Well system

To conduct heat away from the condenser, a well system has been selected. The brine for the suction well lies 10 m under the floor of the installation room for the refrigerating machine. Due to the geodetic head difference, a submersible pump system was selected. A pipeline length of 30 m results between the submersible pump and the connection to the refrigerating machine. The suction side of the condenser lies 2 m under the highest point of the pipeline to the sinkhole and has a total pipe length of 45 m. The heat capacity is 200 kW and should be conducted away into the well system with a temperature difference of 6 K. The circulated volume is determined as follows:

### Formula for volume flow $V_{PU}$

$$V_{PU} = \frac{\dot{Q}_N}{1.16 \cdot \Delta\vartheta} \text{ m}^3/\text{h}$$

### Calculation

$$V_{PU} = \frac{200}{1.16 \cdot 6} \text{ m}^3/\text{h}$$

$$V_{PU} = 28.74 \text{ m}^3/\text{h}$$

The desired pump head results from the pipeline requirements. The total altitude difference is 12 m. The pipeline material is PVC in a nominal diameter of 100. The R value is 100 Pa/m at a flow rate of about 1 m/s. Based on the installed fittings, bends and the condenser resistance, the addition of 8 bends, a suction valve and 2 shut-off valves results in a value of 114.13.

### Formula for the pressure / the delivery head H

$$H_{Ges} = H_{geo} + H_A$$

$$H_A = H_{VL} + H_{VA}$$

### Calculation

$$H_{Ges} = H_{geo} + H_{VL} + H_{VA}$$

$$H_{VL} = R \cdot l$$

$$H_{VA} = Z$$

$$H_{VL} = 100 \cdot 75$$

$$H_{VL} = 7\,500 \text{ Pa}$$

$$Z = \sum \zeta \frac{\rho \cdot w^2}{2} \text{ Pa}$$

$$Z = 114.13 \cdot \frac{999.6 \cdot 1^2}{2} \text{ Pa}$$

$$Z = 57\,127 \text{ Pa}$$

### Result

$$H_{Ges} = H_{geo} + H_{VL} + H_{VA}$$

$$H_{Ges} = 120\,000 \text{ Pa} + 7\,500 \text{ Pa} + 57\,127 \text{ Pa}$$

$$H_{Ges} = 184\,627 \text{ Pa}$$

Abbreviation	Description
1.16	Spec. heat capacity [Wh/kgK]
$\Delta\vartheta$	Dimensioned temperature difference
[K]	10–20 K for standard systems
$\dot{Q}_N$	Heat demand [kW]
$H_A$	Pressure loss of the system in Pa
$H_{geo}$	Geodetic pressure head difference in Pa (1 m WS ~ 10 000 Pa)
$H_{Ges}$	Total pressure loss in Pa
$H_{VL}$	Pipeline pressure loss in Pa
$H_{VA}$	Fitting pressure loss in Pa
R	Pipe friction resistance in Pa/m
L	Pipe length
$\zeta$	Resistance values in Pa
$\rho$	Density of fluid in kg/m <sup>3</sup>
$w^2$	Flow rate in m/s <sup>2</sup>
Z	Pressure loss in fittings in Pa
$\Sigma$	Total losses

## EXAMPLES FOR THE PUMP SELECTION IN THE CONDENSER CIRCUIT

A submersible pump with a flow rate of  $Q = 28.74 \text{ m}^3/\text{h}$  and  $H = 18.5 \text{ m}$  is to be selected.

The selected pump is the Wilo-Sub TWU 6-2403 with cooling jacket.

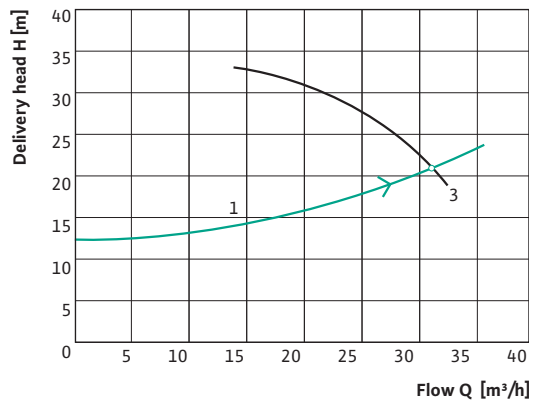

### Operating data specifications

Flow	28.74 m <sup>3</sup> /h
Delivery head	18.5 m
Pumped fluid	Water
Fluid temperature	10 °C
Density	0.9996 kg/dm <sup>3</sup>
Kinematic viscosity	1.31 mm <sup>2</sup> /s
Vapor pressure	0.1 bar

### Hydraulic data (duty point)

Flow	31.3 m <sup>3</sup> /h
Delivery head	20.3 m

## EXAMPLES FOR THE PUMP SELECTION IN THE CONDENSER CIRCUIT

### Open cooling tower system

The condenser circuit is cooled via an open cooling tower. At the same capacity of 200 kW and a temperature difference of 5 K, the following volume flow results:

#### Formula for volume flow $\dot{V}$

$$\dot{V}_{PU} = \frac{\dot{Q}_N}{1.16 \cdot \Delta\vartheta} \text{ m}^3/\text{h}$$

$$\dot{V}_{PU} = \frac{200}{1.16 \cdot 5} \text{ m}^3/\text{h}$$

$$\dot{V}_{PU} = \mathbf{34.48 \text{ m}^3/\text{h}}$$

For the pressure loss calculation, a pipe length of 88 m is given with 14 bends, 4 stop valves and an altitude difference of 2.2 m between the minimum water level and nozzle fitting. PVC pipework is selected with a nominal diameter of 80. This results in a resistance coefficient of  $\zeta = 59.7$ . The result is:

#### Formula for the pressure /the delivery head H

$$H_{Ges} = H_{geo} + H_A$$

$$H_A = H_{VL} + H_{VA}$$

#### Calculation

$$H_{Ges} = H_{geo} + H_{VL} + H_{VA}$$

$$H_{VL} = R \cdot l$$

$$H_{VA} = Z$$

$$H_{VL} = 400 \cdot 88$$

$$H_{VL} = 35\,200 \text{ Pa}$$

$$Z = \sum \zeta \frac{\rho \cdot w^2}{2} \text{ Pa}$$

$$Z = 59.7 \cdot \frac{999.6 \cdot 1.9^2}{2} \text{ Pa}$$

$$Z = 107\,230 \text{ Pa}$$

#### Result

$$H_{Ges} = H_{geo} + H_{VL} + H_{VA}$$

$$H_{Ges} = 22\,000 \text{ Pa} + 35\,200 \text{ Pa} + 107\,230 \text{ Pa}$$

$$H_{Ges} = \mathbf{164\,430 \text{ Pa}}$$

A monobloc pump with a flow rate of  $Q = 34.48 \text{ m}^3/\text{h}$  and  $H = 16.5 \text{ m}$  is to be selected.

#### Abbreviation Description

1.16	Spec. heat capacity [Wh/kgK]
$\Delta\vartheta$	Dimensioned temperature difference
[K]	10–20 K for standard systems
$\dot{Q}_N$	Heat demand [kW]
$H_A$	Pressure loss of the system in Pa
$H_{geo}$	Geodetic pressure head difference in Pa (1 m WS ~ 10 000 Pa)
$H_{Ges}$	Total pressure loss in Pa
$H_{VL}$	Pipeline pressure loss in Pa
$H_{VA}$	Fitting pressure loss in Pa
R	Pipe friction resistance in Pa/m
l	Pipe length
$\zeta$	Resistance values in Pa
$\rho$	Density of fluid in kg/m <sup>3</sup>
$w^2$	Flow rate in m/s <sup>2</sup>
Z	Pressure loss in fittings in Pa
$\Sigma$	Total losses

## EXAMPLES FOR THE PUMP SELECTION IN THE CONDENSER CIRCUIT

The selected pump is the Wilo-CronoBloc-BL 40/130-3/2 with red brass impeller.

Cavitation can be ruled out since the water level in the cooling tower is about 12 m above the pump inlet. The fluid must constantly be salted and treated due to the corrosion and legionella problem.

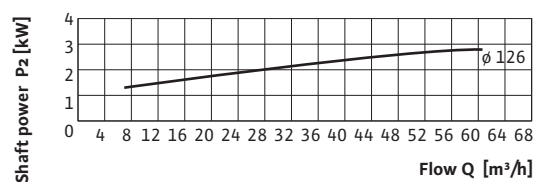
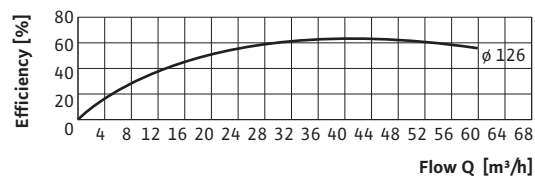
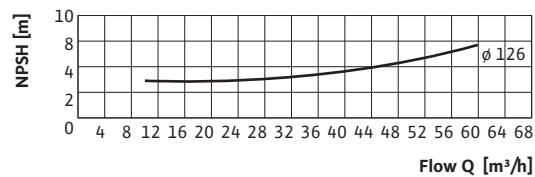
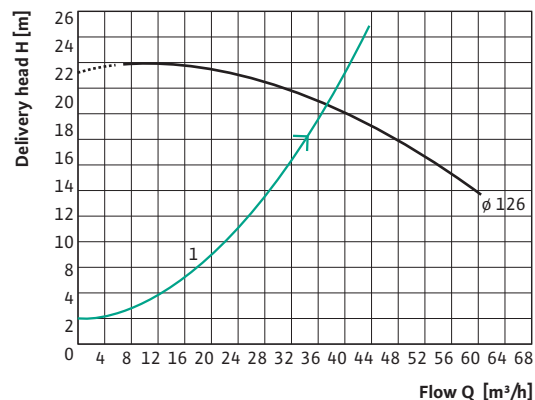

### Operating data specifications

Flow	34.48 m <sup>3</sup> /h
Delivery head	16.5 m
Pumped fluid	Water
Fluid temperature	32 °C
Density	0.9951 kg/dm <sup>3</sup>
Kinematic viscosity	0.7605 mm <sup>2</sup> /s
Vapor pressure	0.1 bar

### Hydraulic data (duty point)

Flow	37.3 m <sup>3</sup> /h
Delivery head	19 m
Shaft power P2	2.51 kW
Speed	2000 rpm
NPSH	3.43 m
Impeller diameter	125 mm

## EXAMPLES FOR THE PUMP SELECTION IN THE CONDENSER CIRCUIT

### Closed cooling tower system

Based on its being winter-proof, the capacity of 200 kW is recooled via a closed cooling tower. Antifrogen L having a concentration of 40 % to 60 % water is filled for frost protection.

#### Formula for volume flow $\dot{V}$

$$\dot{V}_{PU} = \frac{\dot{Q}_N}{1.04 \cdot \Delta\vartheta} \text{ m}^3/\text{h}$$

#### Calculation

$$\dot{V}_{PU} = \frac{200}{1.04 \cdot 5} \text{ m}^3/\text{h}$$

$$\dot{V}_{PU} = \mathbf{38.46 \text{ m}^3/\text{h}}$$

A pipe length of 88 m is given for calculating the pressure loss, with 14 bends and 4 stop valves. PVC pipework is selected with a nominal diameter of 80. This results in a resistance coefficient of = 59.7. The result is:

#### Formula for the pressure /the delivery head H

$$H_{Ges} = (H_{geo} + H_A) \cdot f_p \quad H_A = H_{VL} + H_{VA}$$

#### Calculation

$$H_{Ges} = (H_{geo} + H_{VL} + H_{VA}) \cdot f_p$$

$$H_{VL} = R \cdot l$$

$$H_{VL} = 400 \cdot 88$$

$$H_{VL} = 35\,200 \text{ Pa}$$

$$H_{VA} = Z$$

$$Z = \sum \zeta \cdot \frac{\rho \cdot w^2}{2} \text{ Pa}$$

$$Z = 59.7 \cdot \frac{1\,034 \cdot 1.9^2}{2} \text{ Pa}$$

$$Z = 111\,422 \text{ Pa}$$

#### Result

$$H_{Ges} = (H_{geo} + H_{VL} + H_{VA}) \cdot f_p$$

$$H_{Ges} = (0 + 35\,200 \text{ Pa} + 111\,422 \text{ Pa}) \cdot 1.36$$

$$H_{Ges} = \mathbf{199\,406 \text{ Pa}}$$

A monobloc pump with a flow rate of  $Q = 38.46 \text{ m}^3/\text{h}$  and  $H = 19.9 \text{ m}$  is selected.

## EXAMPLES FOR THE PUMP SELECTION IN THE CONDENSER CIRCUIT

The selected pump is the Wilo-CronoBloc-BL 40/140-4/2.

Cavitation can be ruled out since this is a closed circuit. The diaphragm extension vessel is to be determined for a volume expansion of 2 to 5 %.

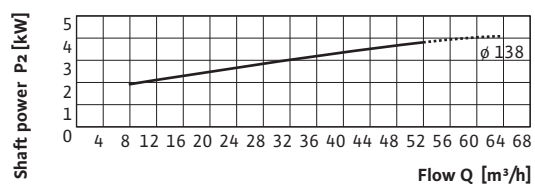
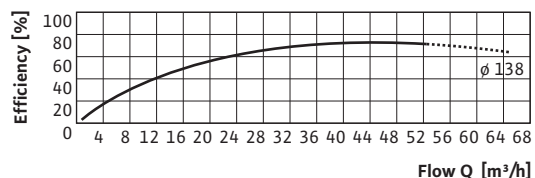
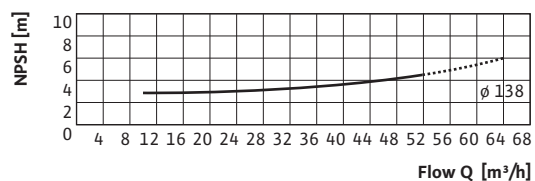
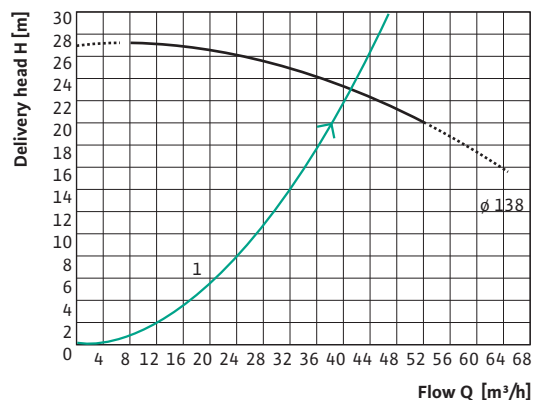

### Operating data specifications

Flow	38.46 m <sup>3</sup> /h
Delivery head	19.9 m
Pumped fluid	Antifrogen L (40 %)
Fluid temperature	27 °C
Density	1.039 kg/dm <sup>3</sup>
Kinematic viscosity	5.963 mm <sup>2</sup> /s
Vapor pressure	0.1 bar

### Hydraulic data (duty point)

Flow	41.3 m <sup>3</sup> /h
Delivery head	23.1 m
Shaft power P2	2.57 kW
Speed	2000 rpm
NPSH	3.67 m
Impeller diameter	138 mm

## EXAMPLES FOR THE PUMP SELECTION IN THE CONDENSER CIRCUIT

### Heat recovery via building heating and hot water production

In the case of heat recovery, the flow rate can be determined with a larger temperature difference. A difference of 20 K is reasonable. At the same capacity of 200 kW and a temperature difference of 20 K, the following volume flow results:

#### Formula for volume flow $\dot{V}$

$$\dot{V}_{PU} = \frac{\dot{Q}_N}{1.16 \cdot \Delta\vartheta} \text{ m}^3/\text{h}$$

#### Calculation

$$\dot{V}_{PU} = \frac{200}{1.16 \cdot 20} \text{ m}^3/\text{h}$$

$$\dot{V}_{PU} = \mathbf{8.62 \text{ m}^3/\text{h}}$$

Steel pipework is selected with a pipe length of 36 m with a nominal diameter of 50, with 8 bends and 4 flat slide valves. This results in a resistance coefficient of  $\Sigma\zeta = 74.9$ . The result is:

#### Formula for the pressure /the delivery head H

$$H_{Ges} = H_{geo} + H_A \qquad H_A = H_{VL} + H_{VA}$$

#### Calculation

$$H_{Ges} = H_{geo} + H_{VL} + H_{VA}$$

$$H_{VL} = R \cdot l$$

$$H_{VL} = 160 \cdot 36$$

$$H_{VL} = 5\,760 \text{ Pa}$$

$$H_{VA} = Z$$

$$Z = \Sigma\zeta \cdot \frac{\rho \cdot w^2}{2} \text{ Pa}$$

$$Z = 74.9 \cdot \frac{977.7 \cdot 0.98^2}{2} \text{ Pa}$$

$$Z = 35\,165 \text{ Pa}$$

#### Result

$$H_{Ges} = H_{geo} + H_{VL} + H_{VA}$$

$$H_{Ges} = 0 + 5\,760 \text{ Pa} + 35\,165 \text{ Pa}$$

$$H_{Ges} = \mathbf{40\,925 \text{ Pa}}$$

To minimise maintenance costs, a glandless pump with a flow rate of  $Q = 8.62 \text{ m}^3/\text{h}$  and  $H = 4.09 \text{ m}$  is selected.

#### Abbreviation Description

1.16	Spec. heat capacity [Wh/kgK]
$\Delta\vartheta$	Dimensioned temperature difference
[K]	10–20 K for standard systems
$\dot{Q}_N$	Heat demand [kW]
$H_A$	Pressure loss of the system in Pa
$H_{geo}$	Geodetic pressure head difference in Pa (1 m WS ~ 10 000 Pa)
$H_{Ges}$	Total pressure loss in Pa
$H_{VL}$	Pipeline pressure loss in Pa
$H_{VA}$	Fitting pressure loss in Pa
R	Pipe friction resistance in Pa/m
L	Pipe length
$\zeta$	Resistance values in Pa
$\rho$	Density of fluid in kg/m <sup>3</sup>
$w^2$	Flow rate in m/s <sup>2</sup>
Z	Pressure loss in fittings in Pa
$\Sigma$	Total losses

## EXAMPLES FOR THE PUMP SELECTION IN THE CONDENSER CIRCUIT

The selected pump is the Wilo-TOP-S 50/4 3-PN 6/10.

Cavitation can be ruled out since this is a closed circuit. For protection, the condenser circuit should have its own safety valve and be equipped with its own diaphragm extension vessel for a volume expansion of 2 to 5 %.

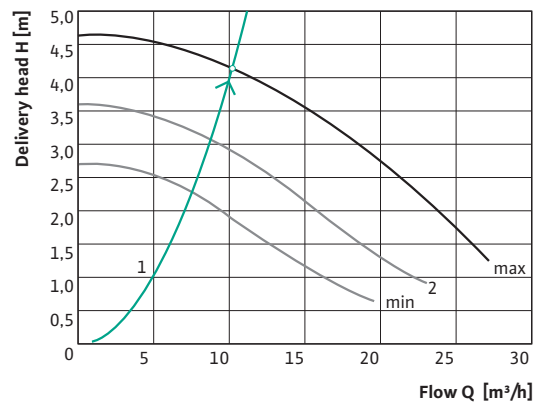

### Note!

The pump must constantly circulate the required water volume when the refrigerating machine is in operation. This is to be ensured by a hydraulic switch, heat exchanger, differential pressure valves or bypasses.

The necessary cooling towers are to be designed with their own pump, as described before. When antifreeze is added, system separation with heat exchangers is recommended.

### Operating data specifications

Flow	8.62 m³/h
Delivery head	4.09 m
Pumped fluid	Water
Fluid temperature	70 °C
Density	0.9777 kg/dm³
Kinematic viscosity	0.4084 mm²/s
Vapor pressure	0.3121 bar

### Hydraulic data (duty point)

Flow	8.88 m³/h
Delivery head	4.3 m
Power consumption P1	0.295 kW
Speed	2600 rpm



## EXAMPLES FOR THE PUMP SELECTION IN THE CONDENSER CIRCUIT

### Ground collector system

To protect against freezing, the system is filled with a glycol mixture (40% Antifrogen N + 60% water). The circulated volume is determined as follows:

#### Formula for volume flow $V$

$$V_{PU} = \frac{\dot{Q}_N}{0.97 \cdot \Delta\vartheta} \text{ m}^3/\text{h}$$

#### Calculation

$$V_{PU} = \frac{200}{0.97 \cdot 6} \text{ m}^3/\text{h}$$

$$V_{PU} = \mathbf{34.29 \text{ m}^3/\text{h}}$$

The desired pump head results from the pipeline requirements. PVC pipeline material is selected with a nominal diameter of 125. The R value is 50 Pa/m at a flow rate of about 0.8 m/s. Based on the installed fittings, bends and the condenser resistance, the addition of 8 bends and 2 shut-off valves results in a value of 109.63. Another 20 kPa are to be included in the calculation for the collector and the pipe length to be considered is 75 m.

#### Formula for the pressure /the delivery head H

$$H_{Ges} = (H_{geo} + H_A) \cdot f_p \quad H_A = H_{VL} + H_{VA}$$

#### Calculation

$$H_{Ges} = (H_{geo} + H_{VL} + H_{VA}) \cdot f_p$$

$$H_{VL} = R \cdot l$$

$$H_{VL} = 50 \cdot 75$$

$$H_{VL} = 3\,750 \text{ Pa}$$

$$H_{VA} = Z + \text{collector resistance}$$

$$Z = \Sigma \zeta \cdot \frac{\rho \cdot w^2}{2} \text{ Pa}$$

$$Z = 109.63 \cdot \frac{1\,070 \cdot 0.8^2}{2} \text{ Pa}$$

$$Z = 37\,537 \text{ Pa}$$

#### Result

$$H_{Ges} = (H_{geo} + H_{VL} + H_{VA}) \cdot f_p$$

$$H_{Ges} = (0 + 3\,750 \text{ Pa} + 37\,537 \text{ Pa}) \cdot 1.47$$

$$H_{Ges} = \mathbf{90\,092 \text{ Pa}}$$

A pump with a flow rate of  $Q = 34.29 \text{ m}^3/\text{h}$  and  $H = 9.0 \text{ m}$  is to be selected.

Abbreviation	Description
1.16	Spec. heat capacity [Wh/kgK]
$\Delta\vartheta$	Dimensioned temperature difference
[K]	10-20 K for standard systems
$\dot{Q}_N$	Heat demand [kW]
$H_A$	Pressure loss of the system in Pa
$H_{geo}$	Geodetic pressure head difference in Pa (1 m WS ~ 10 000 Pa)
$H_{Ges}$	Total pressure loss in Pa
$H_{VL}$	Pipeline pressure loss in Pa
$H_{VA}$	Fitting pressure loss in Pa
R	Pipe friction resistance in Pa/m
L	Pipe length
$\zeta$	Resistance values in Pa
$\rho$	Density of fluid in kg/m <sup>3</sup>
$w^2$	Flow rate in m/s <sup>2</sup>
Z	Pressure loss in fittings in Pa
$\Sigma$	Total losses

## EXAMPLES FOR THE PUMP SELECTION IN THE CONDENSER CIRCUIT

The selected pump is the Wilo-CronoLine-IL 65/170-1.5/4.

Cavitation can be ruled out since this is a closed circuit. For protection, the condenser circuit should have its own safety valve and be equipped with its own diaphragm extension vessel for a volume expansion of 5 to 7 %.

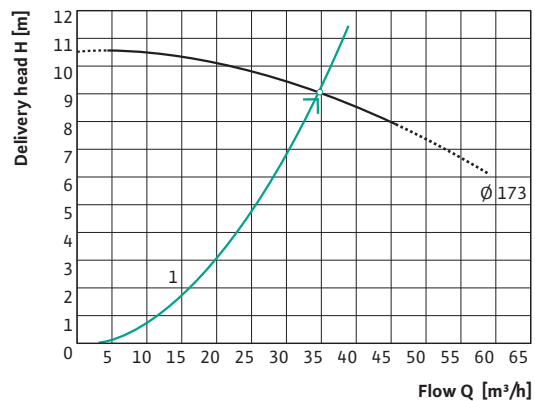

### Operating data specifications

Flow	34.29 m³/h
Delivery head	9 m
Pumped fluid	Antifrogen N (40%)
Fluid temperature	10 °C
Density	1.073 kg/dm³
Kinematic viscosity	4.507 mm²/s
Vapor pressure	0.1 bar

### Hydraulic data (duty point)

Flow	34.7 m³/h
Delivery head	9.22 m
Shaft power P2	1.31 kW
Speed	1450 rpm
NPSH	2.39 m
Impeller diameter	173 mm

## EXAMPLES FOR THE PUMP SELECTION IN THE CONDENSER CIRCUIT

### Ground spike system

The closed circuit of a ground spike system is specified with a pressure loss of 3.1 m. The pressure for the condenser (2 m) is to be added. The pump must achieve a delivery head of at least 5.1 m.

To protect against freezing, the system is filled with a glycol mixture (40 % Tyfocor L and 60 % water). The circulated volume is determined as follows:

#### Formula for volume flow $\dot{V}$

$$V_{PU} = \frac{\dot{Q}_N}{1.01 \cdot \Delta\vartheta} \text{ m}^3/\text{h}$$

#### Calculation

$$V_{PU} = \frac{200}{1.01 \cdot 4} \text{ m}^3/\text{h}$$

$$V_{PU} = 49.32 \text{ m}^3/\text{h}$$

A pump with a flow rate of  $Q = 49.32 \text{ m}^3/\text{h}$  and  $H = 5.1 \text{ m}$  is to be selected.

#### Abbreviation Description

0.97	Spec. heat capacity [Wh/kgK]
$\Delta\vartheta$	Dimensioned temperature difference
[K]	2-6 K for standard systems
$Q_N$	Heat demand [kW]

The selected pump is the Wilo-CronoBloc-BL 80/150-1.5/4.

Cavitation can be ruled out since this is a closed circuit. For protection, the condenser circuit should have its own safety valve and be equipped with its own diaphragm extension vessel for a volume expansion of 5 to 7 %.

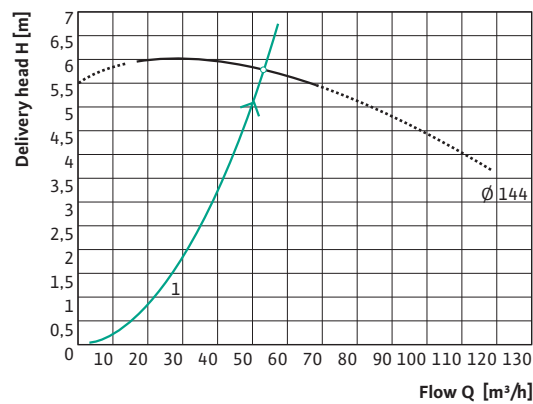

#### Operating data specifications

Flow	49.32 m <sup>3</sup> /h
Delivery head	5.1 m
Pumped fluid	Tyfocor L (40%)
Fluid temperature	10 °C
Density	1.045 kg/dm <sup>3</sup>
Kinematic viscosity	6.604 mm <sup>2</sup> /s
Vapor pressure	0.1 bar

#### Hydraulic data (duty point)

Flow	52.6 m <sup>3</sup> /h
Delivery head	5.78 m
Shaft power P <sub>2</sub>	1.41 kW
Speed	1450 rpm
NPSH	2.54 m
Impeller diameter	144 mm

# Examples for the pump selection in the cold water circuit

## Flow rate control with straight-through valves

### Flow rate control with straight-through valves and pump performance adjustment

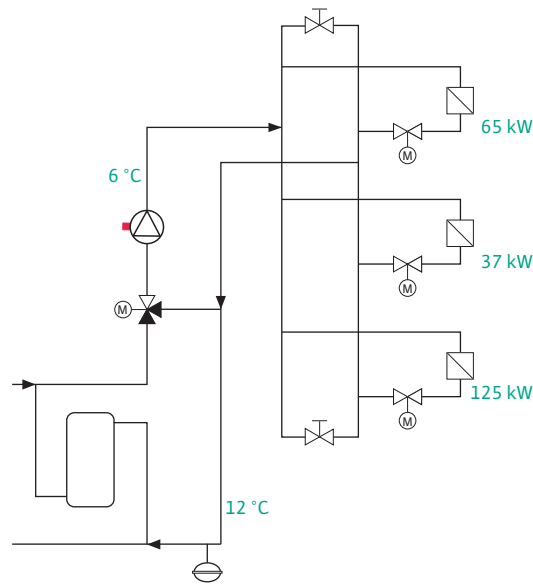

The pressure loss of the system (4.65 m) is taken as the maximum pump head from a pipework calculation. Due to the main pressure loss of 3 m in the individual load circuit, a pump which has constant pressure regulation is to be selected.

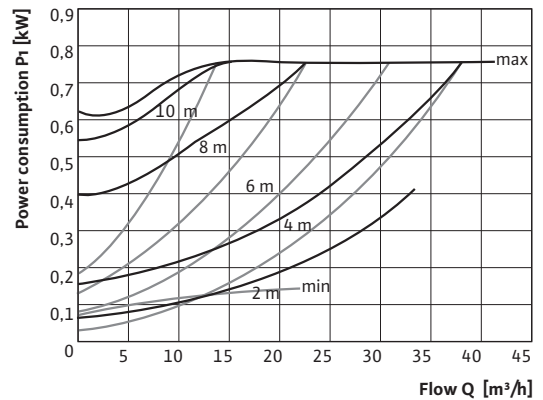
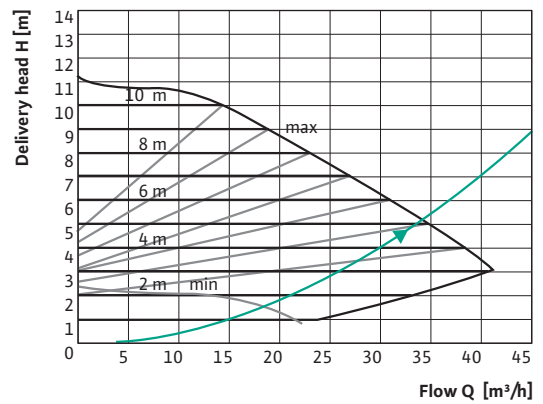

The flow is determined as follows:

### Formula for volume flow $\dot{V}_{PU}$

$$\dot{V}_{PU} = \frac{\dot{Q}_N}{1.16 \cdot \Delta\vartheta} \text{ m}^3/\text{h}$$

#### Abbreviation Description

1.16	Spec. heat capacity [Wh/kgK]
$\Delta\vartheta$	Dimensioned temperature difference [K]
10–20 K	for standard systems
$\dot{Q}_N$	Heat demand [kW]

### Calculation

$$\dot{V}_{PU} = \frac{227}{1.16 \cdot 6} \text{ m}^3/\text{h}$$

$$\dot{V}_{PU} = 32.61 \text{ m}^3/\text{h}$$

### Operating data specifications

Flow	32.61 m <sup>3</sup> /h
Delivery head	4.65 m
Pumped fluid	Water
Fluid temperature	6 °C
Density	0.9999 kg/dm <sup>3</sup>
Kinematic viscosity	1.474 mm <sup>2</sup> /s
Vapor pressure	0.1 bar

### Hydraulic data (duty point)

Flow	32.6 m <sup>3</sup> /h
Delivery head	4.65 m
Power consumption P1	0.699 kW

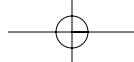

## EXAMPLES FOR THE PUMP SELECTION IN THE COLD WATER CIRCUIT

Wilo-Stratos 65/1-12 PN 6/10 is the choice. This pump is low-maintenance and works with little energy. To protect against corrosion by condensation water, the pump is equipped with a Wilo-ClimaForm.

By monitoring the open position of the control valves, the pump is to be switched off when the valves are closed to protect against running dry. If this isn't possible, for example because the distances of the distributor line are too long, an overflow of 10% is to be permanently ensured at the ends of the distributor line (see short section in the schematic diagram). Note: It may be necessary to dimension the pump larger!

Cavitation can be ruled out since this is a closed circuit. For protection, the vaporiser circuit should have its own safety valve and be equipped with its own diaphragm extension vessel for a volume expansion of 5 to 7 %.

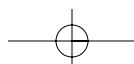
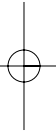
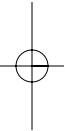

## EXAMPLES FOR THE PUMP SELECTION IN THE COLD WATER CIRCUIT

### Flow rate control with distributor valve

#### Flow rate control with distributor valves and pump performance adjustment

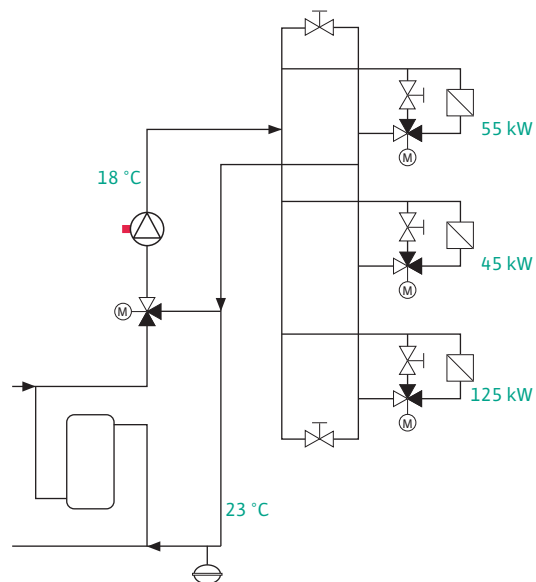

For maintaining the temperature in the controlled system of the load, a flow rate control with distributor valves is selected. The pump requires a flow of 10% at the duty point for the smallest load, which is ensured via throttle valves or volume limiters in the admix line.

The flow is determined as follows:

#### Formula for volume flow $V_{PU}$

$$V_{PU} = \frac{\dot{Q}_N}{1.16 \cdot \Delta\vartheta} \text{ m}^3/\text{h}$$

#### Abbreviation Description

1.16	Spec. heat capacity [Wh/kgK]
$\Delta\vartheta$	Dimensioned temperature difference [K]
$\dot{Q}_N$	Heat demand [kW]

#### Calculation

$$V_{PU} = \frac{227}{1.16 \cdot 5} \text{ m}^3/\text{h}$$

$$V_{PU} = 38.79 \text{ m}^3/\text{h}$$

Since a long pipe section is to be overcome up to the loads, a  $\Delta p$ -v controlled pump can be selected. In the load circuit, only 4 m is required from the 8.2 m delivery head of the pump.

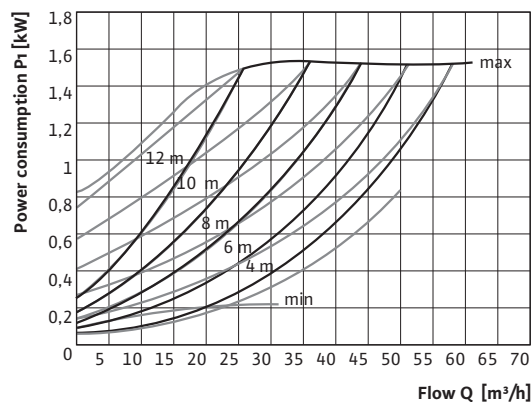
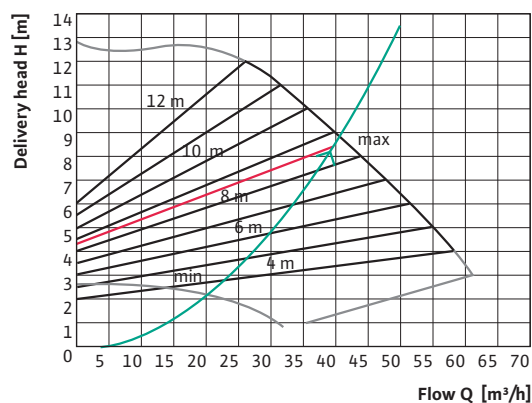

#### Operating data specifications

Flow	38.79 m <sup>3</sup> /h
Delivery head	8.2 m
Pumped fluid	Water
Fluid temperature	18 °C
Density	0.9966 kg/dm <sup>3</sup>
Kinematic viscosity	1.053 mm <sup>2</sup> /s
Vapor pressure	0.1 bar

#### Hydraulic data (duty point)

Flow	38.8 m <sup>3</sup> /h
Delivery head	8.2 m
Power consumption P1	1.34 kW

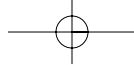

## EXAMPLES FOR THE PUMP SELECTION IN THE COLD WATER CIRCUIT

Only the Wilo-Stratos 80/1-12 is a good choice considering the low maintenance and operating costs. The setpoint curve to be adjusted in the controlled state runs between 8.6 m (max. speed) and 4.3 m (min. control speed). This guarantees that only a maximum of 10% of the dimensioned volume flows for maintaining the temperature in the distributor circuit when the bypass section is correctly configured.

Cavitation can be ruled out since this is a closed circuit. For protection, the vaporiser circuit should have its own safety valve and be equipped with its own diaphragm extension vessel for a volume expansion of 5 to 7 %.

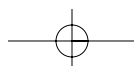
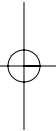
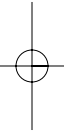

## EXAMPLES FOR THE PUMP SELECTION IN THE COLD WATER CIRCUIT

### Admixing circuit for temperature control

#### Admixing circuit with three-way valves and pump performance adjustment

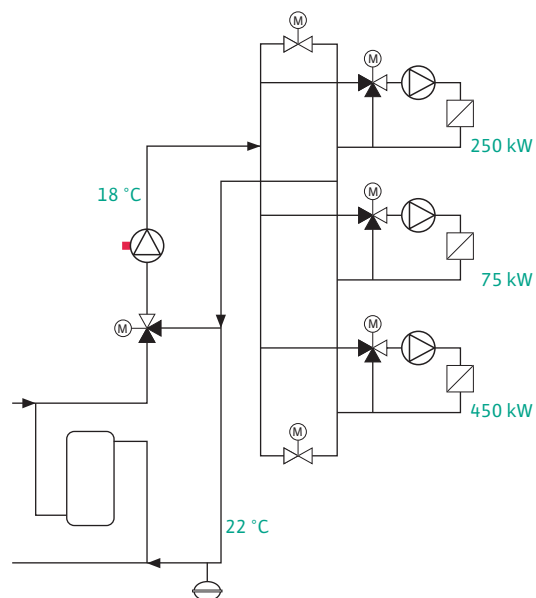

For optimum power adjustment, an admixing circuit directly on the load was selected. Temperature maintenance is not required for the load circuit. The required volume flow is determined as follows:

#### Formula for volume flow $V_{PU}$

$$V_{PU} = \frac{\dot{Q}_N}{1.03 \cdot \Delta\vartheta} \text{ m}^3/\text{h}$$

#### Abbreviation Description

Abbreviation	Description
1.03	Spec. heat capacity [Wh/kgK]
$\Delta\vartheta$	Dimensioned temperature difference [K]
[K]	10–20 K for standard systems
$\dot{Q}_N$	Heat demand [kW]

#### Calculation

$$V_{PU} = \frac{775}{1.03 \cdot 4} \text{ m}^3/\text{h}$$

$$V_{PU} = 188.11 \text{ m}^3/\text{h}$$

The pumping pressure of 16.5 m is taken from the pipework calculation. To protect from frost, the system is operated with a Tyfocor/water mixture (40 % to 60 %). To stabilise the valve authority at the load controllers, a constant differential pressure is demanded at the pump. Instead of a differential pressure valve or a differential pressure controller without auxiliary power, only a controlled pump for energetically favourable operation is taken into consideration.

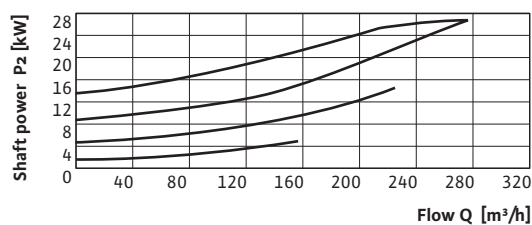
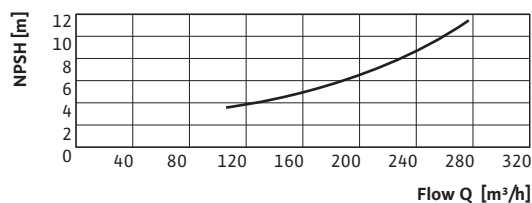
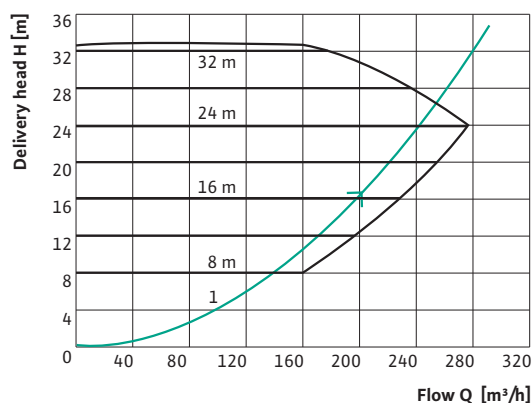

#### Operating data specifications

Flow	188.1 m <sup>3</sup> /h
Delivery head	16.5 m
Pumped fluid	Tyfocor L (40%)
Fluid temperature	18 °C
Density	1.061 kg/dm <sup>3</sup>
Kinematic viscosity	4.14 mm <sup>2</sup> /s
Vapor pressure	1 bar

#### Hydraulic data (duty point)

Flow	188 m <sup>3</sup> /h
Delivery head	16.5 m
Power consumption P1	13.1 kW
NPSH	6.58 m
Impeller diameter	0 mm
Minimum volume flow	20 m <sup>3</sup> /h at $\Delta p=16.5$ m



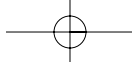

## EXAMPLES FOR THE PUMP SELECTION IN THE COLD WATER CIRCUIT

The selected Wilo-CronoLine-IL-E 100/8-33 BF R1 requires a minimum circulation of 20 m<sup>3</sup>/h, which is to be ensured with overflow sections. If the opening positions of the load controllers are set above 90% to admixing, differential pressure valves are opened by electromotors to protect the pump.

Cavitation can be ruled out since this is a closed circuit. For protection, the vaporiser circuit should have its own safety valve and be equipped with its own diaphragm extension vessel for a volume expansion of 5 to 7 %.

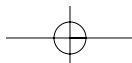
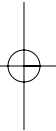
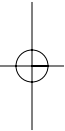

# Examples for the pump selection in the vaporiser circuit

## Vaporiser circuit with constant volume flow

The circuit of a load system is specified with a pressure loss of 13.1 m. The pressure for the vaporiser (5 m) is to be added. The pump must achieve a delivery head of at least 18.1 m.

The selected pump is the Wilo-CronoLine-IL 50/260-3/4.

Cavitation can be ruled out since this is a closed circuit. For protection, the vaporiser circuit should have its own safety valve and be equipped with its own diaphragm extension vessel for a volume expansion of 5 to 7 %.

### Distribution connection in the vaporiser circuit in front of the loads

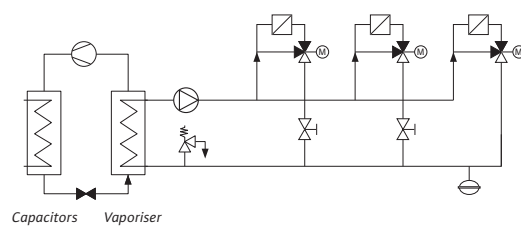

The circulated volume is determined as follows:

### Formula for volume flow $V_{PU}$

$$V_{PU} = \frac{\dot{Q}_N}{1.16 \cdot \Delta\vartheta} \text{ m}^3/\text{h}$$

Abbreviation	Description
1.16	Spec. heat capacity [Wh/kgK]
$\Delta\vartheta$	Dimensioned temperature difference [K]
$\dot{Q}_N$	Heat demand [kW]

### Calculation

$$V_{PU} = \frac{200}{1.16 \cdot 6} \text{ m}^3/\text{h}$$

$$V_{PU} = 28.74 \text{ m}^3/\text{h}$$

A pump with a flow rate of  $Q = 28.74 \text{ m}^3/\text{h}$  and  $H = 18.1 \text{ m}$  is to be selected.

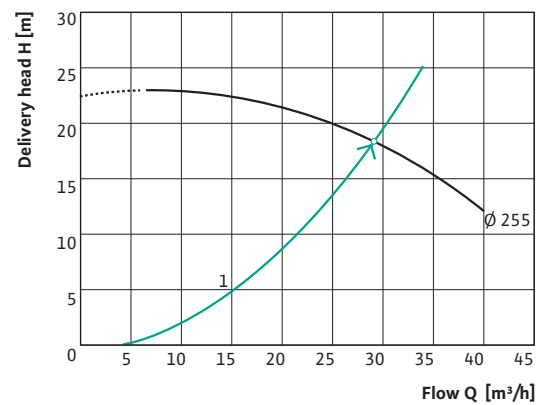

### Operating data specifications

Flow	28.74 m <sup>3</sup> /h
Delivery head	18.1 m
Pumped fluid	Water
Fluid temperature	16 °C
Density	0.9989 kg/dm <sup>3</sup>
Kinematic viscosity	1.11 mm <sup>2</sup> /s
Vapor pressure	0.1 bar

### Hydraulic data (duty point)

Flow	29 m <sup>3</sup> /h
Delivery head	18.4 m
Shaft power P2	2.66 kW
Speed	1450 rpm
NPSH	2.56 m
Impeller diameter	255 mm

EXAMPLES FOR THE PUMP SELECTION IN THE VAPORISER CIRCUIT

Hydraulic decoupler in vaporiser circuit

The circuit of a vaporiser system, including the hydraulic decoupler, is specified with a pressure loss of 5.85 m. The pump must achieve a delivery head of at least 5.85 m. The circulated volume is determined as follows:

Formula for volume flow  $V_{PU}$

$$V_{PU} = \frac{\dot{Q}_N}{1.16 \cdot \Delta\vartheta} \text{ m}^3/\text{h}$$

Abbreviation Description

1.16	Spec. heat capacity [Wh/kgK]
$\Delta\vartheta$	Dimensioned temperature difference
[K]	2-12 K for standard systems
$\dot{Q}_N$	Heat demand [kW]

Calculation

$$V_{PU} = \frac{223}{1.16 \cdot 4} \text{ m}^3/\text{h}$$

$$V_{PU} = 48.1 \text{ m}^3/\text{h}$$

A pump with a flow rate of  $Q = 43.1 \text{ m}^3/\text{h}$  and  $H = 5.85 \text{ m}$  is to be selected.

Hydraulic decoupler in vaporiser circuit

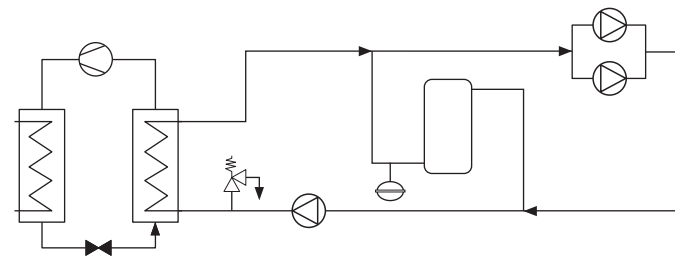

Capacitors Vaporiser

To minimise the operating and maintenance costs, a glandless pump, Wilo-Stratos 80/1-12, is selected. It is advantageous that this pump circuit does not have to be equipped with a regulation valve for the concrete duty point setting. This is set using the reference value control of the pump.

Cavitation can be ruled out since this is a closed circuit. For protection, the vaporiser circuit should have its own safety valve and be equipped with its own diaphragm extension vessel for a volume expansion of 5 to 7 %.

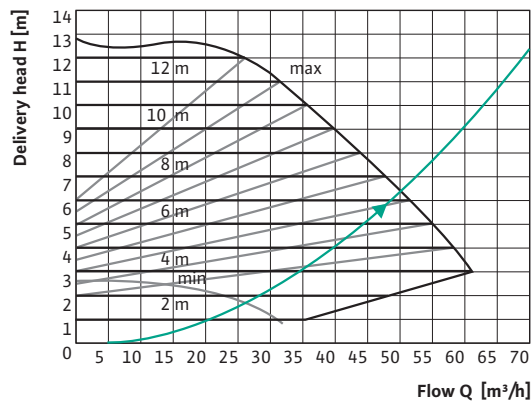

Operating data specifications

Flow	48.1 m <sup>3</sup> /h
Delivery head	5.85 m
Pumped fluid	Water
Fluid temperature	16 °C
Density	0.9989 kg/dm <sup>3</sup>
Kinematic viscosity	1.11 mm <sup>2</sup> /s
Vapor pressure	0.1 bar

Hydraulic data (duty point)

Flow	48.1 m <sup>3</sup> /h
Delivery head	5.85 m
Power consumption P1	1.37 kW

## EXAMPLES FOR THE PUMP SELECTION IN THE VAPORISER CIRCUIT

### Vaporiser circuit with ice storage

To ensure the functional sequence, an Antifrogen L / water mixture (40 % to 60 %) is selected as the fluid to be pumped. The volume flow is determined as follows:

#### Formula for volume flow $V_{PU}$

$$V_{PU} = \frac{\dot{Q}_N}{1.02 \cdot \Delta\vartheta} \text{ m}^3/\text{h}$$

#### Abbreviation Description

1.02	Spec. heat capacity [Wh/kgK]
$\Delta\vartheta$	Dimensioned temperature difference [K]
	10–20 K for standard systems
$\dot{Q}_N$	Heat demand [kW]

#### Calculation

$$V_{PU} = \frac{100}{1.02 \cdot 3} \text{ m}^3/\text{h}$$

$$V_{PU} = 32.68 \text{ m}^3/\text{h}$$

The system pressure losses are assumed to be 9 m from the calculation model. The preliminary pump data is to be determined with the following steps.

#### Step 1

$$B = 2.80 \cdot \frac{(15.41)^{0.50}}{(32.68)^{0.25} \cdot (9)^{0.125}} = 3.49$$

#### Step 2

$$C_Q \approx C_H \approx (2.71)^{-0.165} \cdot (\log 3.49)^{3.15} \approx 0.98$$

#### Step 3

$$Q_W = \frac{32.68}{0.976} = 33.48 \text{ m}^3/\text{h}$$

$$H_W = \frac{9}{0.98} = 9.22 \text{ m}$$

#### Ice storage operation with 100 kW and a fluid temperature of $-4^\circ\text{C}$

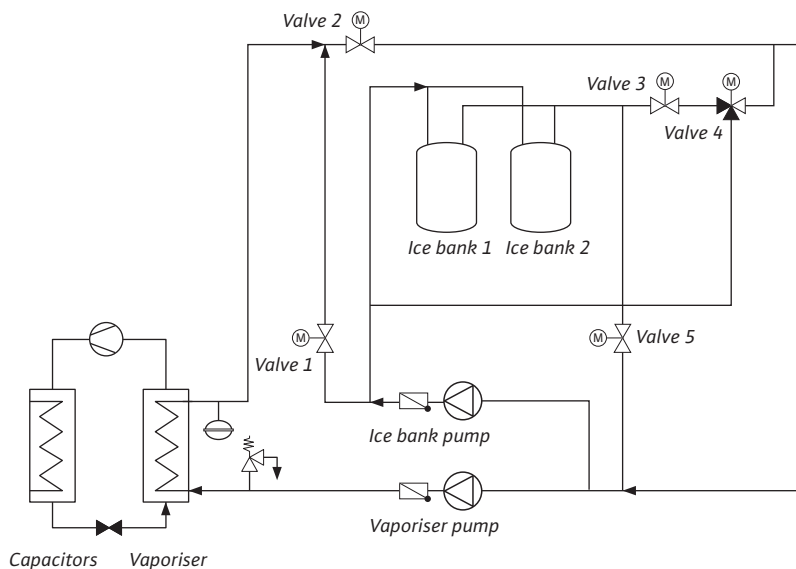

## EXAMPLES FOR THE PUMP SELECTION IN THE VAPORISER CIRCUIT

### Step 4

**Wilo-Stratos 80/1-12 in ice storage mode at 100 kW**

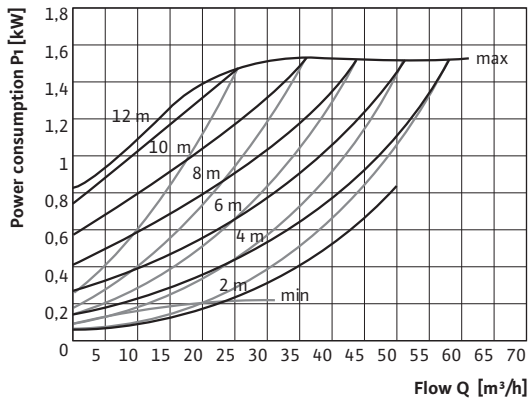
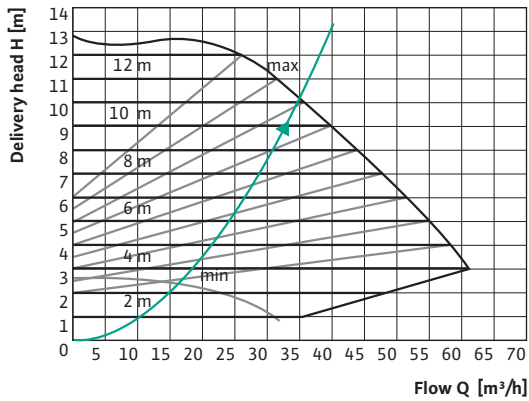

#### Operating data specifications

Flow	33.48 m <sup>3</sup> /h
Delivery head	9.22 m
Pumped fluid	Water
Fluid temperature	20 °C
Density	0.9982 kg/dm <sup>3</sup>
Kinematic viscosity	1.001 mm <sup>2</sup> /s
Vapor pressure	0.1 bar

#### Hydraulic data (duty point)

Flow	33.5 m <sup>3</sup> /h
Delivery head	9.22 m
Power consumption P1	1.34 kW
Vapor pressure	0.1 bar

#### Motor Data

Nominal power P2	1.3 kW
Power consumption P1	1.57 kW
Rated motor speed	3300 rpm
Nominal voltage	11.34 kW~230 V, 50 Hz
Max. current consumption	6.8 A
Protection class	IP 44
Permitted voltage tolerance +/-	10

### Step 5

$$C_{\eta} = 3.49^{-(0.0547 \cdot 3.49^{0.69})} = 0.85$$

$$\eta_{vis} = 0.85 \cdot 0.66 = 0.56$$

### Step 6

$$P_{vis} = \frac{33.48 \cdot 9.22 \cdot 1.053}{367 \cdot 0.56} = 1.58 \text{ kW}$$

The selected Wilo-Stratos 80/1-12 is dimensioned at its capacity limit. It isn't possible to reduce the operating temperature to under -4°C. Operation at -3°C at otherwise the same original data is better.

Cavitation can be ruled out since this is a closed circuit. For protection, the vaporiser circuit should have its own safety valve and be equipped with its own diaphragm extension vessel for a volume expansion of 5 to 7 %.

## EXAMPLES FOR THE PUMP SELECTION IN THE VAPORISER CIRCUIT

### Vaporiser circuit with variable volume flow

#### Hydraulic decoupler in the vaporiser circuit with temperature regulation for the circulating pump

The circuit of a vaporiser system, including the hydraulic decoupler, is specified with a pressure loss of 5.85 m. The pump must achieve a delivery head of at least 5.85 m. Due to the stepped power adjustment of the vaporiser, its flow capacity can be changed between 30 % and 100 %.

#### Hydraulic decoupler in the vaporiser circuit with temperature regulation for the circulating pump

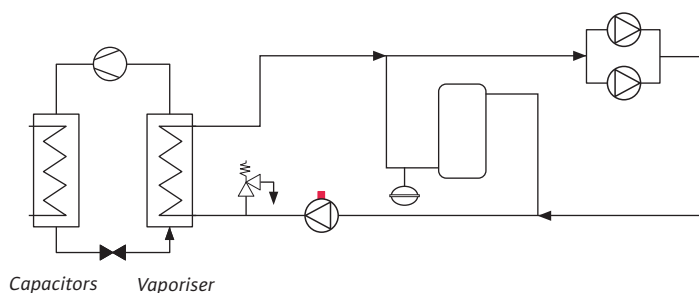

The circulated volume is determined as follows:

#### Formula for volume flow $V_{PU}$

$$V_{PU} = \frac{\dot{Q}_N}{1.16 \cdot \Delta\vartheta} \text{ m}^3/\text{h}$$

Abbreviation	Description
1.16	Spec. heat capacity [Wh/kgK]
$\Delta\vartheta$	Dimensioned temperature difference [K]
	2–12 K for standard systems
$\dot{Q}_N$	Heat demand [kW]

#### Calculation

$$V_{PU} = \frac{200}{1.16 \cdot 4} \text{ m}^3/\text{h}$$

$$V_{PU} = 43.1 \text{ m}^3/\text{h}$$

A pump with a flow rate of  $Q = 43.1 \text{ m}^3/\text{h}$  and  $H = 5.85 \text{ m}$  is to be selected.

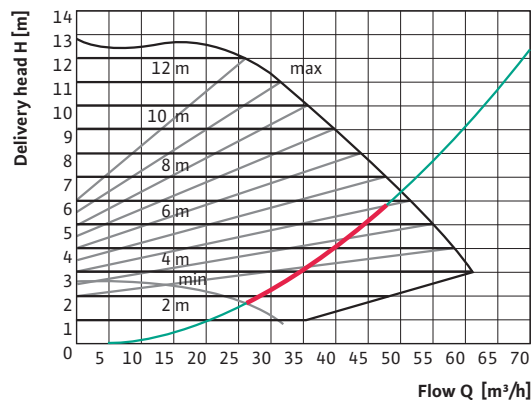

#### Operating data specifications

Flow	43.1 m <sup>3</sup> /h
Delivery head	5.85 m
Pumped fluid	Water
Fluid temperature	16 °C
Density	0.9989 kg/dm <sup>3</sup>
Kinematic viscosity	1.11 mm <sup>2</sup> /s
Vapor pressure	0.1 bar

#### Hydraulic data (duty point)

Flow	48.1 m <sup>3</sup> /h
Delivery head	5.85 m
Power consumption P1	1.37 kW

To minimise the operating and maintenance costs, a glandless pump, a Wilo-Stratos 80/1-12 with a LON module, is selected. It is advantageous that this pump circuit doesn't have to be equipped with a regulation valve for the concrete duty point setting. Adjustment is done with a machine controller. The pump is specified appropriately for the cooling capacity and fluid temperature of the required setpoint. A manual control mode of the pump is also possible. Every desired flow between 20 m<sup>3</sup>/h and 48.1 m<sup>3</sup>/h can be set by concretely specifying a speed.

Cavitation can be ruled out since this is a closed circuit. For protection, the vaporiser circuit should have its own safety valve and be equipped with its own diaphragm extension vessel for a volume expansion of 5 to 7 %.

## EXAMPLES FOR THE PUMP SELECTION IN THE VAPORISER CIRCUIT

### Distributor circuit and variable volume flow in the vaporiser circuit

In the common circuit of the vaporiser and loads, the flow volume can be variably adapted to the demands. The vaporiser may be operated between 17.5 m<sup>3</sup>/h and 43.1 m<sup>3</sup>/h. The resistances in the distributor line up to the first outlet of an ascending pipe, including the vaporiser, amount to 9.0 m. 3.0 m are required at full capacity for the connection of the ascending pipes, including loads.

Based on the declining pressure demand in the generator part, a delivery head of 4.48 m is required at a flow rate of 17.3 m<sup>3</sup>/h.

A Wilo-Veroline-IP-E 80/115-2.2/2 was selected. By means of an onsite controller, the pump can be specified to the operating requirements of the adapted setpoint. Alternatively, the ascending pipe – with the greatest pressure demand in the generator part and feeder pipe – can be equipped with a differential pressure sensor. The control curve is shown in red in the figure to the right.

The demanded minimum volume flow of 17.5 m<sup>3</sup>/h is guaranteed by presetting the distributor and bypass volumes.

Cavitation can be ruled out since this is a closed circuit. For protection, the vaporiser circuit should have its own safety valve and be equipped with its own diaphragm extension vessel for a volume expansion of 5 to 7 %.

### Distributor circuit and variable volume flow in the vaporiser circuit

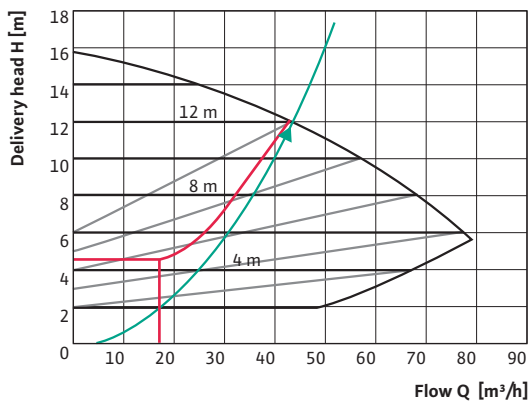
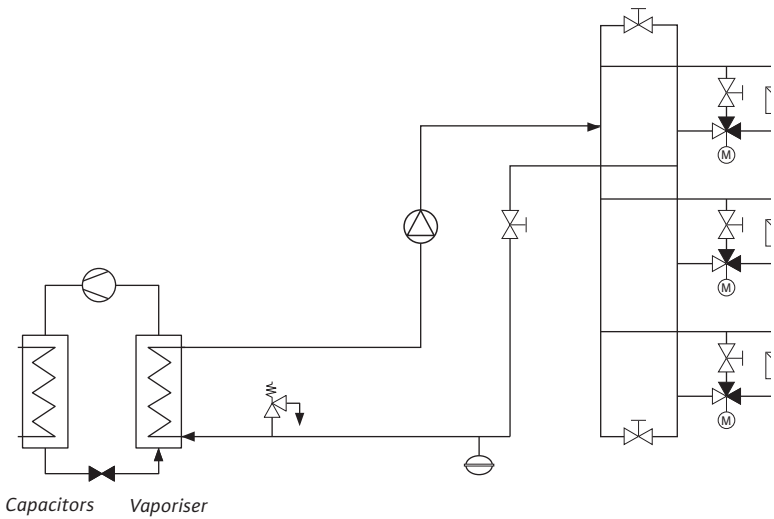

#### Operating data specifications

Flow	43.1 m <sup>3</sup> /h
Delivery head	12 m
Pumped fluid	Water
Fluid temperature	16 °C
Density	0.9989 kg/dm <sup>3</sup>
Kinematic viscosity	1.11 mm <sup>2</sup> /s
Vapor pressure	0.1 bar

#### Hydraulic data (duty point)

Flow	43.1 m <sup>3</sup> /h
Delivery head	12 m
Shaft power P <sub>2</sub>	kW
Speed	2880 rpm
NPSH	1.99 m
Impeller diameter	115 mm

## EXAMPLES FOR THE PUMP SELECTION IN THE V- CIRCUIT

### Flow rate control in the vaporiser circuit

Vaporisers which have a distributor pump and mixing circuit pumps in their hydraulic system can have different flows. In order to maintain good controllability of the circuit, a constant volume flow is required under certain preconditions. By means of a measuring orifice and a pressure transducer, the pump can keep the flow constant within its duty chart.

At a power reduction of 350 kW cooling capacity, a volume flow of 50 m<sup>3</sup>/h is required. If all secondary circuits are closed, this volume flows via the short circuit. If all secondary circuits pull water out of the primary circuit, an additional differential pressure of 3 m is created. This means that the primary circuit pump no longer has to build up a differential pressure of 5.8 m, but only of 2.8 m.

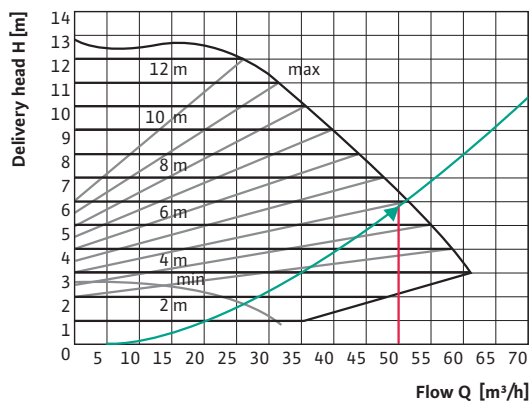

### Operating data specifications

Flow	50 m <sup>3</sup> /h
Delivery head	5.8 m
Pumped fluid	Water
Fluid temperature	6 °C
Density	0.9989 kg/dm <sup>3</sup>
Kinematic viscosity	1.474 mm <sup>2</sup> /s
Vapor pressure	0.1 bar

### Vaporiser circuit with measuring orifice

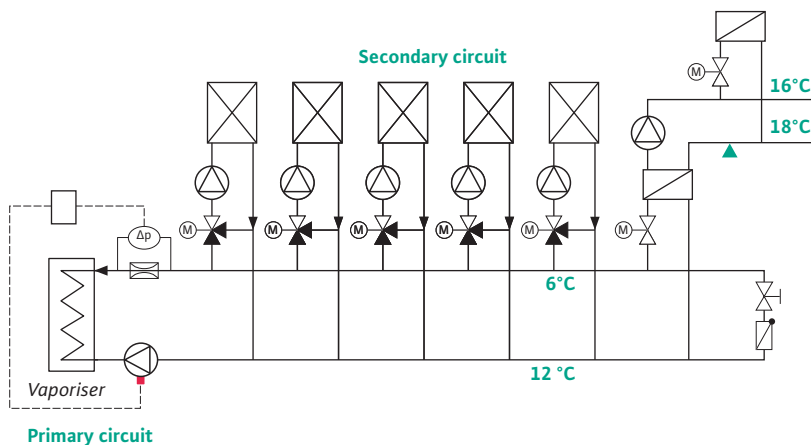

### Hydraulic data (duty point)

Flow	50 m <sup>3</sup> /h
Delivery head	5.8 m
Power consumption P1	1.45 kW

The selected Wilo-Stratos 100/1-12 keeps the volume flow constant (within the regulation difference of the PID controller) in connection with a Wilo CRn system. The differential pressure is kept constant via the measuring orifice; a constant volume flow is automatically set. The valve in the bypass is to be set so that only 50 m<sup>3</sup>/h flow through this at full speed. In the control range of the reduction in the secondary circuits, a pressure drop is created in the feed and a pressure rise in the return. As a result, the flow via the bypass valve will approach zero.

Cavitation can be ruled out since this is a closed circuit. For protection, the vaporiser circuit should have its own safety valve and be equipped with its own diaphragm extension vessel for a volume expansion of 5 to 7 %.



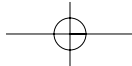
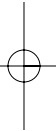
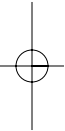
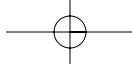

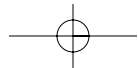
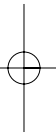
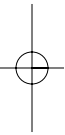
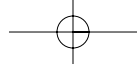

# Economical consideration in the selection of fittings

Different components always belong to a cold-water installation which must be planned and dimensioned specifically for fulfilling the posed air-conditioning or cooling tasks – each separately, especially in interconnected systems. The engineer must also consider the economic constraints at an early point in time. On the one hand, the investment costs, and on the other hand, also the later operating costs and measures which minimise these. Here, the respective efficiencies of the components and of the overall system play a decisive role: Because, depending on the load status (full load / partial load) of the system, the efficiencies can vary, which has a negative effect on the energy demands and the operating costs.

What options are there for optimisation? How can one manage such problems and keep them under control, both in planning and operation? Let's consider the circuit between the water cooler and the load points. The transport of the cooling water from the water cooler to the "users", such as the RLT devices, fan coils, cooling fans, etc. is done by circulating pumps.

Here, the cold water is to be distributed according to utilisation by dimensioning the pipelines (cross-sections) and control valves. Fundamentally, when dimensioning, a minimum and maximum dimensioning value result, which depends on the investment and operating costs. Low investment costs often involve small cross-sections in the pipes and fittings with relatively small pump connections. This solution, however, brings about high pressure losses in the water supply network, and the resulting high operating costs. Conversely, however, higher investment costs don't automatically mean lower operating costs!

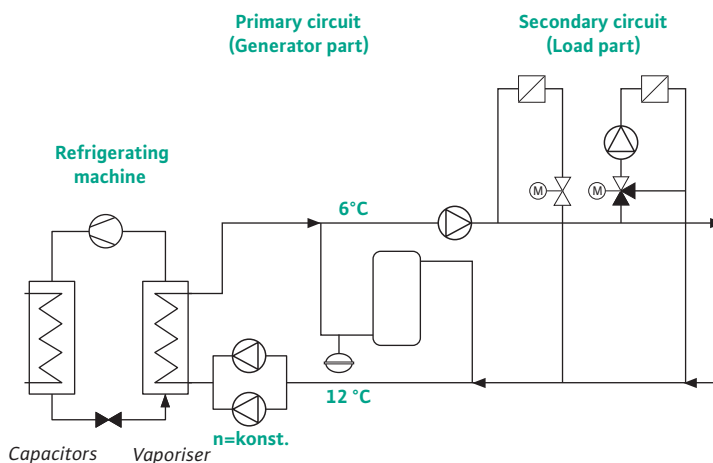

Based on the specific demands of the specified model system, it will be shown that, in practice, components are often planned for the hydraulic network which aren't absolutely necessary.

This often occurs due to ignorance and incorrectly understood safety thinking. Also, this often results in considerable and "avoidable" operating costs. The main task is to consider all components with regard to their behaviour in normal operating situations and the costs they involve. This is that much more important since all these costs make Germany a very highly priced place to do business. The example can be applied to every production, administration or residential area. The physical and economical preconditions are identical. A basis for planning cooling water distributor systems will be presented which will guarantee functionally safe and economic systems in the future.

## ECONOMICAL CONSIDERATION IN THE SELECTION OF FITTINGS

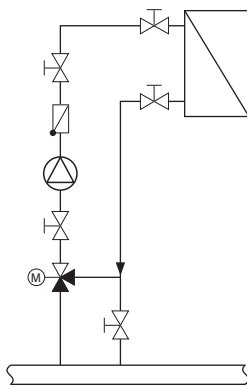

Fittings	Nominal diameter	$k_v$ value
Shut-off valve	50	80
Three-way valve	40	50
Non-return valve		45 50

Separate machine cooling and room air cooling systems were selected for economic reasons. For the machine part, 20200.00 kg/h of a water/glycol mixture are to be moved by the circulating pump. The temperature is controlled by an admixing valve and the loads adapted. Due to the flow volume, a pump with a connection size of DN 50 is sufficient. The pipeline is chosen to have a size of DN 100. In order to keep the building costs down, the isolating valves required before and after the pump for maintenance reasons could be selected to be size DN 50. A  $k_v$  value of 40 for the control valve is to be assumed for a valve authority of approx. 70 % for a very good control. This requires a pump with a delivery pressure of 91 kPa. For operation of approx. 3800 hours per year and an electricity rate of € 0.15, this makes € 604.00 in annual operating costs.

Alternatively, the installation of shut-off valves in size DN 100 is possible, with a control valve with a  $k_v$  value of 50 and a valve authority of approx. 44 %. If a tightly closing valve is selected, the shut-off valve can be omitted. The required delivery pressure of the pump is then only 71 kPa. The annual operating costs are then only € 457.00. This alternative over a time span of 12 years means that € 1764.00 can be saved assuming energy costs stay the same. For approx. € 300.00 more in investment costs, which pays for itself in less than 2 years in saved operating costs, there is a savings of € 147.00 for every year after that.

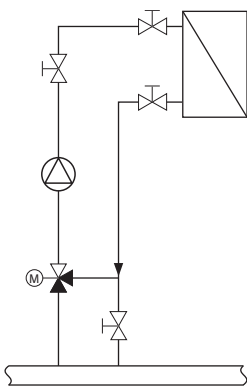

Fittings	Nominal diameter	$k_v$ value
Shut-off valve	100	800
Three-way valve	100	50
Non-return valve	—	—

The other hydraulic circuits are to be considered under the same aspects. Usually, higher  $k_v$  values can be selected for control valves and shut-off valves at high control quality with the big advantage of lowered operating costs and amortisation in less than 2 years.

The non-return valve is installed so that there is no incorrect circulation. When tightly closing control valves are used, this can be omitted. In order to prevent undesired circulation within the pipe due to gravitational effects, the sensible pipe dimensioning should be given special attention.

## ECONOMICAL CONSIDERATION IN THE SELECTION OF FITTINGS

Commercially available flap traps must be operated with a differential pressure of over 10 kPa. Lower differential pressures mean that the flaps work at an unstable duty point, which results in noise and unstable operating states. In two-pipe systems with variable volume flows, the smallest flow is to be determined for stable operation. For this flow, a flap resistance of more than 10 kPa is to be planned. For the full-load state, then, differential pressures of more than 50 kPa are only to be overcome for the flap trap of the circulating pump. Additional operating costs are created which can add up to approx. € 130.00 to 3643.00 per year depending on the efficiency of the pump at a flow rate of 1 to 70 m<sup>3</sup>/h. In this example, a shut-off valve or a ball valve with an actuator is recommended for the cooling water side of the air-conditioning system for blocking the two network pumps which automatically close when the operation of the line isn't required. This results in approx. € 656.00 less in operating costs per year.

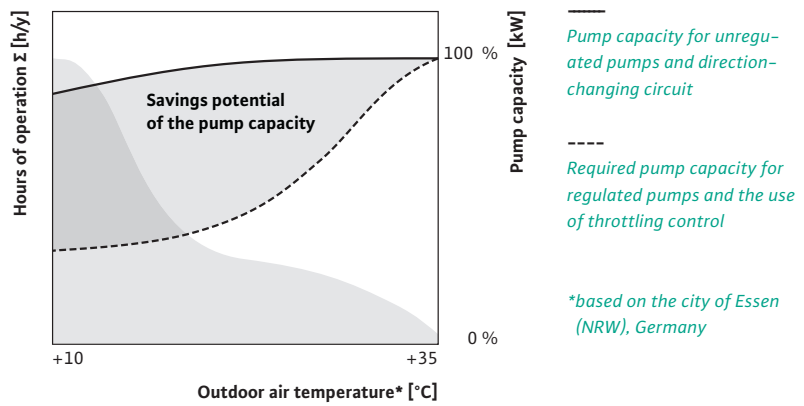

# Appendix

## Standards

(Translator's note: In this and the following two sections, the titles are free translations and not official titles.)

### **DIN EN 1151-1** **Standard, 2006-11**

Pumps – Centrifugal pumps – Circulating pumps with electric power consumption up to 200 W for heating systems and process water heating systems for domestic use – Part 1: Non-automatic circulating pumps, requirements, testing, designation; German version EN 1151-1:2006

### **DIN EN 1151-2** **Standard, 2006-11**

Pumps – Centrifugal pumps – Circulating pumps with electric power consumption up to 200 W for heating systems and process water heating systems for domestic use – Part 2: Noise testing regulation (vibro-acoustical) for measuring structure-borne noise and fluid-borne noise; German version EN 1151-2:2006

### **DIN ISO 9905 Amendment 1** **Standard, 2006-11**

Centrifugal pumps – Technical requirements – Class I (ISO 9905:1994), amendments to DIN ISO 9905:1997-03; German version EN ISO 9905:1997/AC:2006

### **DIN ISO 10816-7** **Standard draft, 2007-03**

Mechanical vibrations – Assessment of machine vibrations by means of measurements on non-rotating parts – Part 7: Centrifugal pumps for industrial use (including measurement of shaft vibrations); ISO/DIS 10816-7:2006

### **DIN V 4701-10 Supplement 1** **Preliminary standard, 2007-02**

Energetic assessment of heating and air-conditioning systems – Part 10: Heating, potable water heating, ventilation; Supplement 1: System Examples

### **DIN V 4701-10/A1** **Preliminary standard, 2006-12**

Energetic assessment of heating and air-conditioning systems – Part 10: Heating, potable water heating, ventilation;

### **DIN EN 13831** **Standard draft, 2007-02**

Expansion tanks with built-in membrane for installation in water systems; German version prEN 13831:2007

### **ISO/TR17766**

Technical report  
Centrifugal pumps for viscous fluids – Corrections of performance features

### **DIN EN 809**

Pumps and pump units for fluids – General safety requirements; German version EN 809:1998

### **EN ISO 5198**

Rules for measuring the hydraulic operating behaviour – Precision class (ISO 5198:1987); German version EN 5198:1998

### **EN ISO 9906**

Centrifugal pumps. Hydraulic acceptance test – Classes 1 and 2; (ISO 9906:1999); German version EN ISO 9906:1999

### **Fluid pumps**

General terms for pumps and pump systems, definitions, sizes, formula characters and units; German version EN 12723:2000

DIN 24901: Graphic symbols for technical drawings – Fluid pumps

DINEN 22858: Centrifugal pumps with axial inlets

DINEN 12262: Centrifugal pumps – Technical documentation – Terms, scope of delivery, design; German version EN 12262:1998

DIN 24250: Centrifugal pumps – Naming and numbering of components – Collection DIN home technology

## Handbooks

2007, DIN paperback book 35  
Noise protection – Requirements, verifications, calculation methods and building-related acoustical tests

2007, DIN paperback book 85  
Ventilation systems VOB (German construction contract procedures)/STLB – building – VOB Part B: DIN 1961, VOB Part C: ATV DIN 18299, ATV DIN 18379

2007, DIN paperback book 171  
Pipes, pipeline parts and pipe connections made of reaction resin moulding materials

2007, DIN paperback book 386  
Refrigerating technology 1 – Safety and environmental protection – Cooling systems

2007, DIN paperback book 387  
Refrigerating technology 2 – Cooling devices, vehicle cooling

2007, DIN paperback book 388  
Refrigerating technology 3 – Components, operating and auxiliary materials

VDI Handbook – Air-conditioning Technology

VDI Handbook – Heating Technology

## VDMA unit sheet

24186-3 2002-09  
Range of products for maintaining technical systems and equipment in buildings – Part 3: Cooling devices and systems for the purpose of cooling and heating

24186-5 2002-09  
Range of products for maintaining technical systems and equipment in buildings – Part 5: Electrical devices and systems

1988-10  
CAD standard part file; Requirements for geometry and features; Drawing symbols, fluid pumps, compressors, fans, vacuum pumps

24222 1998-05 Fluid pumps – Heating pumps – Data items for fieldbus systems

24252 1991-04  
Centrifugal pumps with wear walls PN 10 (wash-water pumps) with bearing brackets; Designation, nominal power, main dimensions

24253 1971-02  
Centrifugal pumps with housing armour (armoured pumps); single-stream, single-stage, with axial inlet; Performance, main dimensions

24261-1 1976-01  
Pumps; Naming according to way it works and design features; Centrifugal pumps

24261-3 1975-07  
Pumps; Naming according to way it works and design features; Rotating displacement pumps

24277 2003-07  
Fluid pumps – Installation – Low-tension pipeline connection

24278 2002-07  
Replacement for Issue 2000-04  
Centrifugal pumps – EDV size selection program – Specification document (with associated electronic version of table B.1 "Field definitions" from Appendix B and an editor for making handling easier)

24279 1993-04  
Centrifugal pumps; Technical requirements; Magnetic coupling and canned motor pumps

24280 1980-11  
Displacement pumps; Terms, symbols, units

24284 1973-10  
Testing of displacement pumps; General testing rules

24292 1991-08  
Fluid pumps; Installation and operating instructions for pumps and pump units; Outline, checklist, text block – safety

24901-5 1988-10  
Graphical symbols for technical drawings; Fluid pumps; Illustration in flow charts

APPENDIX

Tables and guide values

Loss coefficient

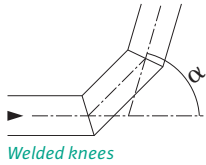
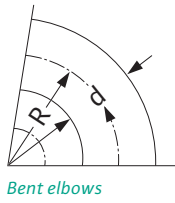

$\alpha$	15°		30°		45°		60°		90°	
	Surface smooth	rough	Surface smooth	rough	Surface smooth	rough	Surface smooth	rough	Surface smooth	rough
$\zeta$ for $R = 0$	0.07	0.10	0.14	0.20	0.25	0.35	0.50	0.70	1.15	1.30
$\zeta$ for $R = d$	0.03	–	0.0–	–	0.14	0.34	0.19	0.46	0.21	0.51
$\zeta$ for $R = 2 d$	0.03	–	0.06	–	0.09	0.19	0.12	0.26	0.14	0.30
$\zeta$ for $R \geq 5 d$	0.03	–	0.06	–	0.08	0.16	0.10	0.20	0.10	0.20

Number of circumferential weld seams

	–	–	–	–	2	–	3	–	3	–
$\zeta$	–	–	–	–	0.15	–	0.20	–	0.25	–

$Q_a/Q =$	0.2	0.4	0.6	0.8	1
	$\zeta_a = -0.4$ $\zeta_d = -0.17$	0.08 0.30	0.47 0.41	0.72 0.51	0.91 –
	$\zeta_a = 0.88$ $\zeta_d = -0.88$	0.89 -0.05	0.95 0.07	1.10 0.21	1.28 –
	$\zeta_a = -0.38$ $\zeta_d = 0.17$	0 0.19	0.22 0.09	0.37 -0.17	0.37 –
	$\zeta_a = 0.68$ $\zeta_d = -0.06$	0.50 -0.04	0.38 0.07	0.35 0.20	0.48 –

The  $\zeta$ -value of the simple 90° elbow is not to be doubled when putting several elbows together as follows, but is only to be multiplied by the respectively specified factor in order to get the loss of the multiple elbow.

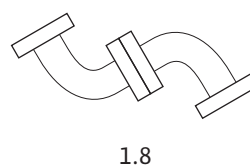
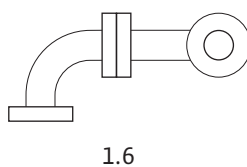
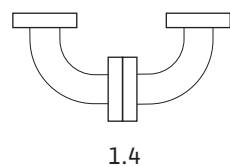



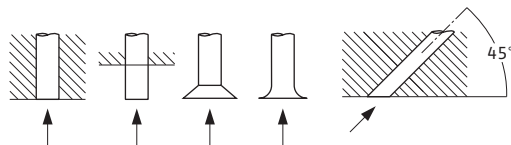

**Inlet edge**

sharp	$\zeta =$	0.53	3	for $\Delta = 75^\circ$ $60^\circ$ $45^\circ$		
broken	$\zeta =$	0.25	0.55	0.20	0.05	$\zeta = 0.6$ $0.7$ $0.8$

Form	d/D		0.5	0.6	0.7	0.8	0.9
1		=	0.56	0.41	0.26	0.13	0.04
2	for $\alpha = 8^\circ$	=	0.07	0.05	0.03	0.02	0.01
	$\alpha = 15^\circ$	=	0.15	0.11	0.07	0.03	0.01
	$\alpha = 20^\circ$	=	0.23	0.17	0.11	0.05	0.02
3		=	4.80	2.01	0.88	0.34	0.11
4	for $20^\circ < \alpha < 40^\circ$	=	0.21	0.10	0.05	0.02	0.01

**Extensions**

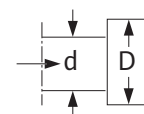

Form 1

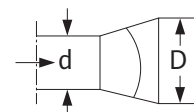

Form 2

**Reducers**

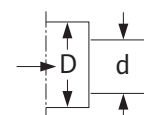

Form 3

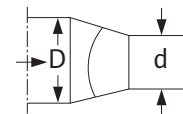

Form 4

APPENDIX

Loss value with DN

Fittings [DN]	10	15	20	25	32	40	50	65	80	100	125	150	200	250	300	350	400	
Flat slide valve	0.65	0.6	0.55	0.5	0.5	0.45	0.4	0.35	0.3	0.3	0.3	0.3	0.3	0.3	0.3	0.3	0.3	
Cocks [d <sub>E</sub> = DN]	0.15																	
Shutters								1.5	0.65	0.4	0.3	0.5	0.6	0.2	0.2	0.2	0.3	0.3
Flat-seat valve									6.0									
Angle-seat valve									2.6									
Free-flow valve									1.6									
Flap traps									3.0									
Foot valve	1.9	9.6	4.3	4.9	3.6	5.2	5.8	4.2	4.4	4.5	4.5	3.3	7.1	6.2	6.3	6.3	6.6	
Angle valve	3.1	3.1	3.1	3.1	3.4	3.8	4.1	4.4	4.7	5.0	5.3	5.7	6.0	6.2	6.3	6.3	6.6	
Expansion bend - bare pipe									0.8									
Expansion bend - folded pipe									1.6									
Expansion bend - corrugated pipe									4.0									
Corrugated pipe compensator with conducting pipe									0.3									

Definition of viscosity

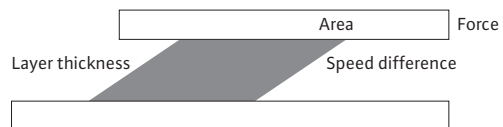

$$\tau = \frac{\text{Force}}{\text{Area}} = \frac{F}{A} \left[ \frac{\text{N}}{\text{m}^2} \right]$$

$$\eta = \frac{\tau}{\dot{\gamma}} = \frac{\text{Speed difference}}{\text{Layer thickness}} = \frac{dv}{dy} \text{ [s}^{-1}\text{]}$$

Pipe frictional losses

PVC pipe

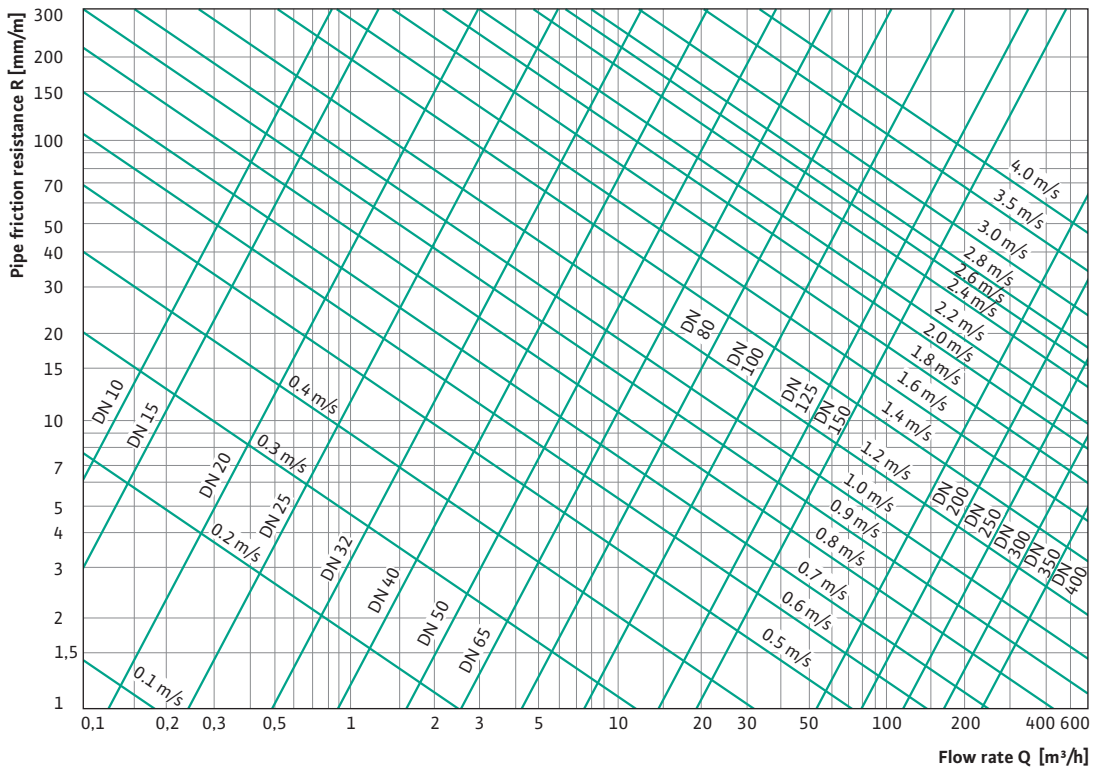

Steel pipe

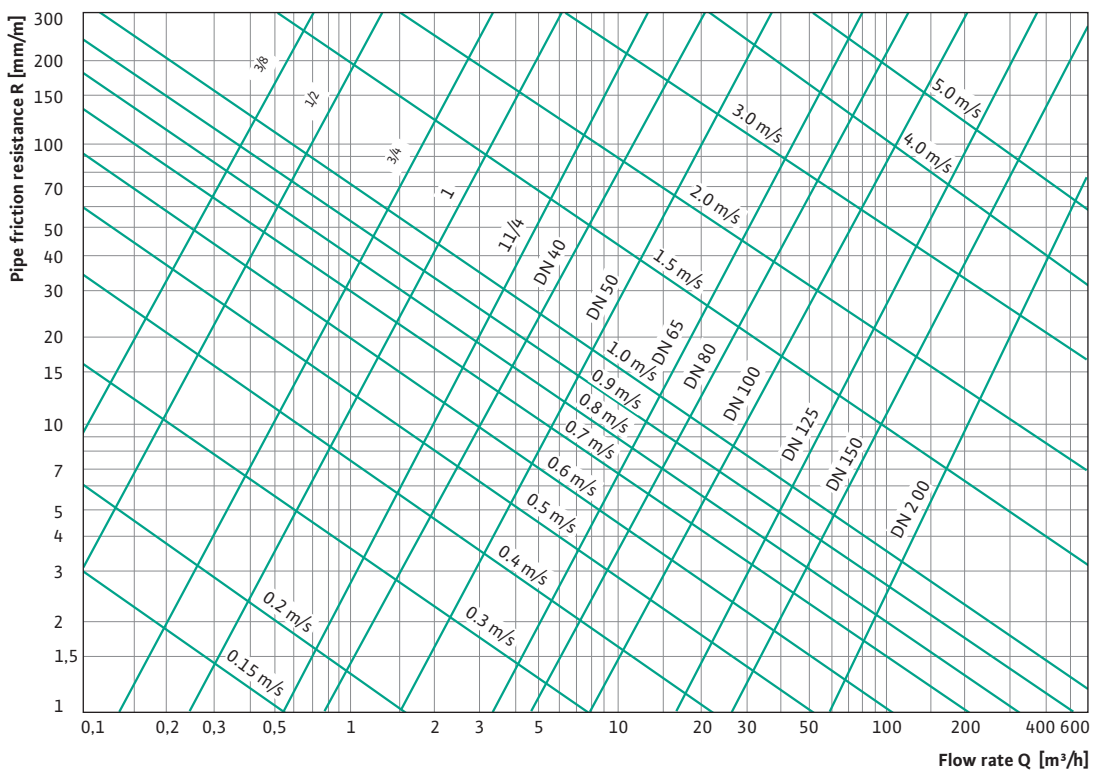

APPENDIX

Ethylene glycol with 40% admixture

Antifrogen N				
Fluid temperature	Density	Kinematic viscosity	Specific heat capacity	Relative pressure loss
[°C]	$\rho$ [kg/m <sup>3</sup> ]	$\nu$ [mm <sup>2</sup> /s]	$c_p$ [kJ/kg·K]	$f_p$
-30	-	-	-	-
-25	1080	26.73	3.43	2.313
-20	1079	18.59	3.44	2.147
-15	1078	13.63	3.45	1.999
-10	1077	10.38	3.46	1.868
-5	1076	8.14	3.47	1.751
0	1074	6.52	3.48	1.646
5	1072	5.33	3.49	1.553
10	1070	4.42	3.5	1.470
15	1068	3.72	3.51	1.396
20	1066	3.16	3.53	1.330
25	1064	2.72	3.54	1.271
30	1062	2.36	3.55	1.219
35	1059	2.07	3.56	1.172
40	1057	1.82	3.57	1.129
45	1054	1.62	3.59	1.091
50	1051	1.45	3.6	1.057
55	1048	1.31	3.61	1.026
60	1045	1.19	3.63	0.998
65	1042	1.09	3.64	0.972
70	1039	1.00	3.66	0.949
75	1036	0.93	3.67	0.927
80	1032	0.86	3.68	0.907
85	1029	0.80	3.7	0.887
90	1025	0.76	3.71	0.869
95	1022	0.71	3.73	0.851
100	1018	0.68	3.74	0.834

Tyfocor			
Density	Kinematic viscosity	Specific heat capacity	Relative pressure loss
$\rho$ [kg/m <sup>3</sup> ]	$\nu$ [mm <sup>2</sup> /s]	$c_p$ [kJ/kg·K]	$f_p$
-	-	-	-
1099	21.9	3.29	2.012
1077	17.1	3.33	1.913
1075	13.4	3.36	1.799
1073	10.6	3.40	1.689
1071	8.49	3.43	1.588
1068	6.85	3.46	1.500
1066	5.57	3.49	1.438
1064	4.58	3.52	1.375
1061	3.81	3.55	1.313
1059	3.19	3.57	1.263
1056	2.70	3.60	1.225
1054	2.31	3.62	1.175
1051	1.99	3.64	1.138
1049	1.73	3.66	1.100
1046	1.52	3.68	1.075
1043	1.34	3.70	1.050
1040	1.20	3.72	1.025
1037	1.08	3.73	0.998
1034	0.99	3.75	0.975
1031	0.91	3.76	0.950
1028	0.85	3.77	0.925
1025	0.79	3.78	0.963
1022	0.75	3.79	0.888
1019	0.72	3.79	0.875
1016	0.69	3.80	0.850
1013	0.67	3.80	0.838

Ethylene glycol with 50% admixture

Antifrogen N				
Fluid temperature	Density	Kinematic viscosity	Specific heat capacity	Relative pressure loss
[°C]	$\rho$ [kg/m <sup>3</sup> ]	$\nu$ [mm <sup>2</sup> /s]	$c_p$ [kJ/kg·K]	$f_p$
-30	1101	71.54	3.17	2.886
-25	1100	43.62	3.18	2.654
-20	1099	29.13	3.20	2.45
-15	1097	20.66	3.21	2.27
-10	1095	15.32	3.23	2.110
-5	1093	11.73	3.24	1.969
0	1091	9.23	3.26	1.844
5	1089	7.42	3.27	1.733
10	1087	6.07	3.29	1.634
15	1085	5.05	3.31	1.547
20	1082	4.25	3.32	1.469
25	1079	3.62	3.34	1.399
30	1077	3.12	3.36	1.338
35	1074	2.71	3.37	1.282
40	1071	2.38	3.39	1.233
45	1068	2.10	3.41	1.188
50	1065	1.88	3.42	1.149
55	1062	1.68	3.44	1.112
60	1059	1.52	3.46	1.080
65	1056	1.38	3.47	1.050
70	1052	1.27	3.49	1.023
75	1049	1.17	3.51	0.997
80	1046	1.08	3.53	0.973
85	1042	1.00	3.54	0.951
90	1038	0.94	3.56	0.930
95	1035	0.88	3.58	0.910
100	1031	0.83	3.60	0.890

Tyfocor			
Density	Kinematic viscosity	Specific heat capacity	Relative pressure loss
$\rho$ [kg/m <sup>3</sup> ]	$\nu$ [mm <sup>2</sup> /s]	$c_p$ [kJ/kg·K]	$f_p$
1099	54.20	2.95	2.463
1096	37.00	2.99	2.250
1094	26.20	3.03	2.063
1091	19.20	3.07	1.938
1088	14.40	3.11	1.802
1086	11.20	3.14	1.738
1083	8.84	3.18	1.601
1081	7.13	3.21	1.550
1078	5.85	3.25	1.463
1075	4.88	3.28	1.412
1072	4.11	3.31	1.350
1070	3.51	3.34	1.300
1067	3.02	3.37	1.250
1064	2.63	3.40	1.213
1061	2.30	3.42	1.175
1058	2.03	3.45	1.150
1055	1.81	3.47	1.100
1052	1.62	3.50	1.750
1048	1.45	3.52	1.500
1045	1.32	3.54	1.020
1042	1.20	3.56	1.000
1038	1.10	3.58	0.975
1035	1.01	3.59	0.963
1031	0.93	3.61	0.938
1027	0.87	3.62	0.913
1024	0.81	3.63	0.888
1020	0.76	3.65	0.875

## APPENDIX

## Propylene glycol with 40% admixture

Antifrogen L				
Fluid temperature	Density	Kinematic viscosity	Specific heat capacity	Relative pressure loss
[°C]	$\rho$ [kg/m <sup>3</sup> ]	$\nu$ [mm <sup>2</sup> /s]	$c_p$ [kJ/kg·K]	$f_p$
-30	-	-	-	-
-25	-	-	-	-
-20	1056	44.42	3.62	2.660
-15	1055	31.09	3.64	2.385
-10	1053	22.25	3.65	2.163
-5	1051	16.34	3.66	1.983
0	1049	12.32	3.68	1.837
5	1047	9.53	3.69	1.716
10	1044	7.53	3.70	1.615
15	1042	6.06	3.71	1.529
20	1039	4.94	3.73	1.454
25	1036	4.08	3.74	1.386
30	1033	3.39	3.75	1.324
35	1030	2.86	3.77	1.266
40	1027	2.43	3.78	1.11
45	1024	2.10	3.79	1.159
50	1020	1.84	3.81	1.109
55	1017	1.63	3.82	1.061
60	1013	1.45	3.84	1.017
65	1010	1.31	3.85	0.977
70	1006	1.17	3.87	0.941
75	1002	1.05	3.88	0.910
80	998	0.95	3.89	0.885
85	994	0.85	3.91	0.865
90	991	0.77	3.92	0.849
95	987	0.72	3.94	0.838
100	983	0.68	3.95	0.829

Tyfocor L			
Density	Kinematic viscosity	Specific heat capacity	Relative pressure loss
$\rho$ [kg/m <sup>3</sup> ]	$\nu$ [mm <sup>2</sup> /s]	$c_p$ [kJ/kg·K]	$f_p$
-	-	-	-
-	-	-	-
1059	44.7	3.53	2.405
1057	30.4	3.55	2.233
1055	21.4	3.57	2.033
1052	15.4	3.59	2.170
1050	11.4	3.61	1.805
1048	8.62	3.63	1.717
1045	6.69	3.64	1.600
1042	5.30	3.66	1.467
1040	4.28	3.68	1.350
1037	3.53	3.70	1.300
1037	2.96	3.72	1.233
1031	2.52	3.74	1.183
1028	2.18	3.76	1.150
1025	1.90	3.78	1.100
1022	1.69	3.79	1.067
1019	1.51	3.81	1.033
1015	1.36	3.83	1.017
1012	1.24	3.85	0.983
1008	1.14	3.87	0.950
1005	1.04	3.89	0.933
1001	0.96	3.91	0.917
997	0.89	3.92	0.900
994	0.82	3.94	0.883
990	0.72	3.96	0.867
986	0.70	3.98	0.833

Propylene glycol with 50% admixture

Antifrogen L				
Fluid temperature	Density	Kinematic viscosity	Specific heat capacity	Relative pressure loss
[°C]	$\rho$ [kg/m <sup>3</sup> ]	$\nu$ [mm <sup>2</sup> /s]	$c_p$ [kJ/kg·K]	$f_p$
-30	1072	202.20	3.37	3.958
-25	1070	128.58	3.39	3.473
-25	1070	128.58	3.39	3.473
-15	1067	54.94	3.43	2.748
-10	1065	37.78	3.44	2.480
-5	1062	26.94	3.46	2.261
0	1060	19.89	3.48	2.081
5	1057	15.13	3.50	1.932
10	1054	11.80	3.52	1.807
15	1051	9.37	3.53	1.70
20	1048	7.55	3.55	1.608
25	1045	6.13	3.57	1.526
30	1042	5.01	3.59	1.451
35	1038	4.12	3.60	1.383
40	1035	3.43	3.62	1.319
45	1031	2.88	3.64	1.258
50	1027	2.45	3.66	1.201
55	1024	2.12	3.67	1.147
60	1020	1.84	3.69	1.098
65	1016	1.62	3.71	1.052
70	1012	1.42	3.73	1.011
75	1008	1.25	3.75	0.975
80	1004	1.10	3.76	0.944
85	1000	0.98	3.78	0.919
90	996	0.87	3.80	0.90
95	992	0.80	3.82	0.884
100	988	0.75	3.85	0.872

Tyfocor L			
Density	Kinematic viscosity	Specific heat capacity	Relative pressure loss
$\rho$ [kg/m <sup>3</sup> ]	$\nu$ [mm <sup>2</sup> /s]	$c_p$ [kJ/kg·K]	$f_p$
1076	241	3.27	3.800
1074	128	3.29	3.200
1071	80.2	3.31	2.800
1068	52.3	3.33	2.533
1066	35.2	3.35	2.317
1063	24.5	3.37	2.100
1060	17.6	3.39	1.933
1057	13.0	3.41	1.800
1054	9.83	3.43	1.700
1051	7.64	3.46	1.600
1048	6.08	3.48	1.500
1045	4.94	3.50	1.417
1042	4.10	3.52	1.350
1038	3.46	3.54	1.283
1035	2.96	3.56	1.233
1032	2.58	3.58	1.183
1028	2.27	3.60	1.150
1025	2.02	3.62	1.117
1021	1.81	3.64	1.067
1018	1.64	3.66	1.033
1014	1.49	3.69	1.017
1010	1.36	3.71	0.983
1006	1.24	3.73	0.967
1003	1.14	3.75	0.950
999	1.04	3.77	0.917
995	0.94	3.79	0.900
991	0.85	3.81	0.883

APPENDIX

Vapor pressure and density of water at different temperatures

This table shows the vapour pressure  $p$  [bar] and the density  $\rho$  [kg/m<sup>3</sup>] of water at different temperatures  $t$  [°C]. The table also shows the absolute temperatures  $T$  [K].

$t$ [°C]	$T$ [K]	$p$ [bar]	$\rho$ [kg/m <sup>3</sup> ]	$t$ [°C]	$T$ [K]	$p$ [bar]	$\rho$ [kg/m <sup>3</sup> ]	$t$ [°C]	$T$ [K]	$p$ [bar]	$\rho$ [kg/m <sup>3</sup> ]
0	273.15	0.00611	999.8					138	411.15	3.414	927.6
1	274.15	0.00657	999.9	61	334.15	0.2086	982.6	140	413.15	3.614	925.8
2	275.15	0.00706	999.9	62	335.15	0.2184	982.1	145	418.15	4.155	921.4
3	276.15	0.00758	999.9	63	336.15	0.2286	981.6	150	423.15	4.760	916.8
4	277.15	0.00813	1000.0	64	337.15	0.2391	981.1				
5	278.15	0.00872	1000.0	65	338.15	0.2501	980.5	155	428.15	5.433	912.1
6	279.15	0.00935	1000.0	66	339.15	0.2615	979.9	160	433.15	6.181	907.3
7	280.15	0.01001	999.9	67	340.15	0.2733	979.3	165	438.15	7.008	902.4
8	281.15	0.01072	999.9	68	341.15	0.2856	978.8	170	443.15	7.920	897.3
9	282.15	0.01147	999.8	69	342.15	0.2984	978.2	175	448.15	8.924	892.1
10	283.15	0.01227	999.7	70	343.15	0.03116	977.7				
								180	453.15	10.027	886.9
11	284.15	0.01312	999.7	71	344.15	0.03253	977.7	185	458.15	11.233	881.5
12	285.15	0.01401	999.6	72	345.15	0.03396	976.5	190	463.15	12.551	876.0
13	286.15	0.01497	999.4	73	346.15	0.03542	976.0	195	468.15	13.987	876.4
14	287.15	0.01597	999.3	74	347.15	0.03696	975.3	200	473.15	15.50	864.7
15	288.15	0.01704	999.2	75	348.15	0.03855	974.8				
16	289.15	0.01817	999.0	76	349.15	0.04019	974.1	205	478.15	17.243	858.8
17	290.15	0.01936	998.8	77	350.15	0.04189	973.5	210	483.15	19.077	852.8
18	291.15	0.02062	998.7	78	351.15	0.04365	972.9	215	488.15	21.060	846.7
19	292.15	0.02196	999.5	79	352.15	0.04547	972.3	220	493.15	23.198	840.3
20	293.15	0.02397	998.3	80	353.15	0.04736	971.6	225	498.15	25.501	833.9
21	294.15	0.02485	998.1	81	354.15	0.4931	971.0	230	503.15	27.976	827.3
22	295.15	0.02642	997.8	82	355.15	0.5133	970.4	235	508.15	30.632	820.5
23	296.15	0.02808	997.6	83	356.15	0.5342	969.7	240	513.15	33.478	813.6
24	297.15	0.02982	997.4	84	357.15	0.5557	969.1	245	518.15	36.523	806.5
25	298.15	0.03166	997.1	85	358.15	0.5780	968.4	250	523.15	39.776	799.2
26	299.15	0.03360	996.8	86	359.15	0.6011	967.8	255	528.15	43.746	791.6
27	300.15	0.03564	996.6	87	360.15	0.6249	967.1				
28	301.15	0.03778	996.3	88	361.15	0.6495	966.5	260	533.15	46.943	783.9
29	302.15	0.04004	996.0	89	362.15	0.6749	965.8	265	538.15	50.877	775.9
30	303.15	0.04241	995.7	90	363.15	0.7011	965.2	270	543.15	55.058	767.8
								275	548.15	59.496	759.3
31	304.15	0.04491	995.4	91	364.15	0.7281	964.4	280	553.15	64.202	750.5
32	305.15	0.04753	995.1	92	365.15	0.7561	963.8				
33	306.15	0.05029	994.7	93	366.15	0.7849	963.0	285	558.15	69.186	741.5
34	307.15	0.05318	994.4	94	367.15	0.8146	962.4	290	563.15	74.461	732.1
35	308.15	0.05622	994.0	95	368.15	0.8453	961.6	295	568.15	80.037	722.3
36	309.15	0.05940	993.7	96	369.15	0.8769	961.0	300	573.15	85.927	712.2
37	310.15	0.06274	993.3	97	370.15	0.9094	960.2	305	578.15	92.144	701.7
38	311.15	0.06624	993.0	98	371.15	0.9430	959.6	310	583.15	98.700	690.6
39	312.15	0.06991	992.7	99	372.15	0.9776	958.6				
40	313.15	0.07375	992.3	100	373.15	1.0133	958.1	315	588.15	105.61	679.1



t [°C]	T [K]	p [bar]	ρ [kg/m <sup>3</sup> ]	t [°C]	T [K]	p [bar]	ρ [kg/m <sup>3</sup> ]	t [°C]	T [K]	p [bar]	ρ [kg/m <sup>3</sup> ]
41	314.15	0.07777	991.9	102	375.15	1.0878	956.7	320	593.15	112.89	666.9
42	315.15	0.09198	991.5	104	377.15	1.1668	955.2	325	598.15	120.56	646.1
43	316.15	0.08639	991.1	106	379.15	1.2507	953.7	330	603.15	128.63	640.4
44	317.15	0.09100	990.7	108	381.15	1.3390	952.2	340	613.15	146.05	610.2
45	318.15	0.09582	990.2	110	383.15	1.4327	950.7				
46	319.15	0.10086	989.8					350	623.15	165.35	574.3
47	320.15	0.10612	989.4	112	385.15	1.5316	949.1	360	633.15	186.75	527.5
48	321.15	0.11162	988.9	114	387.15	1.6362	947.6				
49	322.15	0.11736	988.4	116	389.15	1.7465	946.0	370	643.15	210.54	451.8
50	323.15	0.12335	988.0	118	391.15	1.8628	944.5	474.15	647.30	221.2	315.4
				120	393.15	1.9854	942.9				
51	324.15	0.12961	987.6								
52	325.15	0.13613	987.1	122	395.15	2.1145	941.2				
53	326.15	0.14293	986.6	124	397.15	2.2504	939.6				
54	327.15	0.15002	986.2	126	399.15	2.3933	937.9				
55	328.15	0.15741	985.7	128	401.15	2.5435	936.2				
56	329.15	0.16511	985.2	130	403.15	2.7013	934.6				
57	330.15	0.17313	984.6								
58	331.15	0.18147	984.2	132	405.15	2.8670	932.8				
59	332.15	0.19016	983.7	134	407.15	3.041	931.1				
60	333.15	0.19920	983.2	136	409.15	3.223	929.4				

## Further Reading

Paperback book of Heating + Air-conditioning Technology (Recknagel/Sprenger/Schramek), Oldenbourg-Industrieverlag, Essen 2006

Centrifugal pump (Gulich), Springer-Verlag, Heidelberg 2004

Paperback book of refrigerating technology (Pohlmann/iket, Hrsg.), C.F. Müller-Verlag, Heidelberg 2005

The cooling system engineer (Breidenbach), C.F. Müller-Verlag, Heidelberg 2003

# Seminars



Current information and dates for  
Wilo seminars can be found at:  
[www.wilo.com](http://www.wilo.com)

## Wilo seminars

The Wilo seminars will help you always keep your professional expertise up-to-date: with many training programs in the areas of heating, cooling, air conditioning, water supply as well as sewage disposal.

The seminars are specifically tailored to the requirements of your daily work routine. Our trainers have many years of experience in skilled craft firms and for this reason always teach seminars with a direct reference to daily practice.

The training centres in Dortmund and Oschersleben offer an optimal environment for modern learning at the highest level. Besides conference and meeting rooms, they have practically equipped method rooms: ideal for the handling-oriented training on pumps and system models.

The one-day events – including lunch – are free of charge for you. You will get a Wilo certificate after successfully participating in the seminar.

## Wilo-Brain

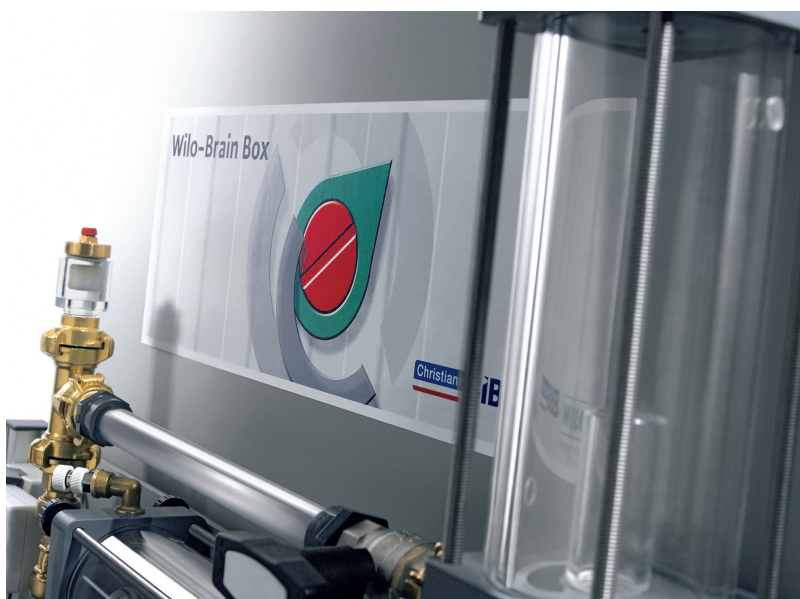

80 to 90 % of all customer complaints with regard to heating and secondary hot water circulation systems can be easily avoided: by designing/adjusting the system to be demand-oriented.

Wilo-Brain will help you to make your customers happier and to make your business more successful. Hereby, this isn't a product training program, but a general system training program spanning many manufacturers. Wilo-Brain utilizes existing knowledge, puts this in systematic context and offers brand new tips and tricks for installation and maintenance. Whether a hydraulic balancing of heating systems or hygiene protection in secondary hot water circulation: Wilo-Brain passes on expertise for noise-free, smooth system operation and long-term energy efficiency.

The system training programs take place in Wilo Brain Centres, industry-wide training centres for guilds, chambers and technical colleges all over Germany.

# Information material

## Basic knowledge



## Product catalogues



## Planning information



## System knowledge



*This information material can be ordered with the order forms on the following pages or you can order online at [www.wilo.de](http://www.wilo.de)*

**Fax/letter response**  
**0 18 05 F•A•X•W•I•L•O\***  
**0 18 05 3•2•9•9•4•5•6\***

(master copy)



WILO AG  
 Market Management  
 Nortkirchenstraße 100  
 44263 Dortmund  
 Germany

**Company address/Billing address**

---

Please send me:

*Basic knowledge*



Wilo Pump Manual

\_\_\_ copies

Stamp/signature

**Mailing address**

---

*Product catalogues*



Wilo-Compact  
 Skilled craftsmen catalogue  
 with product and planning  
 information

\_\_\_ copies

Company

Name

Street, no.

ZIP code/Town or city



Complete overview  
 Pumps and systems for build-  
 ing engineering, industry and  
 municipal water supply and  
 disposal

\_\_\_ copies

Telephone

Telefax

E-mail

*Planning Guides*



Sewage Technology

\_\_\_ copies

Cooling/air conditioning and  
 cooling technology

\_\_\_ copies

Rainwater utilisation technology

\_\_\_ copies

Internet

\*14 cents per minute from the German fixed line network

*Planning guide for refrigeration, air-conditioning and cooling technology 02/2007*

# Fax/letter response

## +49 7531 580185

(master copy)



Dr.-Ing. Paul Christiani GmbH & Co. KG  
 Technisches Institut für Aus-  
 und Weiterbildung  
 Hermann-Hesse-Weg 2  
 78464 Konstanz

Company address/Billing address

---

Stamp/signature

### System knowledge



Wilo-Brain Workbook  
 Optimisation of heating  
 systems  
 Order no.: 103936

per book € 45.00 plus tax.

\_\_\_ copies



Wilo-Brain Workbook  
 Optimisation of hot drinking  
 water circulation systems  
 Order no.: 71329

per book € 45.00 plus tax.

\_\_\_ copies

### Mailing address

---

Company

---

Name

---

Street, no.

---

ZIP code/Town or city

---

Telephone

---

Telefax

---

E-mail

---

Internet

---

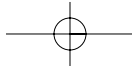
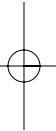
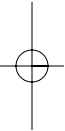
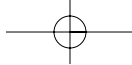

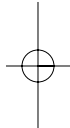
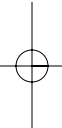
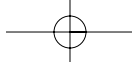

WILO AG has worked on the text in this document with great care. Still, errors cannot be ruled out. Publisher liability is excluded, regardless of the legal ground.

Editorial staff members:

Manfred Oraschewski, Joachim Scheiner, Stephan Thomas Schuster

Copyright 2007 by WILO AG, Dortmund

This work, including all its parts, is copyright protected. Any use outside the narrow limits of copyright law is illegal and liable to prosecution without the permission of WILO AG. This especially applies for duplications, translation, microfilms, other types of processing, as well as for the storing and processing in electronic systems. This also applies for taking individual figures and using excerpts from text.

1st Edition 2007

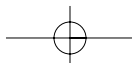



Pumpen Intelligenz.

WILO AG  
Nortkirchenstraße 100  
44263 Dortmund  
Germany  
T +49 231 4102-0  
F +49 231 4102-7363  
www.wilo.com

## Wilo – International (Subsidiaries)

### Austria

WILO HandelsGES. m.b.H.  
1230 Wien  
T +43 5 07507-0  
F +43 5 07507-42  
office@wilo.at

### Azerbaijan

WILO Caspian LLC  
1014 Baku  
T +994 12 4992386  
F +994 12 4992879  
info@wilo.az

### Belarus

WILO Bel OOO  
220035 Minsk  
T +375 17 2503393  
F +375 17 2503383  
wilobel@wilo.by

### Belgium

WILO SA/NV  
1083 Ganshoren  
T +32 2 4823333  
F +32 2 4823330  
info@wilo.be

### Bulgaria

WILO Bulgaria Ltd.  
1125 Sofia  
T +359 2 9701970  
F +359 2 9701979  
info@wilo.bg

### Canada

WILO Canada Inc.  
Calgary, Alberta T2A5L4  
T/F +1 403 2769456  
bill.lowe@wilo-na.com

### China

WILO SALMSON (Beijing)  
Pumps System Ltd.  
101300 Beijing  
T +86 10 80493900  
F +86 10 80493788  
wilobj@wilo.com.cn

### Croatia

WILO Hrvatska d.o.o.  
10090 Zagreb  
T +38 51 3430914  
F +38 51 3430930  
wilo-hrvatska@wilo.hr

### Czech Republic

WILO Praha s.r.o.  
25101 Cestlice  
T +420 234 098 711  
F +420 234 098 710  
info@wilo.cz

### Denmark

WILO Danmark A/S  
2690 Karlslunde  
T +45 70 253312  
F +45 70 253316  
wilo@wilo.dk

### Estonia

WILO Eesti OÜ  
12618 Tallinn  
T +372 6509780  
F +372 6509781  
info@wilo.ee

### Finland

WILO Finland OY  
02330 Espoo  
T +358 207401540  
F +358 207401549  
wilo@wilo.fi

### France

WILO S.A.S.  
78310 Coignières  
T +33 1 30050930  
F +33 1 34614959  
info@wilo.fr

### Great Britain

WILO (U.K.) Ltd.  
DE14 2WJ Burton-  
Upon-Trent  
T +44 1283 523000  
F +44 1283 523099  
sales@wilo.co.uk

### Greece

WILO Hellas AG  
14569 Anixi (Attika)  
T +302 10 6248300  
F +302 10 6248360  
wilo.info@wilo.gr

### Hungary

WILO Magyarország Kft  
2045 Törökbálint  
(Budapest)  
T +36 23 889500  
F +36 23 889599  
wilo@wilo.hu

### Ireland

WILO Engineering Ltd.  
Limerick  
T +353 61 227566  
F +353 61 229017  
sales@wilo.ie

### Italy

WILO Italia s.r.l.  
20068 Peschiera  
Borromeo (Milano)  
T +39 25538351  
F +39 255303374  
wilo.italia@wilo.it

### Kazakhstan

WILO Central Asia  
050002 Almaty  
T +7 3272 785961  
F +7 3272 785960  
in.pak@wilo.kz

### Korea

WILO Pumps Ltd.  
621-807 Gimhae  
Gyeongnam  
T +82 55 3405809  
F +82 55 3405885  
wilo@wilo.co.kr

### Latvia

WILO Baltic SIA  
1019 Riga  
T +371 7 145229  
F +371 7 145566  
mail@wilo.lv

### Lebanon

WILO SALMSON  
Lebanon  
12022030 El Metn  
T +961 4 722280  
F +961 4 722285  
wsl@cyberia.net.lb

### Lithuania

WILO Lietuva UAB  
03202 Vilnius  
T/F +370 2 236495  
mail@wilo.lt

### Montenegro

WILO Beograd d.o.o.  
11000 Beograd  
T +381 11 2850410  
F +381 11 2851278  
office@wilo.co.yu

### The Netherlands

WILO Nederland b.v.  
1948 RC Beverwijk  
T +31 251 220844  
F +31 251 225168  
info@wilo.nl

### Norway

WILO Norge AS  
0901 Oslo  
T +47 22 804570  
F +47 22 804590  
wilo@wilo.no

### Poland

WILO Polska Sp. z o.o.  
05-090 Raszyn  
T +48 22 7026161  
F +48 22 7026100  
wilo@wilo.pl

### Portugal

Bombas Wilo-Salmson  
Portugal Lda.  
4050-040 Porto  
T +351 22 2076900  
F +351 22 2001469  
bombas@wilo-salmson.pt

### Romania

WILO Romania s.r.l.  
041833 Bucharest  
T +40 21 4600612  
F +40 21 4600743  
wilo@wilo.ro

### Russia

WILO Rus ooo  
123592 Moscow  
T +7 495 7810690  
F +7 495 7810691  
wilo@orc.ru

### Serbia

WILO Beograd d.o.o.  
11000 Beograd  
T +381 11 2850410  
F +381 11 2851278  
office@wilo.co.yu

### Slovakia

WILO Slovakia s.r.o.  
82008 Bratislava 28  
T +421 2 45520122  
F +421 2 45246471  
wilo@wilo.sk

### Slovenia

WILO Adriatic d.o.o.  
1000 Ljubljana  
T +386 1 5838130  
F +386 1 5838138  
wilo.adriatic@wilo.si

### Spain

WILO Ibérica S.A.  
28806 Alcalá de Henares  
(Madrid)  
T +34 91 8797100  
F +34 91 8797101  
wilo.iberica@wilo.es

### Sweden

WILO Sverige AB  
35246 Växjö  
T +46 470 727600  
F +46 470 727644  
wilo@wilo.se

### Switzerland

EMB Pumpen AG  
4310 Rheinfelden  
T +41 61 8368020  
F +41 61 8368021  
info@emb-pumpen.ch

### Turkey

WILO Pompa Sistemleri  
San. ve Tic. A.Ş.  
34857 Istanbul  
T +90 216 6610203  
F +90 216 6610212  
wilo@wilo.com.tr

### Ukraine

WILO Ukraïna t.o.w.  
01033 Kiev  
T +38 044 2011870  
F +38 044 2011877  
wilo@wilo.ua

### USA

WILO-EMU LLC  
Thomasville, Georgia  
31758-7810  
T +1 229 584 0098  
F +1 229 584 0234  
terry.rouse@wilo-emu.com

### USA

WILO USA LLC  
Calgary, Alberta T2A5L4  
T/F +1 403 2769456  
bill.lowe@wilo-na.com

## Wilo – International (Representation offices)

### Bosnia and Herzegovina

71000 Sarajevo  
T +387 33 714510  
F +387 33 714511  
zeljko.cvjetkovic@wilo.ba

### Georgia

0177 Tbilisi  
T/F +995 32317813  
info@wilo.ge

### Macedonia

1000 Skopje  
T/F +389 2122058  
valerij.vojneski@wilo.com.mk

### Moldova

2012 Chisinau  
T/F +373 2 223501  
sergiu.zagorean@wilo.md

### Tajikistan

Dushanbe  
T +992 93 5554541

### Uzbekistan

100046 Taschkent  
T/F +998 71 1206774  
info@wilo.uz

January 2007