

Submittal Data Sheet

Wilo CO-Helix - NSF 61/372 Pressure Boosting System



CO-2 HELIX V190-03/2-1/20/VCE



Project:	
Engineer:	
Contractor:	
Submitted By:	Date:
Approved By:	Date:

Tag #	Model #	Flow	BOOST PSI	Min. Inlet PSI	HP/Pump	Phase	Voltage	RPM
	CO-2 HELIX V190-03/2-1/20/VCE				20			3600

CO-2 Helix 190-03/2

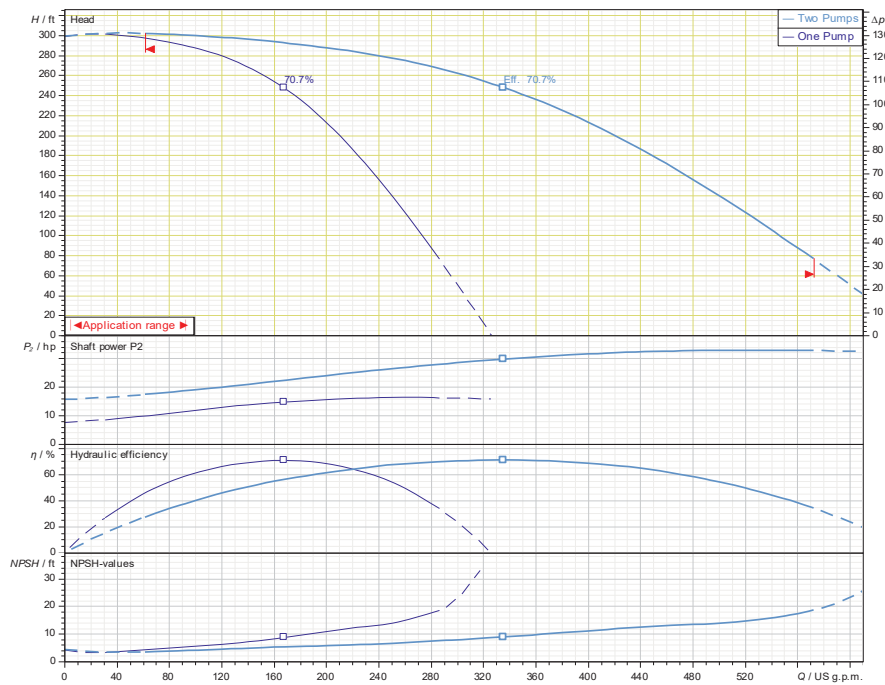

Applications

- Water Supply
- Agriculture
- Washing / Sprinkling Systems
- Pressure Boosting
- Cooling Circuits
- Condensate Return

Materials of Construction

Pump Volute	AISI304 stainless steel with ANSI flanges
Impeller	3D Laser welded AISI 304 Stainless Steel
Shaft	AISI304, AISI318 LN, or AISI431 Stainless Steel
Elastomers	EPDM
Isolation Valves	304 Stainless Steel Ball Valves
Suction/Discharge Manifolds	AISI304 Stainless Steel with Grooved System Connections
Check Valves	Wafer Style, 316 Stainless Steel internals, Non-slam, Plunger-type with EPDM seal/ Cast Iron Body
Mechanical Seal	Cartridge Seal: Sleeve AISI316L / Spring Clips AISI304
Pressure Transducers	316 Stainless Steel
Pressure Guages	304 Stainless Steel Housing with 316 Stainless Steel wetted parts
System base	Steel (S235JR)
Vibration Isolators	Neoprene, Height Adjustable

Technical Data - Operational Ranges

Liquid Temp Range	-4°F to +248°F (Min. 32 °F for Domestic Water)
Ambient Temp Range	+32°F to +104 °F
Max Inlet Pressure	145 PSI
Max System Pressure	232 PSI

Technical Data - Panel

Power Supply	208-230/460-3 or 575-3
Enclosure	NEMA 12 (3R Available Upon Request)
Standard	Meets UL 508A
Variable Frequency Drives	Danfoss FC-101

Technical Data - PLC

User Interface	7" Diagonal Color LCD Touchscreen
Display Resolution	800 x 480 Pixels
Supply Voltage	24VDC
Max. Current Consumption	320mA@24V
Number of Analog Inputs	9
Number of Analog Outputs	2
Number of Digital Inputs	18
Number of Digital Outputs	17
Onboard Communications	Modbus Protocol (Optional Gateways for BacNET, LonWorks, and CANbus)
Ethernet Port	RJ45 port capable of transmitting data 10/100Mbps
Additional Ports	2.0 USB Port; Micro-SD Port

Motor Data

Power Supply	208-230-3 or 460-3 or 575-3
Motor Enclosure	Totally Enclosed Fan Cooled (TEFC)
Motor Efficiency	Nema Premium Efficiency (IE3) - Meets NEMA 12-12 Rule
Enclosure Construction	Rolled Steel / Cast Iron
Motor Protection Index	IP54
Insulation Class	F

Approval Stamp

Submittal Data Sheet

Wilo CO-Helix - NSF 61/372 Pressure Boosting System



CO-2 HELIX V190-03/2-1/20/VCE

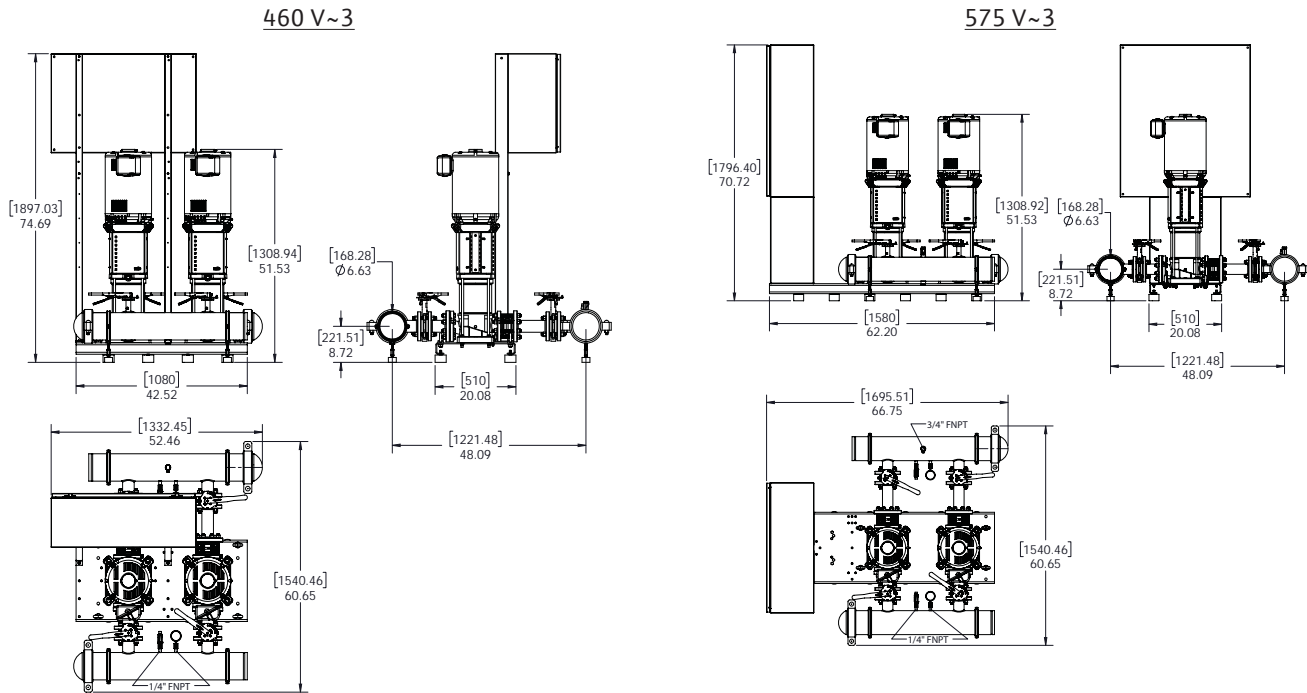

Special Note: All weights and dimensions are approximate and should not be used as exact rough-in dimensions

Dimensions and Weights

Model	Voltage (V)	Dimensions-inches							Individual Pump	Package	
		H (in)	W (in)	L (in)	System Header Size	Suction / Discharge Pump Size (300 Class ANSI)	Gauge Tap Size	Transducer Tap Size	Hydronumatic Tank Valve on Manifold (Plugged)	Pump Weight (lbs)	Package Weight (lbs)
CO-2 HELIX V190-03/2-1/20/VCE	460 V	74-3/4	52-1/2	60-5/8	6"	2-1/2"	1/4" FNPT	1/4" FNPT	3/4" MNPT x 3/4" FNPT	383	1,535
	575 V	70-3/4	66-3/4	60-5/8	GROOVED						

TEFC Motor Data

Model	P2 (HP)	Phase (-)	Voltage (V)	FLA (per pump) (A)	Pmax (PSI)
CO-2 HELIX V190-03/2-1/20/VCE	20	3	460/575	22.7/18.2	232