

Pioneering for You

**wilo**

## Wilo-IF-Module Stratos



- de** Einbau- und Betriebsanleitung
- en** Installation and operating instructions
- fr** Notice de montage et de mise en service
- es** Instrucciones de instalación y funcionamiento
- it** Istruzioni di montaggio, uso e manutenzione



Fig. 1:

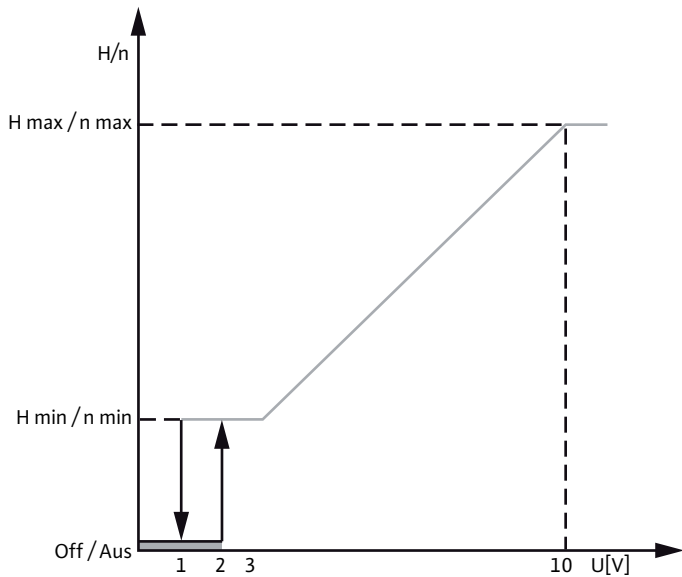
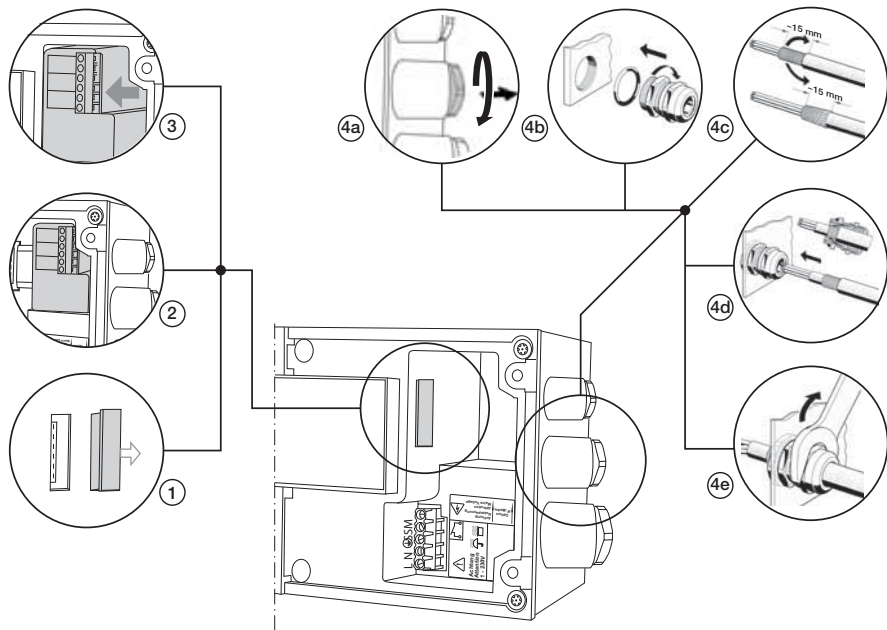

Fig. 2:



## 1 General

### 1.1 About this document

The language of the original operating instructions is German. All other languages of these instructions are translations of the original operating instructions.

These installation and operating instructions are an integral part of the product. They must be kept readily available at the place where the product is installed. Strict adherence to these instructions is a precondition for the proper use and correct operation of the product.

These installation and operating instructions correspond to the relevant version of the product and the underlying safety standards valid at the time of going to print.

## 2 Safety

These operating instructions contain basic information which must be adhered to during installation and operation. For this reason, these operating instructions must, without fail, be read by the service technician and the responsible operator before installation and commissioning.

It is not only the general safety instructions listed under the main point "safety" that must be adhered to but also the special safety instructions with danger symbols included under the following main points.

## 2.1 Indication of instructions in the operating instructions

Symbols:



General danger symbol



Danger due to electrical voltage



Note

Signal words:

**DANGER!**

Acutely dangerous situation.

Non-observance results in death or the most serious of injuries.

**WARNING!**

The user can suffer (serious) injuries. 'Warning' implies that (serious) injury to persons is probable if this information is disregarded.

**CAUTION!**

There is a risk of damage to the product/unit. 'Caution' implies that damage to the product is likely if this information is disregarded.

NOTE: Useful information on handling the product. It draws attention to possible problems.

## 2.2 Personnel qualifications

The installation, maintenance and repair personnel must have the necessary qualifications for this work.

## 2.3 Danger in the event of non-observance of the safety instructions

Non-observance of the safety instructions can result in risk of injury to persons and damage to product/unit. Non-observance of the safety instructions can result in the loss of any claims to damages.

In detail, non-observance can, for example, result in the following risks:

- Failure of important product/unit functions
- Failure of required maintenance and repair procedures
- Danger to persons from electrical, mechanical and bacteriological influences
- Property damage

## 2.4 Safety instructions for the operator

The existing directives for accident prevention must be adhered to.

Danger from electrical current must be eliminated. Local directives or general directives [e.g. IEC, VDE etc.] and those of local power supply companies must be adhered to.

This device is not intended to be operated by persons (including children) with impaired physical, sensory or mental capacities or lack of experience and/or lack of knowledge, except in cases where they are supervised by a person responsible for their safety or where they receive instructions from such a person as to how the device is to be operated.

Children must be kept under supervision in order to ensure that they do not play with the device.

## **2.5 Safety instructions for inspection and installation work**

The operator must ensure that all inspection and installation work is carried out by authorised and qualified personnel, who are sufficiently informed from their own detailed study of the operating instructions.

Work on the product/unit should only be carried out when it has been brought to a standstill. It is mandatory that the procedure described in the installation and operating instructions for shutting down the product/unit be complied with.

## **2.6 Unauthorised modification and manufacture of spare parts**

Modifications to the product are only permissible after consultation with the manufacturer. Original spare parts and accessories authorised by the manufacturer ensure safety. The use of other parts can nullify the liability from the results of their usage.

## **2.7 Improper use**

The operating reliability of the supplied product is only guaranteed if the product is used as intended in accordance with Section 4 of the operating instructions. The limit values must on no account fall under or exceed those specified in the catalogue/data sheet.



### 3 Transport and interim storage

Immediately check the IF-Module for any transit damage on arrival. If damage is found, the necessary procedure involving the forwarding agent must be taken within the specified period.



**CAUTION! Danger of damage to the IF-module!**

**Danger of damage due to incorrect handling during transportation and storage.**

**The unit must be protected from moisture, frost and mechanical damage during transport and interim storage.**

## 4 Intended use

The Stratos IF-Modules are designed for external control and operating status signalling of pumps in the Wilo-Stratos series.

The IF-Modules are not designed for proper safe deactivation of the pump.



**DANGER! Risk of injury and material damage!**

Using the control inputs for safety functions can lead to serious damage and injury.

## 5 Product information

### 5.1 Type key

Example: IF-Module Stratos SBM

Stratos IF-Module	
IF-Module	= Interface module
Stratos	= Suitable for these series
SBM	Model/function identifier: Ext. Off = external off Ext. Min = external minimum operation SBM = collective run signal Ext. Aus/SBM = external off and collective run signal DP = double pump interface only

## 5.2 Technical data

### General data

Terminal cross-section	1.5 mm <sup>2</sup> finely stranded
Safety in accordance with EN 60950	Up to mains voltage 230 V, configuration TN or TT

### Contact input

Version	SELV, isolated
Earth reference	Shared with control input 0-10 V
Off-load voltage	Max. 10 V
Loop current	Approx. 10 mA

### Contact output

Version	Potential-free
Load rating	30 V AC/60 V DC: 1 A AC1/DC1
Min. load	12 V DC, 10 mA

### Control input 0-10 V

Version	SELV, isolated
Earth reference	Shared with contact input
Voltage range	0-10 V
Input resistance	> 100 k $\Omega$
Accuracy	5 % absolute
Dielectric strength	24 V DC

## 5.2 Technical data

### Double pump interface (DP)

Interface	Wilo-specific, sustained short circuit protection, cannot be twisted out of place
Voltage	Max. 10 Vss
Frequency	Approx. 150 kHz
Cable length	Max. 3 m

### 5.3 Scope of delivery

- IF-Module
- Metal EMC cable gland Pg 9 (Pg 9 and Pg 7 in case of DP model)
- Installation and operating instructions
- Connecting cable for double pump interface
  - 2x2x0.22 mm<sup>2</sup> twisted and shielded pair (DP model)
  - 2x0.5 mm<sup>2</sup> light plastic-sheathed cable, 670 mm long (other models)

## 6 Description and function

### 6.1 Description of the IF-Modules

The Stratos IF-Modules expand the pump to include additional inputs and outputs and provide the connections for the double pump interface. The DP model plays a special role: it is used for through-connection of a BUS line for communication and provides the connections for the double pump interface.

## 6.2 Function

Function/ Stratos IF-Module	Ext. Off	Ext. Min	SBM	Ext. Off/ SBM	DP
Collective run signal output (SBM) as a potential-free NO contact	-	-	●	●	-
Input for potential-free NC contact with the function Ext. Min	-	●	-	-	-
Input for potential-free NC contact with the function Ext. Off	●	-	-	●	-
Control input 0-10 V Remote setpoint adjustment Remote speed adjustment	●	●	●	-	-
DP interface for dual pump management	●	●	●	●	●

**Ext. Off:** Input for potential-free NC contact.

- Contact closed: pump operates under auto control.
- Contact open: pump off.

**Ext. Min:** Input for potential-free NC contact.

- Contact closed: pump operates under auto control.
- Contact open: pump operates at a fixed minimum speed.

**SBM:** Output as potential-free NO contact.

- Contact closed: pump operates in the specified operating mode.
- Contact open: pump off.

**0-10 V:** Control input.

- Remote setpoint adjustment: differential pressure control is active on the pump. The setpoint for differential pressure is given by the analogue voltage 0-10 V (Fig. 1).
- Remote speed adjustment: differential pressure control is de-activated on the pump. The pump operates as an actuator with a constant speed, which is given by the voltage 0-10 V (Fig. 1).

**DP:** Interface between two pumps acting together as a double pump. The roles of the two pumps (master/slave) and the operating mode (main/standby or parallel operation) can be set.

## 7 Installation and electrical connection

Installation and electrical connection must be carried out in accordance with local regulations and only by qualified personnel.



**Warning! Risk of personal injury!**

The existing directives for accident prevention must be adhered to.



**Warning! Risk of fatal electrical shock!**

Danger from electrical current must be eliminated. Local directives or general directives [e.g. IEC, VDE etc.] and those of local power supply companies must be adhered to.

## 7.1 Installation

To ensure immunity in industrial environments (EN 61000-6-2) the data and control cables must be shielded cables and must be used with an EMC-compliant cable gland (included with the module).



### **WARNING! Danger of electric shock!**

**The pump should be electrically isolated and secured against unauthorised switch-on before beginning installation of the IF-Module.**

Installation steps in accordance with Fig. 2:

- Remove the lid of the pump's terminal box
- Remove the cover (1)
- Install the IF-Module in the pump's terminal box (2)
- Push the connection plug in all the way (3)
- Remove the existing Pg 9 screwed connections (4a)
- Install the accompanying metal EMC cable glands (4b)
- Strip and prepare the shield and the core wires (4c)
- Insert the cable (4d)
- Screw the cable gland into place (4e)

Electrical connection follows (see section below).

## 7.2 IF-Module Stratos DP

Installation steps in accordance with Fig. 2:

- Remove the lid of the pump's terminal box
- Remove the cover (1)
- Install the IF-Module in the pump's terminal box (2)
- Push the connection plug in all the way (3)
- Remove the existing Pg 7 / Pg 9 screwed connections (4a)
- Install the accompanying metal Pg 7 and Pg 9 EMC cable glands (4b)
- Strip and prepare the shield and the core wires of the accompanying cable 2x2x0.22 mm<sup>2</sup>, shielded pair (4c)
- Insert the cable (4d)
- Screw the cable gland into place (4e)

Electrical connection follows (see section below).

## 7.3 Electrical connection



**WARNING! Danger of electric shock!**

**Electrical connection must be carried out by an electrician authorised by the local electricity supply company and in accordance with the applicable local regulations [e.g. VDE regulations].**

- Carry out installation as described in the previous section
- Carry out electrical installation of the pump as specified in the relevant installation and operating instructions
- Check the technical specifications of the electric circuits being connected to ensure they are compatible with the electrical specifications of the IF-Module Terminal numbering as shown in Fig. 2, Pos. (3) from bottom to top



### 7.3.1 IF-Module Stratos Ext. Off

Terminal No.	Terminal
1	Ext. Off
2	Ext. Off
3	0-10 V
4	GND (for 0-10 V)
5	DP
6	DP

- Check that the Ext. Off wires are free of interference voltage
- Connect the Ext. Off wires to external devices
- Connect the 0-10 V wires (make sure polarity is correct)

### 7.3.2 IF-Module Stratos Ext. Min

Terminal No.	Terminal
1	Ext. Min
2	Ext. Min
3	0-10 V
4	GND (for 0-10 V)
5	DP
6	DP

- Check that the Ext. Min wires are free of interference voltage

- Connect the Ext. Min wires to external devices
- Connect the wires to 0-10 V (make sure polarity is correct)

### 7.3.3 IF-Module SBM

Terminal No.	Terminal
1	SBM
2	SBM
3	0-10 V
4	GND (for 0-10 V)
5	DP
6	DP

- Connect the SBM wires to external devices
- Connect the wires to 0-10 V (make sure polarity is correct)

### 7.3.4 IF-Module Stratos Ext. Off/SBM

Terminal No.	Terminal
1	Ext. Off
2	Ext. Off
3	SBM
4	SBM
5	DP
6	DP

- Check that the Ext. Off wires are free of interference voltage
- Connect the Ext. Off and SBM wires to external devices

### 7.3.5 IF-Module Stratos DP

Terminal No.	Terminal	Wire
1	BUS (joined with 3)	
2	BUS (joined with 4)	
3	BUS (joined with 1)	White (WH)
4	BUS (joined with 2)	Blue (BU)
5	DP	Red (RD)
6	DP	Black (BK)

- Connect the wires as shown in the table
- Connect the wires in the same order for the partner pump
- The BUS lines are connected in the partner pump, on terminals 1 and 2 (make sure polarity is correct)

### 7.4 Final work (all modules)

- Connect the DP wires to the partner pump (double pump only)
- Check the terminal box seal for any visible damage
- Close the terminal box lid with the screws provided so that the seal is tight all around
- Carry out commissioning / functional test in accordance with the following main section



## 8 Commissioning / functional test

The following sections describe testing the functioning of the inputs/outputs. It is recommended to test together with the connected system. The pump's installation and operating instructions are needed for some settings.

### 8.1 Ext. Off input

- Contact via Ext. Off terminals is closed
- Switch on the pump via the menu: symbol for "On" appears
- Contact via Ext. Off terminals is opened: pump switches off, symbol disappears

### 8.2 Ext. Min input

- Contact via Ext. Min terminals is closed
- Switch on the pump via the menu: symbol  appears, symbol  indicating setback operation is not visible (may need to increase setpoint/speed via menu or de-activate the "Auto Night" function)
- Contact via Ext. Min terminals is opened: symbol  appears "Pump is at min. speed"

### 8.3 0-10 V input

- Pump in "Manual control mode", symbol  visible
- Input voltage to 10 V: pump runs; the displayed speed is the maximum speed
- Input voltage to 2 V: pump runs; the displayed speed is the minimum speed
- Input voltage < 1 V: pump does not run
- Input voltage to 2 V: pump runs; the displayed speed is the minimum speed

### 8.4 SBM output

- Contact via Ext. Off terminals is closed (if installed)
- Switch on the pump via the menu: symbol  appears
- SBM contact is closed

- Switch off the pump via the menu: symbol changes to 
- SBM contact is opened

## 8.5 DP interface

- Set dual pump operation in accordance with the pump's installation and operating instructions: function is as described

## 9 Maintenance

The modules described in these instructions are maintenance-free.

## 10 Faults, causes and remedies

**Have repairs done by qualified skilled personnel only!**

**WARNING! Danger of electric shock!**

Any danger from electrical current should be ruled out.

- The pump should be electrically isolated and secured against unauthorised switch-on prior to any repair work.
- Damage to the mains connection cables should always be rectified by a qualified electrician only.

**WARNING! Risk of scalding!**

At high fluid temperatures and system pressures, allow the pump to cool down first and then depressurise the system.



Faults	Causes	Remedy
Pump does not start	Ext. Off contact not closed Voltage at 0-10 V input not sufficient	Check the external control
Pump stays at minimum speed	Ext. Min contact not closed Voltage at 0-10 V input not sufficient	Check the external control
Dual pump function does not work	Wiring damaged Incorrect menu setting	Check wiring Set pumps in accordance with manual

**If the operating fault cannot be remedied, please consult a specialist technician or the nearest Wilo after-sales service point or representative.**

## 11 Spare parts

Spare parts may be ordered via a local specialist retailer and/or Wilo customer service.

To avoid queries and incorrect orders, all data on the name plate should be submitted with each order.

## Wilo – International (Subsidiaries)

### Argentina

WILO SALMONSON  
Argentina S.A.  
C1295ABI Ciudad  
Autónoma de Buenos Aires  
T + 54 11 4361 5929  
info@salmonson.com.ar

### Australia

WILO Australia Pty Limited  
Murrarie, Queensland,  
4172  
T +61 7 3907 6900  
chris.dorron@wilo.com.au

### Austria

WILO Pumpen  
Österreich GmbH  
2351 Wiener Neustadt  
T +43 507 507-0  
office@wilo.at

### Azerbaijan

WILO Caspian LLC  
1014 Baku  
T +994 12 5962372  
info@wilo.az

### Belarus

WILO Bel OOO  
220035 Minsk  
T +375 17 2535363  
wilo@wilo.by

### Belgium

WILO SA/NV  
1083 Ganshoren  
T +32 2 4823333  
info@wilo.be

### Bulgaria

WILO Bulgaria Ltd.  
1125 Sofia  
T +359 2 9701970  
info@wilo.bg

### Brazil

WILO Brasil Ltda  
Jundiaí – São Paulo – Brasil  
ZIP Code: 13.213-105  
T + 55 11 2923 (WILO) 9456  
wilo@wilo-brasil.com.br

### Canada

WILO Canada Inc.  
Calgary, Alberta TZA 5L4  
T +1 403 2769456  
bil@wilo-wilo-na.com

### China

WILO China Ltd.  
101300 Beijing  
T +86 10 58041888  
wilo@wilo.com.cn

### Croatia

WILO Hrvatska d.o.o.  
10400 Šibenik  
T +38 511 3430914  
wilo-hrvatska@wilo.hr

### Czech Republic

WILO CS, s.r.o.  
25101 Cestlice  
T +420 234 098711  
info@wilo.cz

### Denmark

WILO Danmark A/S  
2690 Karlslunde  
T +45 70 253312  
wilo@wilo.dk

### Estonia

WILO Eesti OÜ  
12618 Tallinn  
T +372 6 509780  
info@wilo.ee

### Finland

WILO Finland OY  
02330 Espoo  
T +358 207401540  
wilo@wilo.fi

### France

WILO S.A.S.  
78390 Bois d'Arçay  
T +33 1 30059330  
info@wilo.fr

### Great Britain

WILO (U.K.) Ltd.  
Barton Upon Trent  
DE14 2WJ  
T +44 1283 523000  
sales@wilo.co.uk

### Greece

WILO Hellas AG  
14569 Anixi (Attika)  
T +30 10 6248300  
wilo.info@wilo.gr

### Hungary

WILO Magyarország Kft  
2045 Törökbalint  
(Budapest)  
T +36 23 889500  
wilo@wilo.hu

### India

WILO India Mather and Platt  
Pumps Ltd.  
Pune 411019  
T +91 20 271442100  
services@matherplatt.com

### Indonesia

WILO Pumps Indonesia  
Jakarta Selatan 12140  
T +62 21 7247676  
citrawilo@cbn.net.id

### Ireland

WILO Ireland  
Limerick  
T +353 61 227566  
sales@wilo.ie

### Italy

WILO Italia s.r.l.  
20068 Peschiera Borromeo  
(Milano)  
T +39 25538351  
wilo.italia@wilo.it

### Kazakhstan

WILO Central Asia  
050002 Almaty  
T +7 727 2785961  
info@wilo.kz

### Korea

WILO Pumps Ltd.  
618-220 Gangseo, Busan  
T +82 51 950 8000  
wilo@wilo.co.kr

### Latvia

WILO Baltic SIA  
1019 Riga  
T +371 6714-5229  
info@wilo.lv

### Lebanon

WILO LEBANON SARL  
Jdeideh 1202 2030  
Lebanon  
T +961 1 888910  
info@wilo.com.lb

### Lithuania

WILO Lietuva UAB  
03202 Vilnius  
T +370 5 2136495  
mail@wilo.lt

### Morocco

WILO MAROC SARL  
20600 CASABLANCA  
T +212 (0) 5 22 66 09  
24/28  
contact@wilo.ma

### The Netherlands

WILO Nederland b.v.  
1551 NA Westzaan  
T +31 88 9956 000  
info@wilo.nl

### Norway

WILO Norge AS  
0975 Oslo  
T +47 22 804570  
wilo@wilo.no

### Poland

WILO Polska Sp. z o.o.  
05-506 Lesznowola  
T +48 22 7026161  
wilo@wilo.pl

### Portugal

Bombas Wilo – Salmonson  
Portugal Lda.  
4050-040 Porto  
T +351 22 2080350  
bombas@wilo.pt

### Romania

WILO Romania s.r.l.  
077040 Com. Chiajna  
Jud. Ilfov  
T +40 21 3170164  
wilo@wilo.ro

### Russia

WILO Rus ooo  
123592 Moscow  
T +7 495 7810690  
wilo@wilo.ru

### Saudi Arabia

WILO ME – Riyadh  
Riyadh 11465  
T +966 1 4624430  
wshoula@watanianid.com

### Serbia and Montenegro

WILO Beograd d.o.o.  
11000 Beograd  
T +381 11 2851278  
office@wilo.rs

### Slovakia

WILO CS s.r.o., org. Zlozka  
83106 Bratislava  
T +421 2 33014511  
info@wilo.sk

### Slovenia

WILO Adriatic d.o.o.  
1000 Ljubljana  
T +386 1 5838130  
wilo.adriatic@wilo.si

### South Africa

Salmonson South Africa  
1610 Edenvale  
T +27 11 6082780  
errol.cornelius@salmonson.co.za

### Spain

WILO Ibérica S.A.  
28806 Alcalá de Henares  
(Madrid)  
T +34 91 8797100  
wilo.iberica@wilo.es

### Sweden

WILO Sverige AB  
35246 Växjö  
T +46 470 727600  
wilo@wilo.se

### Switzerland

EMB Pumpen AG  
4310 Rheinfelden  
T +41 61 83660-20  
info@emb-pumpen.ch

### Taiwan

WILO Taiwan Company Ltd.  
Sanzhong Dist., New Taipei  
City 24159  
T +886 2 2999 8676  
nelson.wu@wilo.com.tw

### Turkey

WILO Pompa Sistemleri  
San. ve Tic. A.Ş.  
34956 Istanbul  
T +90 216 2509400  
wilo@wilo.com.tr

### Ukraine

WILO Ukraina t.o.w.  
01033 Kiev  
T +38 044 201870  
wilo@wilo.ua

### United Arab Emirates

WILO Middle East FZE  
Jebel Ali Free Zone–South  
PO Box 162720 Dubai  
T +971 4 880 9177  
info@wilo.ae

### USA

WILO USA LLC  
Rosemont, IL 60018  
T +1 866 945 6872  
info@wilo-usa.com

### Vietnam

WILO Vietnam Co. Ltd.  
Ho Chi Minh City, Vietnam  
T +84 9 38109975  
nkminh@wilo.vn

# wilo

Pioneering for You

WILO SE  
Nortkirchenstraße 100  
D-44263 Dortmund  
Germany  
T +49(0)231 4102-0  
F +49(0)231 4102-7363  
wilo@wilo.com  
www.wilo.com