



Submittal Data Sheet

High-Efficiency Multistage Pumps



Helix EXCEL 50-02	
 CLASSIFIED UL US WATER QUALITY Certified to NSF/ANSI 61 	Project: _____ Engineer: _____ Contractor: _____ Submitted By: _____ Date: _____ Approved By: _____ Date: _____

Tag #	Model #	Flow	Head	Volute	Control Mode	HP	Phase	Voltage
	Helix Excel 50-02					1.5	3	460

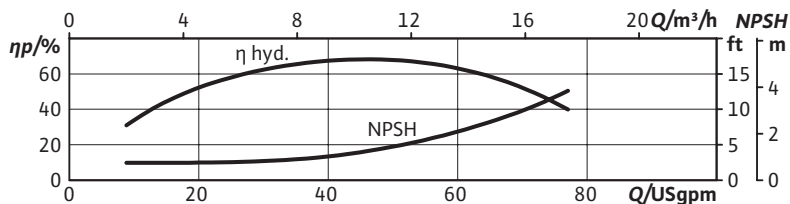
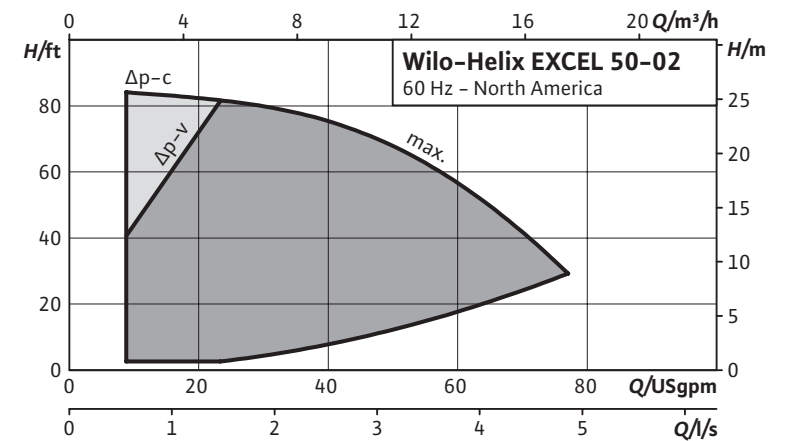
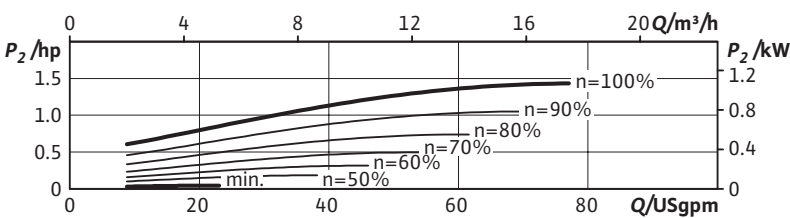
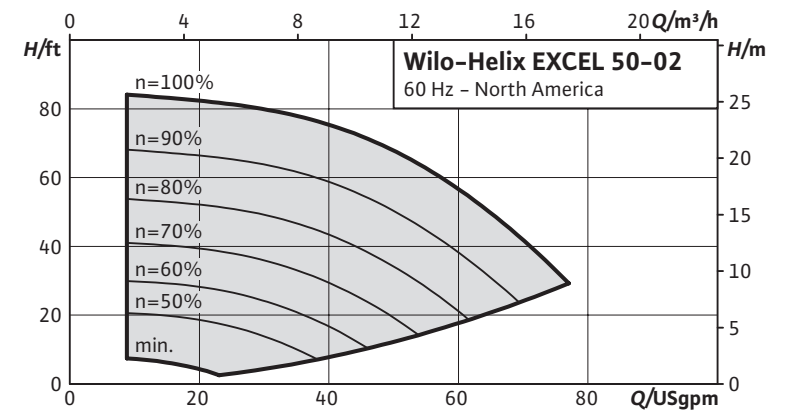

Technical Data	
Liquid Temp Range	-22°F to 284°F (-30°C to +120°C)
Fluid Compatibility	Water, up to 50/50 Water-Glycol
Max Operating Pressure	232.1/362.6 PSI
Mains Voltage	460V (±10%) 60Hz
Protection Class	IP 55, Class F Insulation
Ambient Temp Range	5°F to 104°F (-15°C to 40°C)
Ambient Humidity	< 90% without condensation

Materials of Construction		
Pump Volute	AISI 304L*	AISI 316L
Mechanical Seal	EPDM	FKM
Impellers Stage Housings Diffusers	AISI 304L	AISI 316L
Shaft	AISI 304L / AISI 318 LN	AISI 316L / AISI 318LN
O-ring for mechanical seal	EPDM (FKM gasket on request)	EPDM (FKM gasket on request)
Sleeve under the mechanical seal	AISI 316L	AISI 316L

*304 pump volutes are NSF 61 certified

IR Module Selection	
Select	Module
<input type="checkbox"/>	BACnet / Dual Pump
<input type="checkbox"/>	LONworks / Dual Pump
<input type="checkbox"/>	MODBus
<input type="checkbox"/>	None

Applications	
• Water Supply	• Pressure Boosting
• Boiler Feed	• Cooling Systems
• Pressure washing	• Irrigation

Submittal Data Sheet

High-Efficiency Multistage Pumps



Helix EXCEL 50-02 Dimensions & Weights

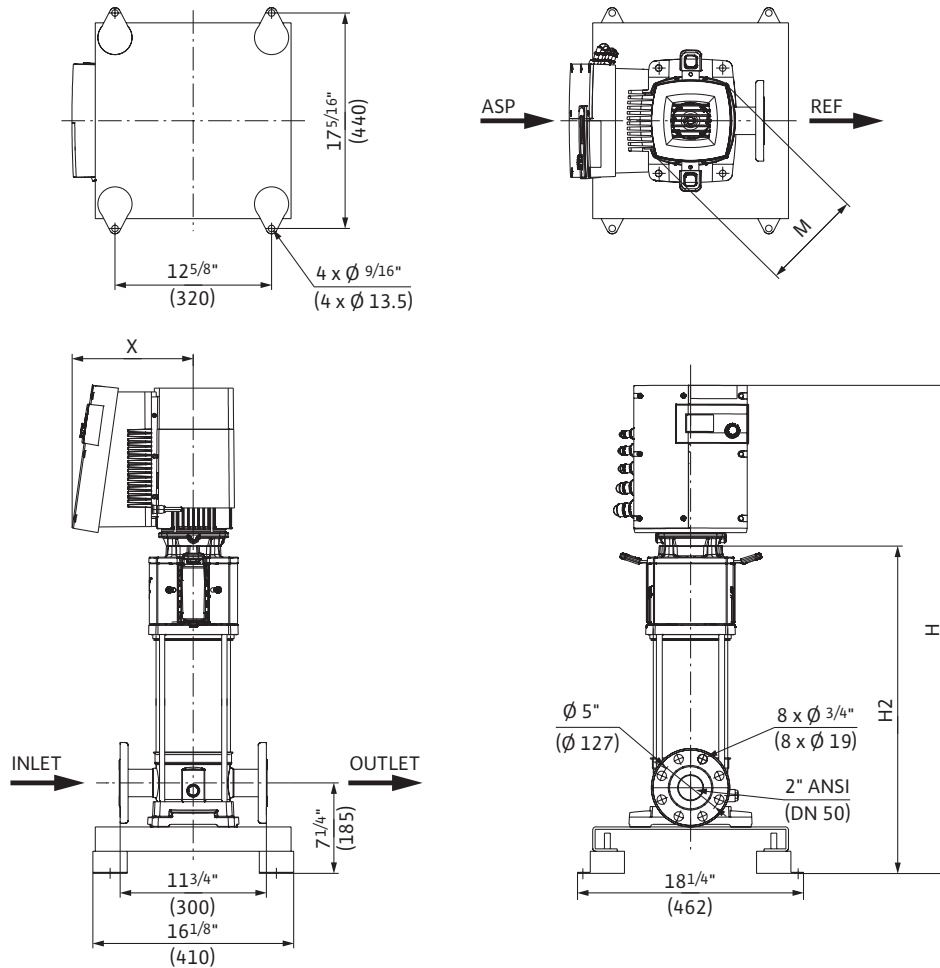

Dimensions and Weights

Model	Dimensions – Inches (mm)				Weight lbs (kg)
	H	H2	ØM	X	
Helix EXCEL 50-02	33 ^{1/16}	20 ^{3/16}	8 ^{3/8}	9 ^{3/4}	110.2
	(840)	(512)	(206)	(248)	(50)

EC Motor Data (Single Motor Operation)

Model	P ₂ Rated	Phase	Voltage	FLA	Efficiency
	hp	[~]	[V]	[A]	η _m 100%
Helix EXCEL 50-02	1.5	3	460 (±10%)	1.76	92.0

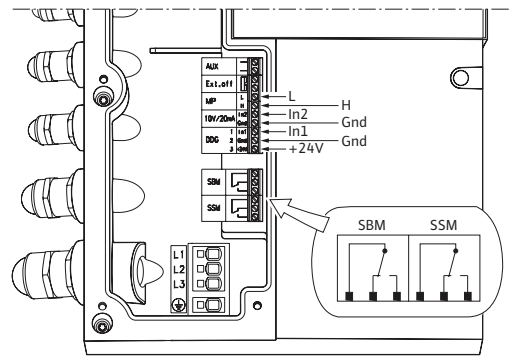

WILO USA LLC

Tel: (888) 945-6872 Web: www.wilo-usa.com
 Fax: (888) 945-6873 Email: info@wilo-usa.com

WILO Canada Inc.

Tel: (866) 945-6236 Web: www.wilo-canada.com
 Fax: (403) 277-9456 Email: info@wilo-canada.com

WILO Mexico

Tel: +52 55 5586 3209 Web: www.wilo-mexico.com.mx
 Fax: +52 1 55 5413 4165 Email: info@wilo.com.mx