

Pioneering for You

wilo

*Pompe in-line a motore ventilato elettroniche*

## VeroLine IP-E e DP-E, CronoLine IL-E e DL-E

Elettropompe elettroniche per applicazioni in impianti di riscaldamento, condizionamento e refrigerazione



APPLIES TO  
EUROPEAN  
DIRECTIVE  
FOR ENERGY  
RELATED  
PRODUCTS

**Siamo a vostra disposizione in tutto il mondo.**

Fin dal 1872 Wilo sviluppa da idee astratte nuove soluzioni concrete che diventano il riferimento tecnologico del settore. Il fondatore dell'azienda, Louis Opländer, con la sua attività nello sviluppo di impianti di distillazione cercò nuove soluzioni nella movimentazione dell'acqua e il trasferimento del calore. Il risultato dei suoi studi fu un enorme successo che portò nel 1928 il figlio Wilhelm Opländer alla progettazione e alla produzione del primo acceleratore per impianti di riscaldamento che ne rivoluzionò la tecnica impiantistica.

Nel 2001 "Wilo-Stratos" è stata la prima pompa a rotore bagnato ad alta efficienza. Oggi "Wilo-SiBoost Smart" il primo booster equipaggiato con elettropompe multistadio e motori elettrici trifase a magneti permanenti, suggerisce nuovi parametri di efficienza energetica anche per gli impianti di pressurizzazione idrica. Wilo mantiene anche oggi la sua attitudine alla ricerca, proponendo servizi e soluzioni all'avanguardia.

Oggi WILO SE è una società Europea, con sede a Dortmund, ed è un'azienda leader nel mondo per la produzione di pompe e sistemi di pompaggio per tutte le applicazioni. Con 16 siti produttivi, più di 60 filiali e circa 7.500 dipendenti, Wilo è presente in oltre 70 paesi nel mondo. L'obiettivo principale dell'azienda è soddisfare ogni giorno e in modo professionale le richieste dei clienti, fornendo loro soluzioni su misura, prodotti affidabili ad alta efficienza e servizi innovativi per la gestione degli impianti più complessi. Wilo è il partner di riferimento in tutti i segmenti di mercato quali: "Building Services", "Industry" e "Water Management".

Wilo propone una gamma completa di prodotti per tutte le applicazioni in impianti di: riscaldamento, condizionamento, refrigerazione, pressurizzazione idrica, drenaggio e fognatura, dal più piccolo circolatore per le abitazioni monofamiliari ai grandi sistemi per il raffreddamento dell'acqua nelle centrali elettriche.

È questo ciò che intendiamo con **Pioneering for You.**





## Qualità, alta efficienza, sicurezza per il futuro

### Le nostre prestazioni per i progettisti

**Wilo** ha l'obiettivo di accompagnare il progettista nella sua attività quotidiana, di supportarlo in modo mirato nella sua professione. Assistenza tecnica, supporto alla selezione e alla scelta, innovazione tecnologica ed elevatissimi standard di qualità, contribuiscono alla realizzazione dei Vostri progetti.

**Wilo** si propone come unico partner per la realizzazione dei Vostri progetti in impianti per l'alimentazione idrica e lo smaltimento delle acque reflue. Scegliete la qualità di Wilo, per tutte le applicazioni, la nostra proposta di sistemi per installazioni speciali, come ad esempio impianti di pressurizzazione per aree isolate senza collegamento alla rete idrica pubblica, impianti di sollevamento delle acque reflue in aree agricole isolate o con alti livelli dell'acqua freatica.

La nostra offerta di prodotti è strutturata in modo chiaro e sistematico, proponiamo pompe e sistemi completi o soluzioni modulari e personalizzate, per soddisfare le esigenze specifiche dei Vostri progetti.

Per Wilo efficienza e sostenibilità non sono solo slogan, ma obiettivi dichiarati. Le nostre pompe soddisfano i massimi valori di efficienza, i nostri standard produttivi prevedono la massima affidabilità.

Offrite ai vostri clienti soluzioni a lungo termine, che si distinguono per la loro affidabilità e sicurezza di funzionamento.

#### **Il Catalogo CAD on-line:**

Libreria cad 2D e 3D per accedere velocemente ai dati dimensionali dei nostri prodotti

#### **Il Catalogo dei prodotti on-line:**

da [productfinder.wilo.com](http://productfinder.wilo.com) si accede a tutte le informazioni sui prodotti con i relativi campi di applicazione e tutti i dettagli tecnici.

#### **Il software di selezione e scelta delle pompe**

##### **Wilo-Select:**

su [www.wilo-select.com](http://www.wilo-select.com) si può selezionare in pochi secondi la pompa adatta alla vostra installazione, corredata da tutte le informazioni tecniche

## Panoramica della serie

## Serie costruttiva

## Wilo-VeroLine-IP-E

## Wilo-VeroTwin-DP-E

Foto del prodotto



Campo prestazioni

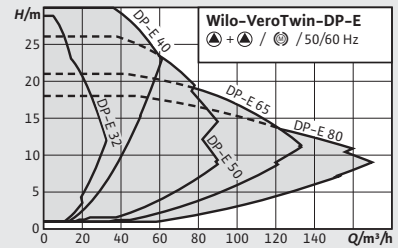
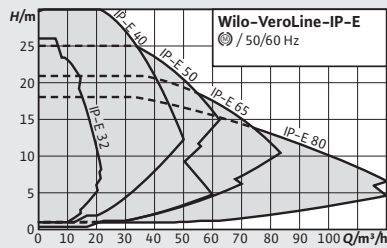

Impiego

Pompaggio di acqua di riscaldamento (secondo VDI 2035), acqua fredda e miscele di acqua/glicole senza sostanze abrasive negli impianti di riscaldamento, condizionamento e refrigerazione.

Pompaggio di acqua di riscaldamento (secondo VDI 2035), acqua fredda e miscele di acqua/glicole senza sostanze abrasive negli impianti di riscaldamento, condizionamento e refrigerazione.

Tipo

Pompa singola a motore ventilato regolata elettronicamente con costruzione inline, attacco flangiato e adattamento automatico delle prestazioni

Pompa doppia a motore ventilato regolata elettronicamente con costruzione inline, attacco flangiato e adattamento automatico delle prestazioni

 $Q_{max}$ 120 m<sup>3</sup>/h170 m<sup>3</sup>/h $H_{max}$ 

30 m

30 m

Particolarità/  
vantaggi del  
prodotto

- Risparmio di energia grazie all'adattamento elettronico delle prestazioni integrato
- Porte di comunicazione opzionali per la comunicazione bus mediante moduli IF innestabili
- Tecnologia del pulsante rosso e display per un semplice utilizzo
- Management integrato pompa doppia
- Protezione integrale del motore (sonda a termistore) con elettronica di sgancio

- Risparmio di energia grazie all'adattamento elettronico delle prestazioni integrato
- Porte di comunicazione opzionali per la comunicazione bus mediante moduli IF innestabili
- Tecnologia del pulsante rosso e display per un semplice utilizzo
- Management integrato pompa doppia
- Protezione integrale del motore (sonda a termistore) con elettronica di sgancio

Ulteriori  
informazioni

Informazione serie da pagina 6  
Catalogo Wilo online su [www.wilo.it](http://www.wilo.it)

Informazione serie da pagina 22  
Catalogo Wilo online su [www.wilo.it](http://www.wilo.it)

Panoramica della serie

Serie costruttiva

Wilo-CronoLine-IL-E

Wilo-CronoTwin-DL-E

Foto del prodotto



Campo prestazioni

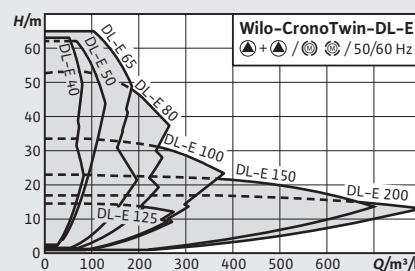
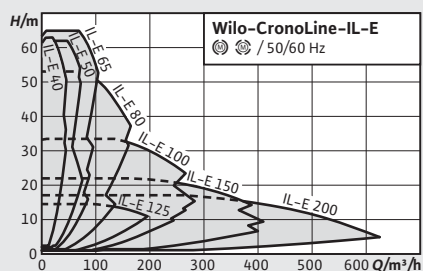

Impiego

Pompaggio di acqua di riscaldamento (secondo VDI 2035), acqua fredda e miscele di acqua/glicole senza sostanze abrasive negli impianti di riscaldamento, condizionamento e refrigerazione.

Pompaggio di acqua di riscaldamento (secondo VDI 2035), acqua fredda e miscele di acqua/glicole senza sostanze abrasive negli impianti di riscaldamento, condizionamento e refrigerazione.

Tipo

Pompa singola a motore ventilato regolata elettronicamente con costruzione inline, attacco flangiato e adattamento automatico delle prestazioni

Pompa doppia a motore ventilato regolata elettronicamente con costruzione inline, attacco flangiato e adattamento automatico delle prestazioni

$Q_{max}$

640 m<sup>3</sup>/h

800 m<sup>3</sup>/h

$H_{max}$

65 m

75 m

Particolarità/vantaggi del prodotto

- Risparmio di energia grazie all'adattamento elettronico delle prestazioni integrato
- Porte di comunicazione opzionali per la comunicazione bus mediante moduli IF innestabili
- Tecnologia del pulsante rosso e display per un semplice utilizzo
- Management integrato pompa doppia
- Protezione integrale del motore (sonda a termistore) con elettronica di sgancio

- Risparmio di energia grazie all'adattamento elettronico delle prestazioni integrato
- Tecnologia del pulsante rosso e display per un semplice utilizzo
- Differenti modi di funzionamento: funzionamento principale/di riserva e funzionamento in parallelo
- Comportamento in caso di errore configurabile per l'uso con applicazioni di riscaldamento e condizionamento
- Protezione integrale del motore (sonda a termistore) con elettronica di sgancio

Ulteriori informazioni

Informazione serie da pagina 50  
Catalogo Wilo online su [www.wilo.it](http://www.wilo.it)

Informazione serie da pagina 78  
Catalogo Wilo online su [www.wilo.it](http://www.wilo.it)

Riscaldamento, condizionamento e refrigerazione

# Wilo-VeroLine IP-E

Pompa singola a motore ventilato regolata elettronicamente

Per impianti di riscaldamento, condizionamento e refrigerazione commerciali ed industriali.

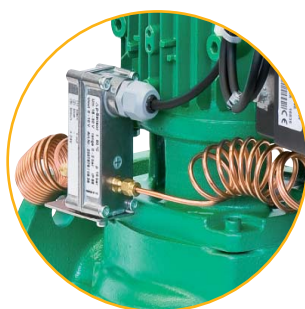

## Esecuzione

Pompe singole complete di trasduttore di pressione differenziale



## Efficienza

Motore elettrico in classe di efficienza IE4



## Idraulica

Idraulica ad alta efficienza Indice MEI 0,4

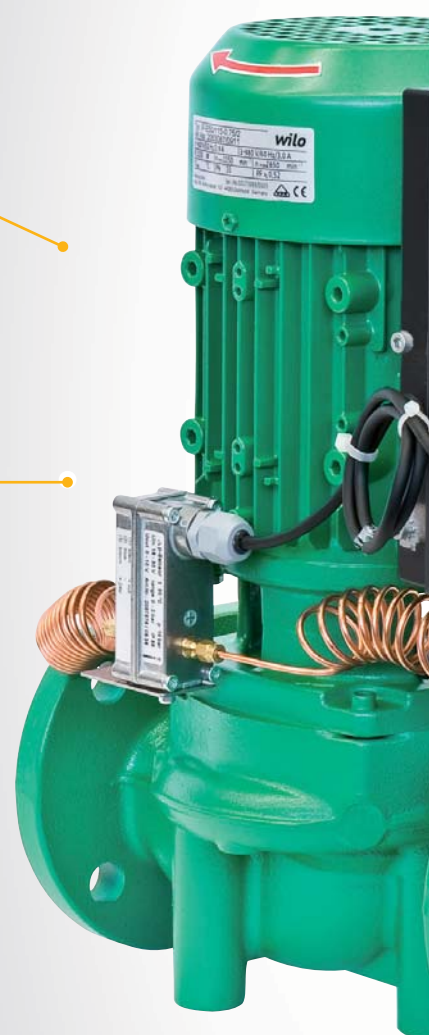

Per maggiori informazioni sui prodotti:  
[www.wilo.it](http://www.wilo.it)



### Focus

- Efficienza idraulica  $MEI=0,4$   
(secondo Direttiva ErP Regolamento CE n.547/2012)
- Efficienza motore IE4 (secondo IEC TS 60034-31 Ed.1)

### Vantaggi

- Campo di regolazione fino a tre volte maggiore delle pompe tradizionali regolate elettronicamente
- Con le interfacce seriali WILO-IF si integra con qualsiasi sistema di automazione degli edifici (BMS)

### In evidenza

Il display LCD di grandi dimensioni permette di visualizzare rapidamente i dati di SET della pompa.



### Tecnologia

La tecnologia 'pulsante rosso' rende la regolazione e l'installazione della pompa semplice e rapida.



### Installazione

I moduli WILO-IF permettono la connessione a tutte le reti di Building Management System.





Range Upgrade



## Wilo-VeroLine-IP-E



### Chiave di lettura

Esempio	<b>IP-E 40/160-4/2-R1</b>
<b>IP-E</b>	Pompa Singola inline con regolazione elettronica
<b>40</b>	Diametro nominale DN della bocca
<b>160</b>	Diametro nominale della girante
<b>4</b>	Potenza nominale del motore P <sub>2</sub> in kW
<b>2</b>	Numero poli
<b>R1</b>	Versione senza sensore di pressione

### Particolarità/vantaggi del prodotto

- Motore elettrico IE4
- Risparmio energetico grazie alla regolazione della velocità integrata
- WILO-Moduli-IF opzionale per l'integrazione in sistemi di building automation
- Tecnologia del pulsante rosso e display per un semplice utilizzo
- Management integrato pompa doppia
- Protezione integrale del motore

### Dati tecnici

Indice di efficienza minimo (MEI)	≥ 0,4
<b>Fluidi consentiti (altri fluidi su richiesta)</b>	
Acqua riscaldamento (secondo VDI 2035)	Sì
Miscele acqua/glicole (con 20-40 % vol. di glicole e temperatura fluido ≤ 40 °C)	Sì
Acqua fredda e refrigerata	Sì
Olio diatermico	Versione speciale
<b>Campo d'applicazione consentito</b>	
Campo di temperatura con una temperatura ambiente max. di +40°C	-20...+120 °C (a seconda del fluido di pompaggio)
Pressione nominale PN	10 bar
<b>Alimentazione elettrica</b>	
Alimentazione rete	3~440V ±10%, 50/60 Hz 3~400V ±10%, 50/60 Hz 3~380V -5%/+10%, 50/60 Hz

### Dati tecnici

<b>Motore/elettronica</b>	
Indice di efficienza motore elettrico	IE4
Protezione integrale del motore	Sì
Grado protezione	IP 55
Classe isolamento	F
Compatibilità elettromagnetica-Emissione	EN 61800-3
Compatibilità elettromagnetica-Immunità	EN 61800-3
<b>Materiali</b>	
Corpo pompa	EN-GJL-250
Lanterna	EN-GJL-250
Girante	PPO-GF30
Albero della pompa	1.4021 [AISI420]
Tenuta meccanica	AQEGG
Altre tenute meccaniche	su richiesta



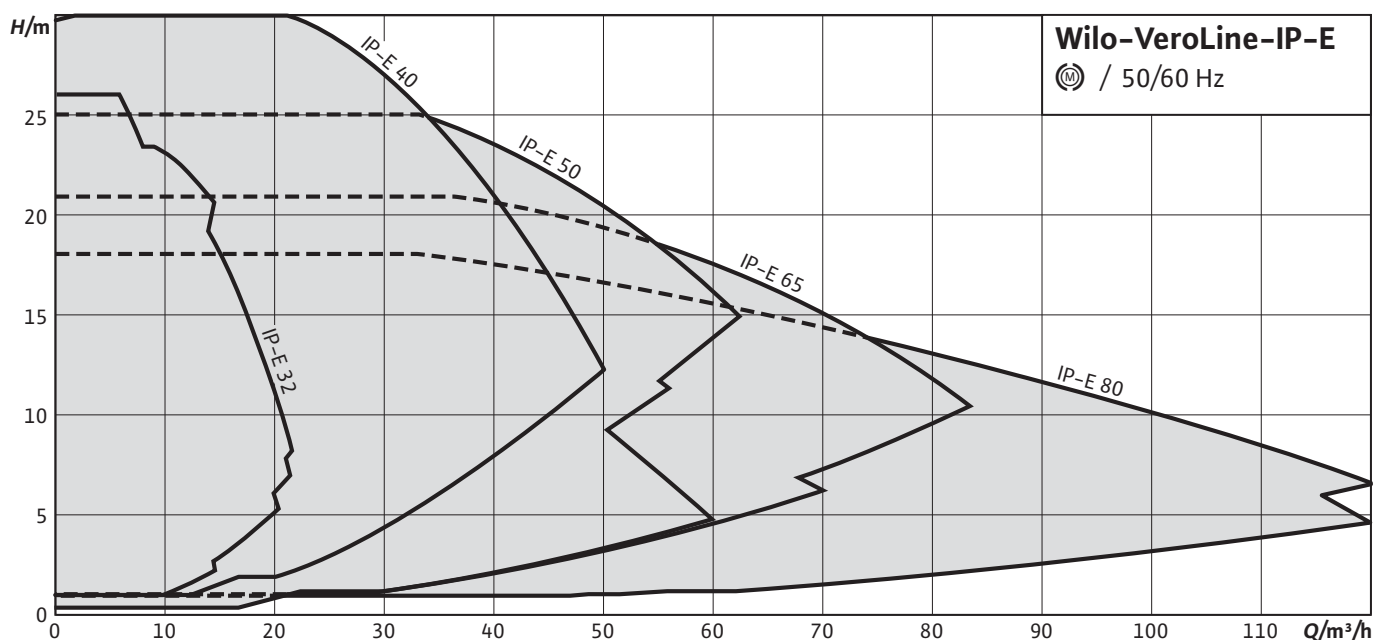

### Equipaggiamento/funzionamento

#### Modi di funzionamento

- $\Delta p$ -c per pressione differenziale costante
- $\Delta p$ -v per pressione differenziale variabile
- Controllo PID
- Funzionamento come servomotore ( $n = \text{costante}$ )

#### Livello di comando

- Pulsante rosso e display

#### Funzioni manuali

- Impostazione pompa on/off
- Impostazione del modo funzionamento
- Configurazione di tutti i parametri di esercizio
- Impostazione del numero di giri

#### Funzioni di comando esterne

- Ingresso di comando "prioritario Off"
- Ingresso di comando "scambio pompa" (solo con funzionamento a pompa doppia)
- Ingresso analogico per funzionamento come servomotore (DDC) e regolazione a distanza del valore di consegna:
  - 0–10 V
  - 2–10 V
  - 0–20 mA
  - 4–20 mA
- Ingresso analogico per segnale diretto dal sensore di pressione:
  - 0–10 V
  - 2–10 V
  - 0–20 mA
  - 4–20 m

#### Funzioni di segnalazione e visualizzazione

- Segnalazione cumulativa di blocco SSM
- Segnalazione cumulativa di funzionamento SBM

#### Scambio dati

- Porta di comunicazione a infrarossi per lo scambio dati senza fili con monitor IR o WILO-IR STICK
- Vano per innesto di moduli IF Wilo (Modbus, BACnet, CAN, PLR, LON) per interfaccia al sistema di automazione degli edifici (BMS)

#### Funzioni di sicurezza

- Protezione integrale del motore con elettronica di sgancio integrata
- Blocco accesso (regolazione)

#### Management pompa doppia (2 pompe singole)

- Funzionamento principale/di riserva scambio pompa dopo 24 ore di funzionamento (o eventuale anomalia ad una pompa)
- Funzione pompa doppia (somma di portata) punto di funzionamento ottimizzato al migliore rendimento

#### Opzioni

- Versione ...-R1 senza trasduttore di pressione differenziale
- Variante ...-H5 con corpo PN16
- Variante ...-S1/-S2 con tenuta meccanica speciale

#### Accessori

- 3 mensole con materiale di fissaggio per montaggio a basamento
- Monitor IR, WILO-IR STICK
- Modulo IF PLR per collegamento a PLR/convertitore porta di comunicazione
- Modulo IF LON per collegamento alla rete LONWORKS
- Modulo IF BACnet
- Modulo IF Modbus
- Modulo IF CAN
- Quadri elettrici di controllo VR-HVAC
- Quadri elettrici di controllo CCe-HVAC
- Quadri elettrici di controllo SCe-HVAC
- Trasduttore differenza di pressione (DDG)

Curve caratteristiche

Veroline-IP-E 32/95-0,55/2

Curve caratteristiche

Veroline-IP-E 32/105-0,75/2

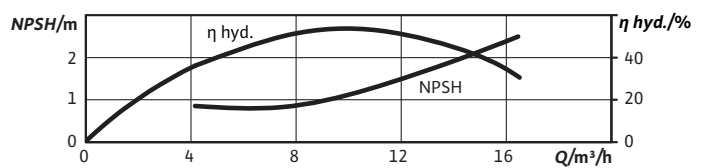
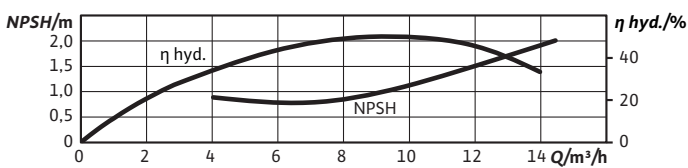
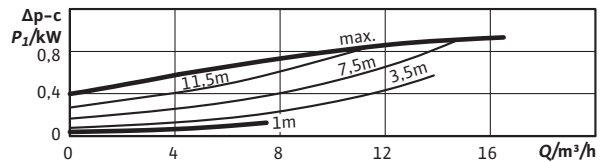
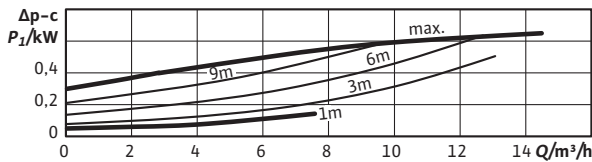
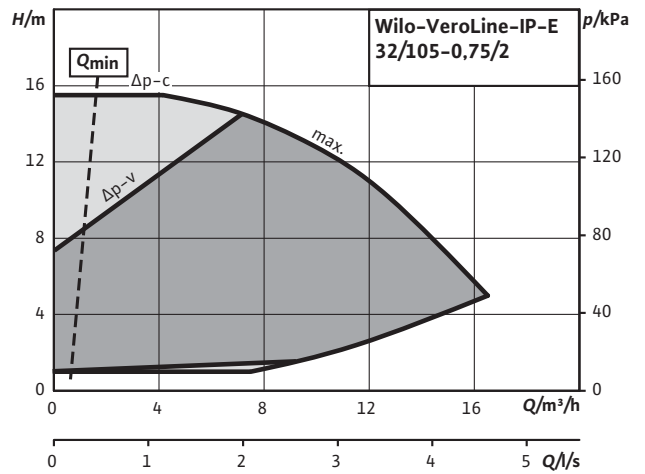
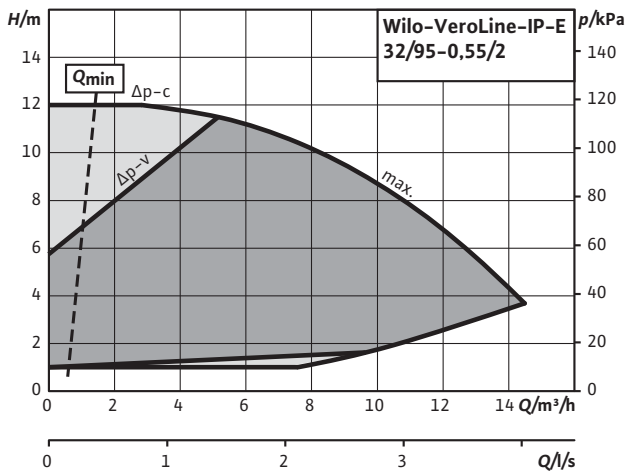
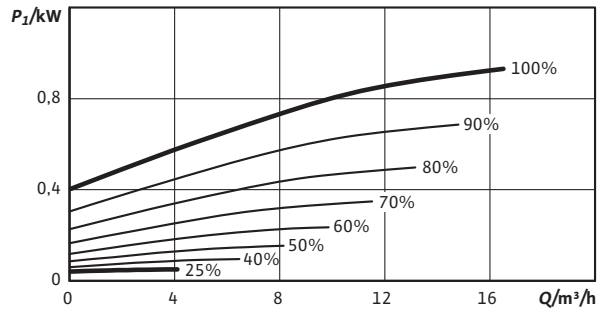
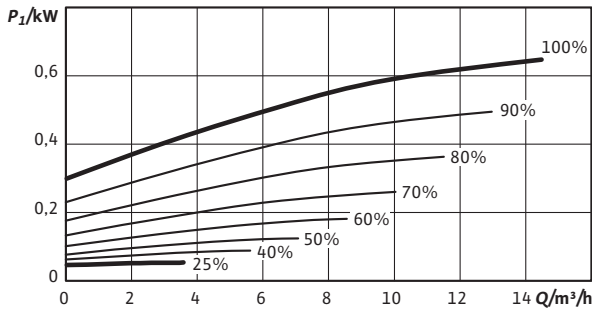
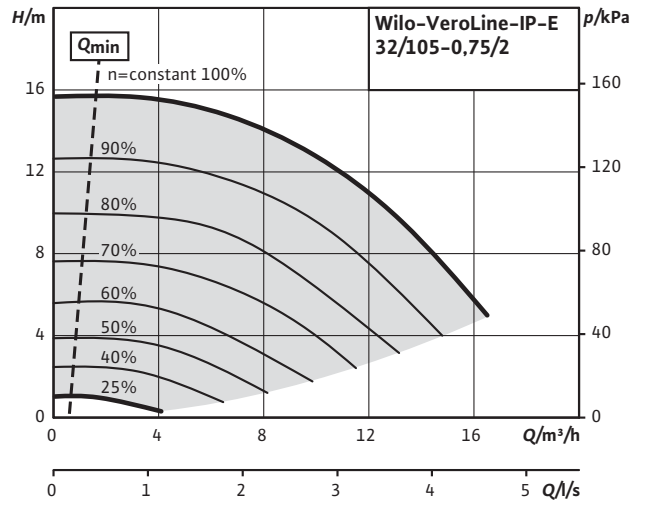
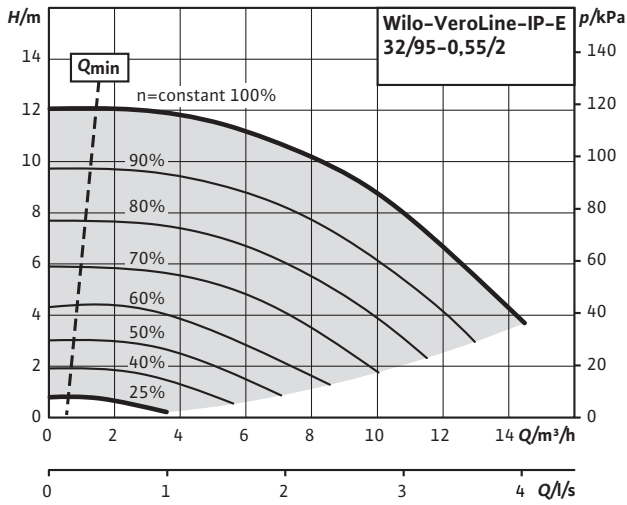

Curve caratteristiche

Veroline-IP-E 32/125-1,1/2

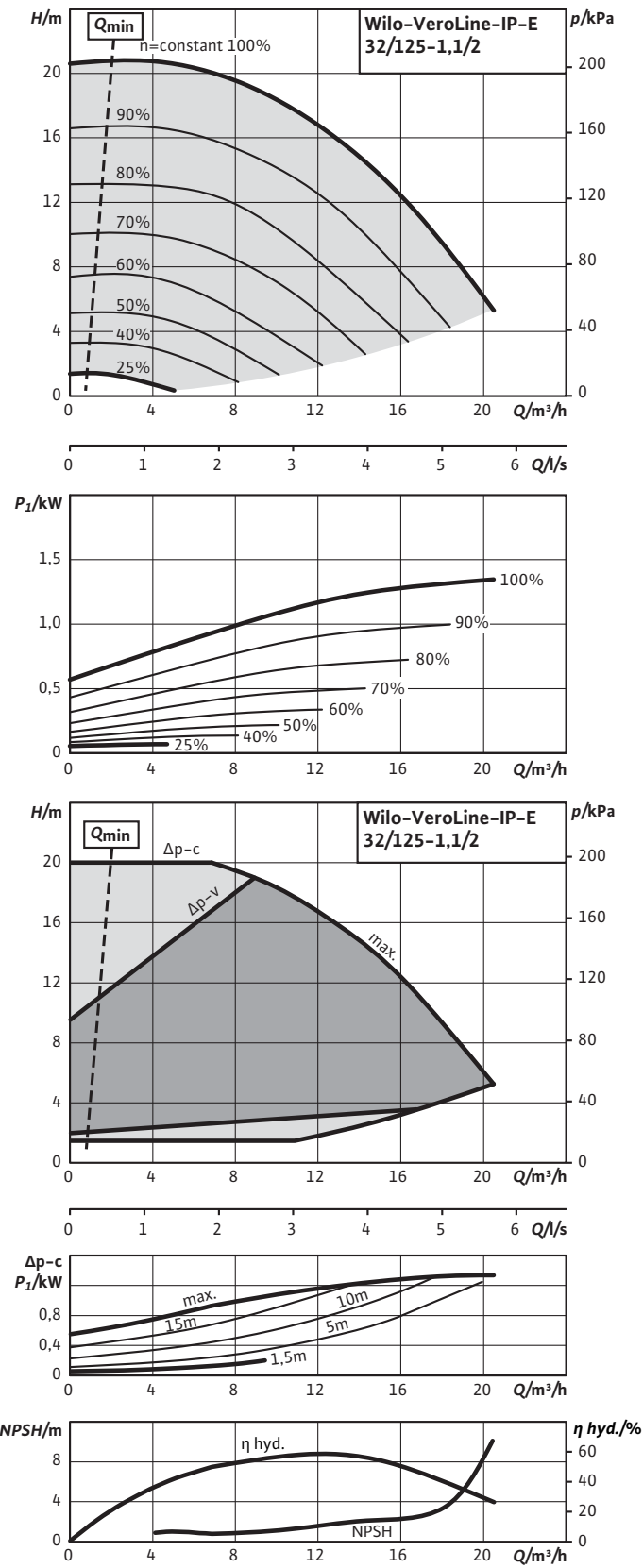

Curve caratteristiche

Veroline-IP-E 32/135-1,1/2

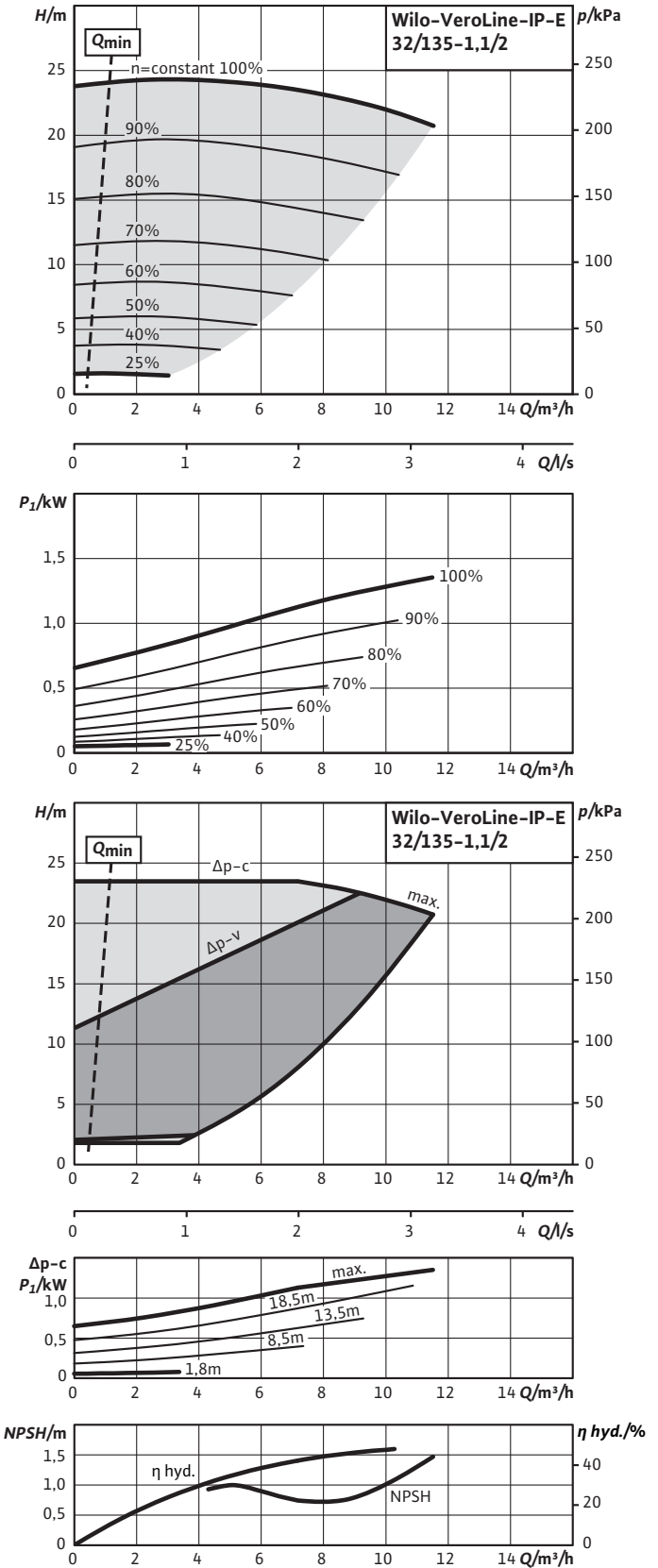

Riscaldamento, condizionamento e refrigerazione

Curve caratteristiche

Veroline-IP-E 32/135-1,5/2

Curve caratteristiche

Veroline-IP-E 40/115-0,55/2

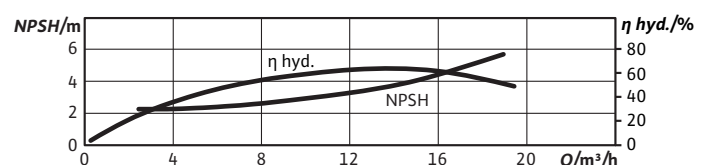
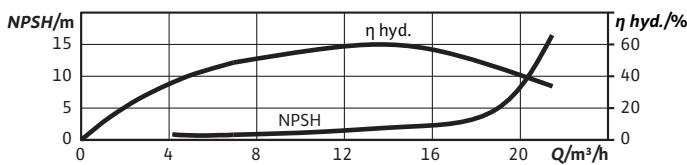
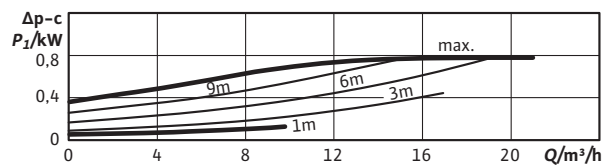
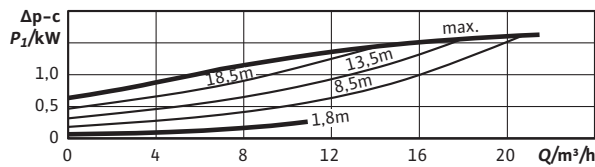
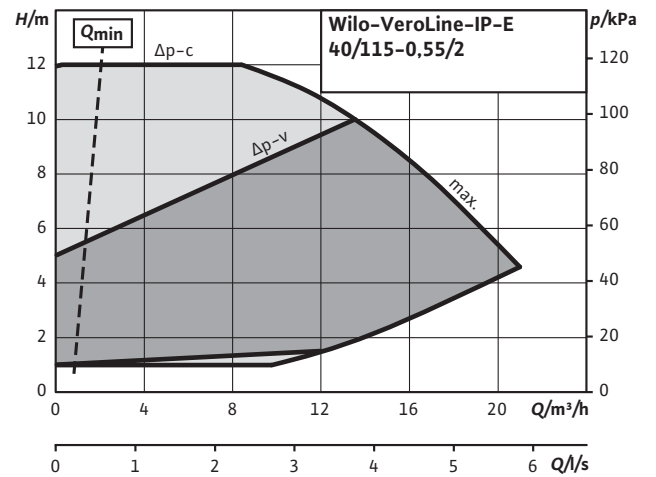
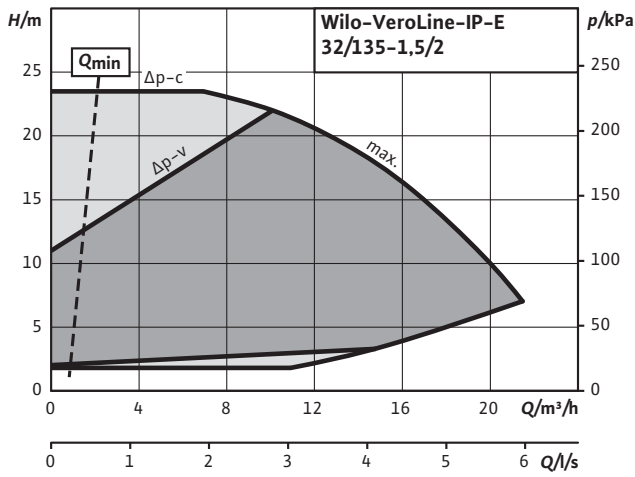
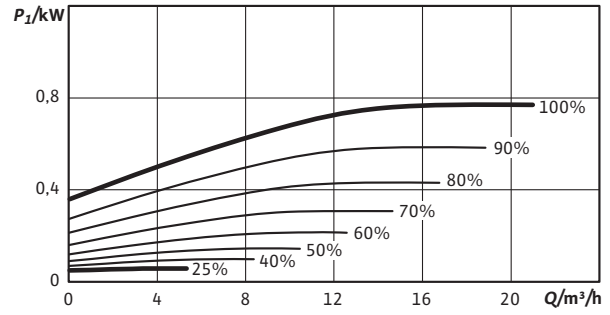
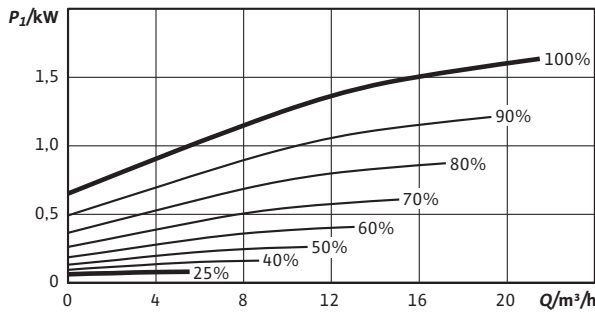
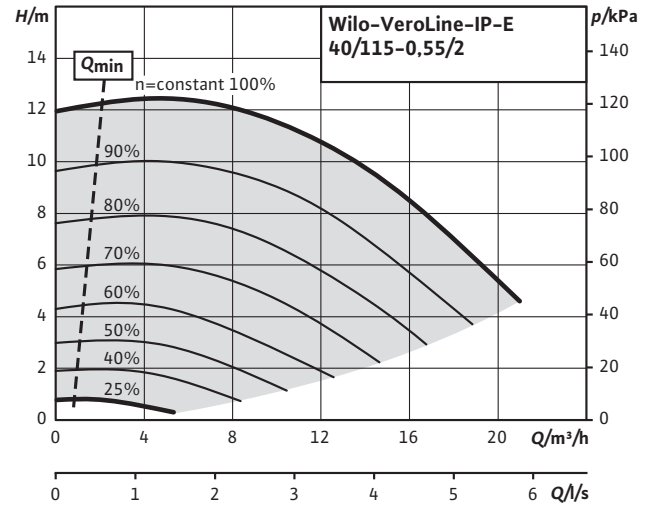
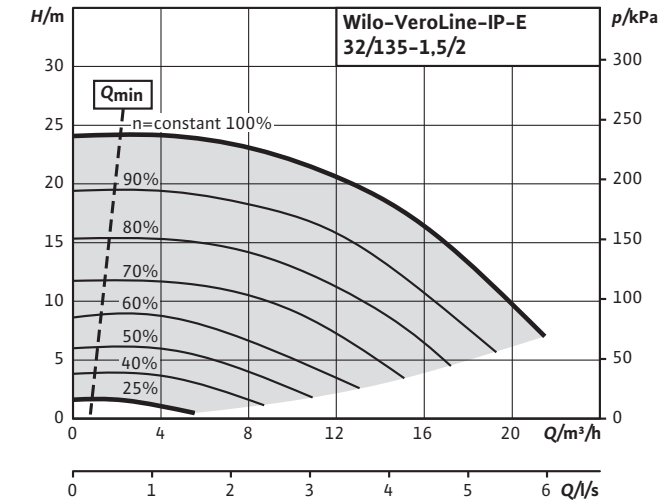

Curve caratteristiche

Veroline-IP-E 40/120-1,5/2

Curve caratteristiche

Veroline-IP-E 40/130-2,2/2

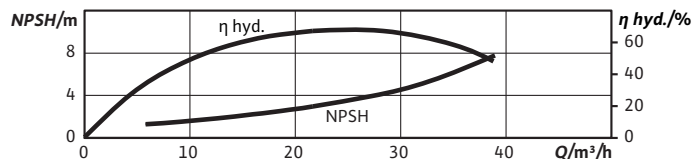
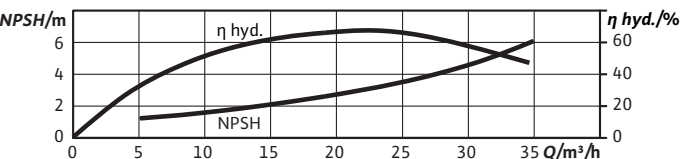
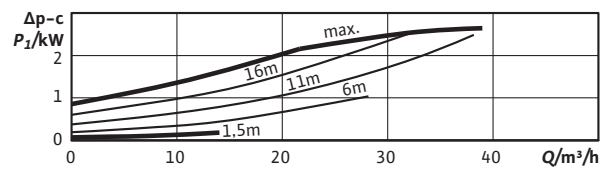
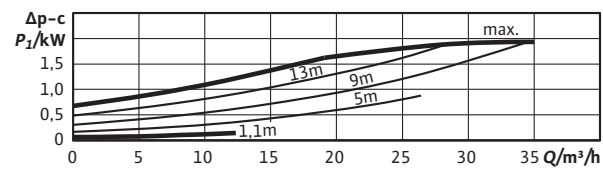
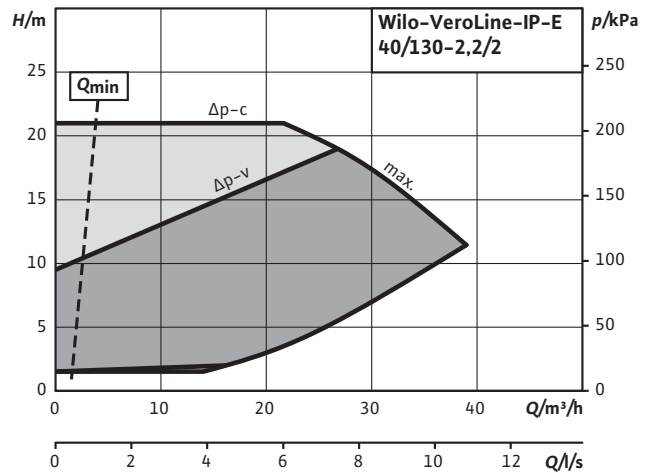
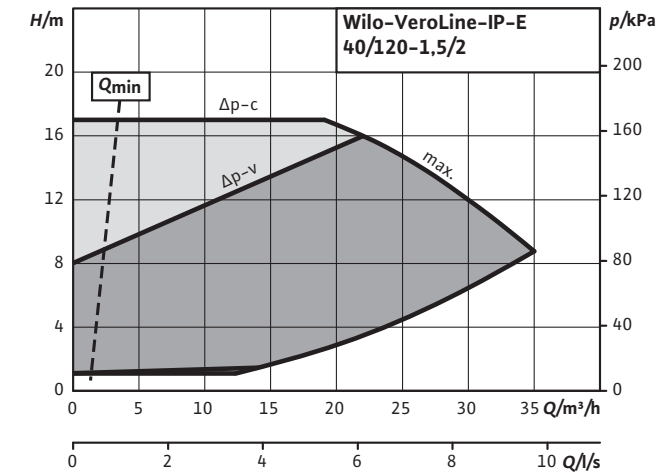
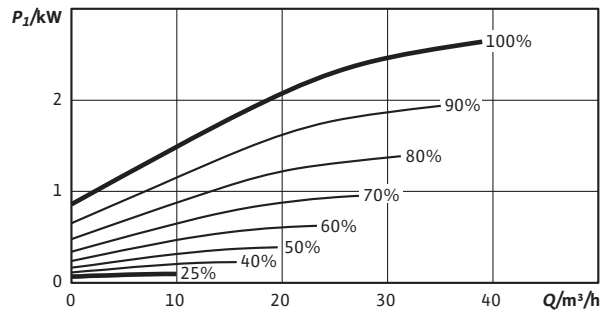
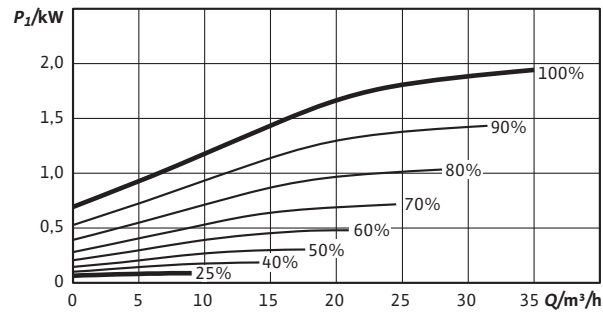
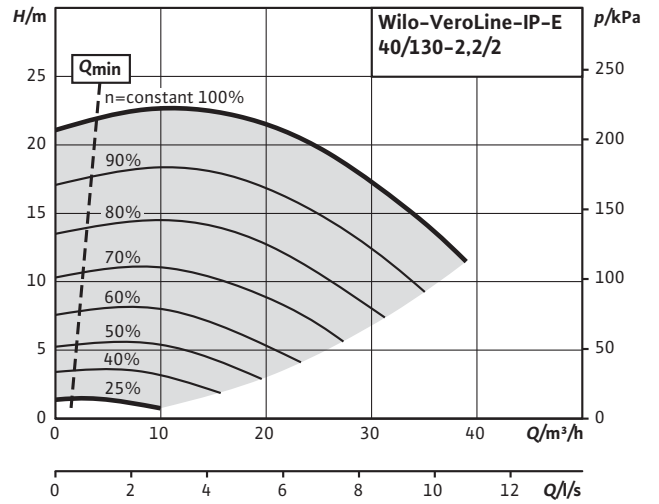
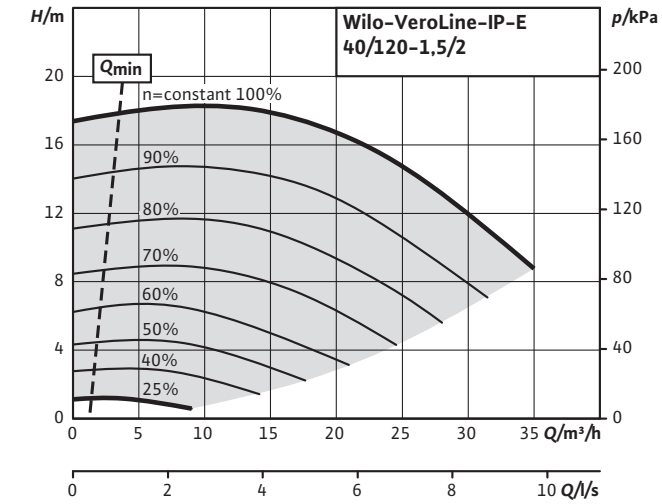

Riscaldamento, condizionamento e refrigerazione

Curve caratteristiche

VeroLine-IP-E 40/150-3/2

Curve caratteristiche

VeroLine-IP-E 40/160-4/2

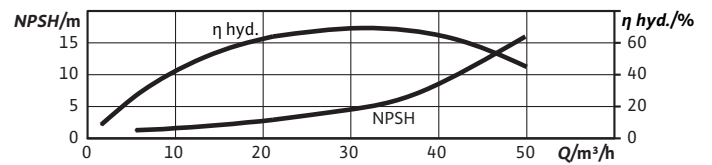
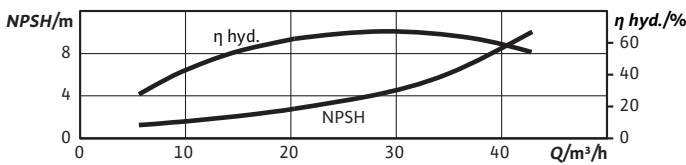
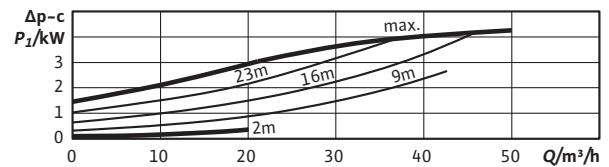
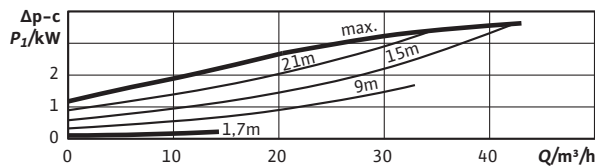
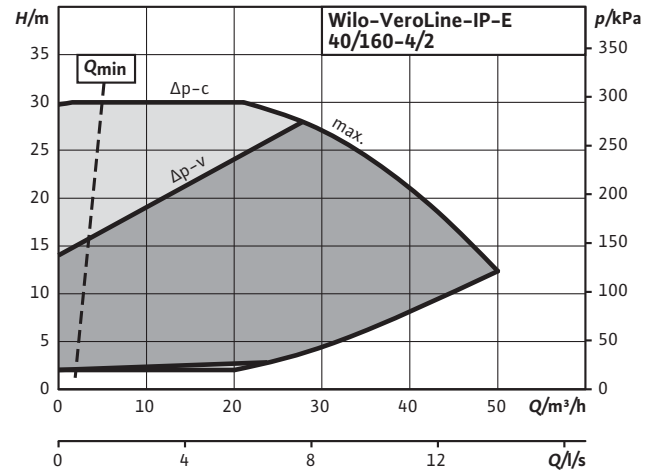
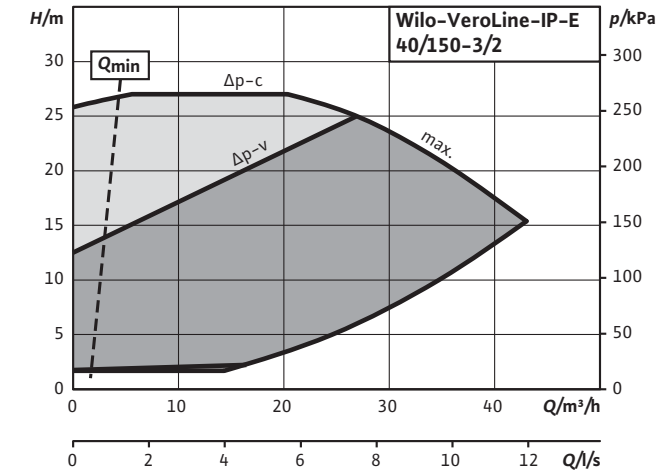
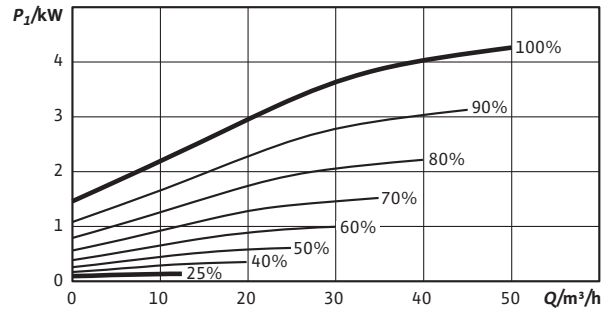
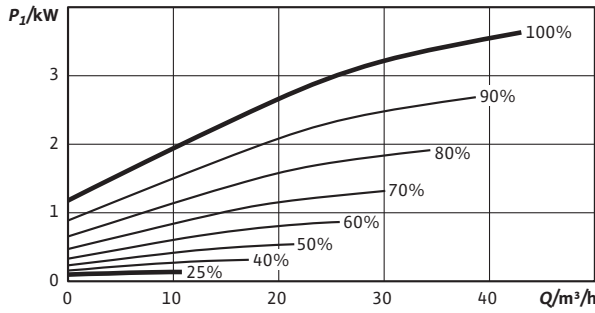
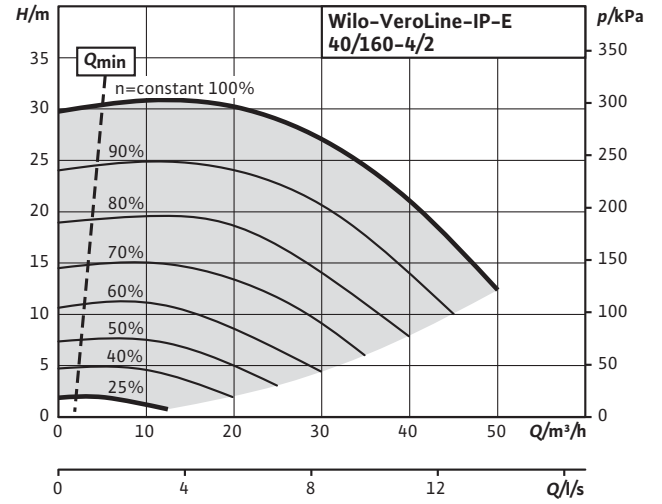
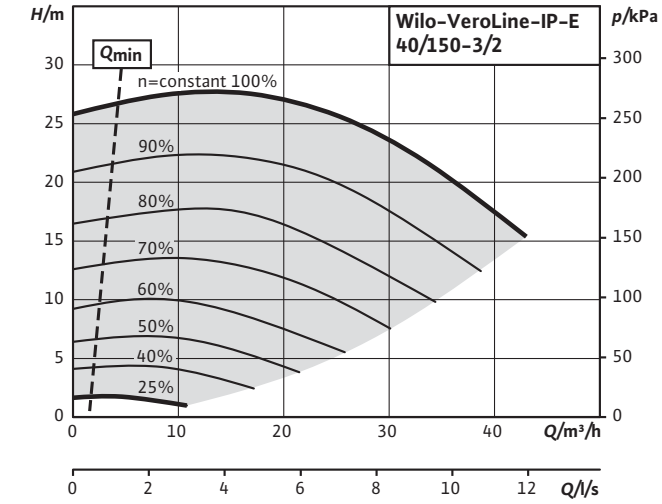

Curve caratteristiche

Veroline-IP-E 50/105-0,75/2

Curve caratteristiche

Veroline-IP-E 50/130-2,2/2

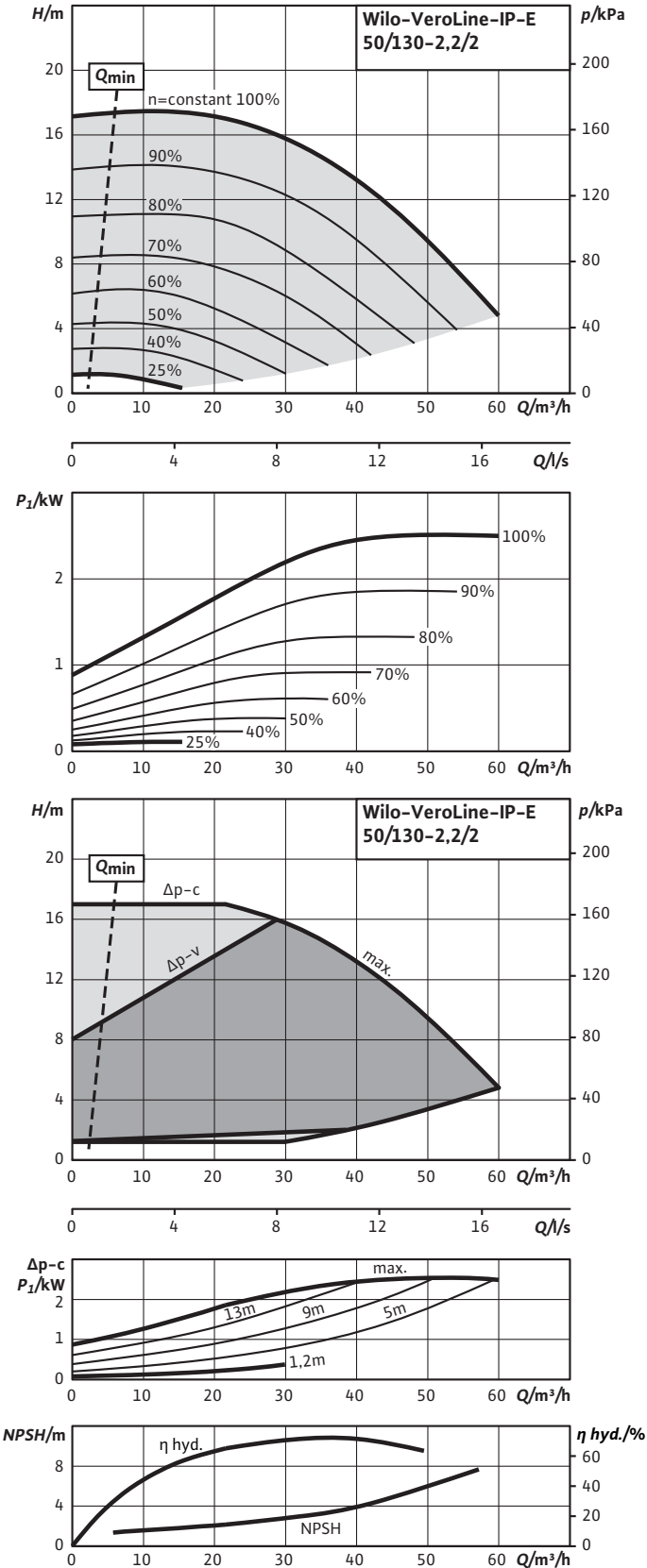
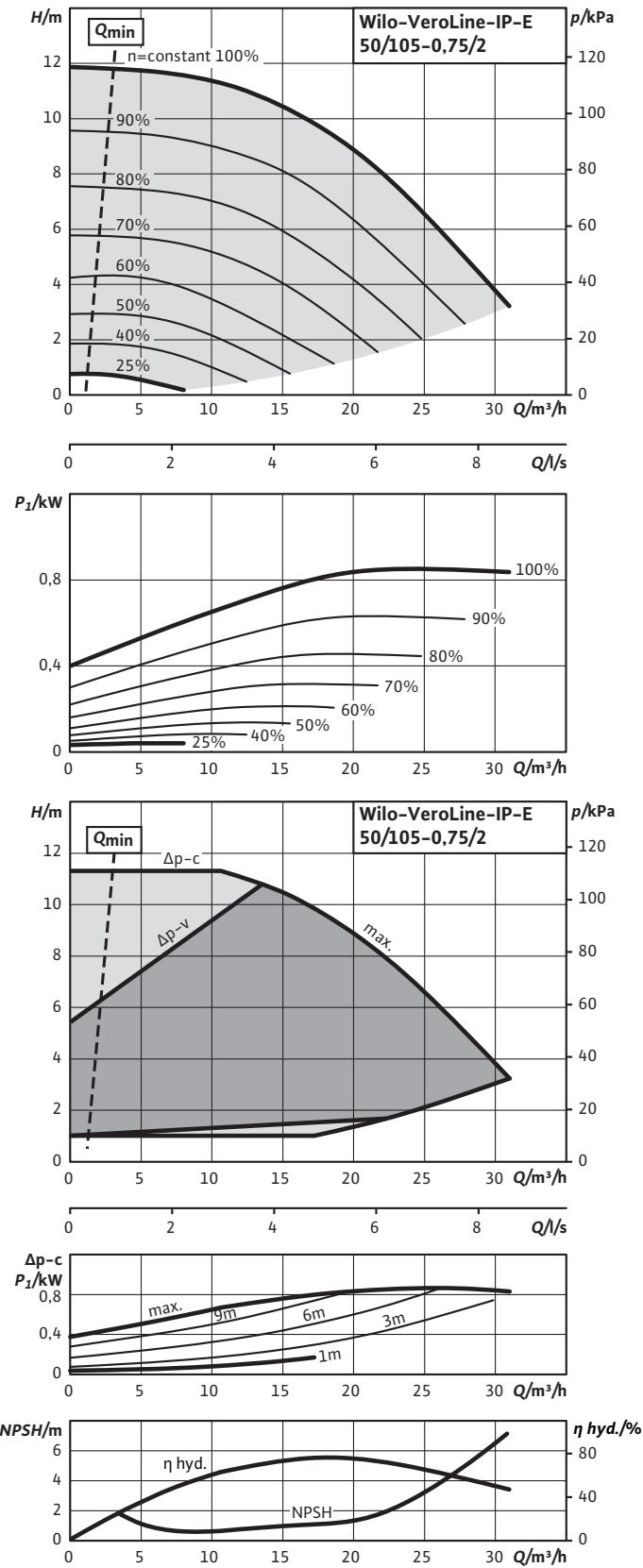

Riscaldamento, condizionamento e refrigerazione

Curve caratteristiche

Veroline-IP-E 50/140-3/2

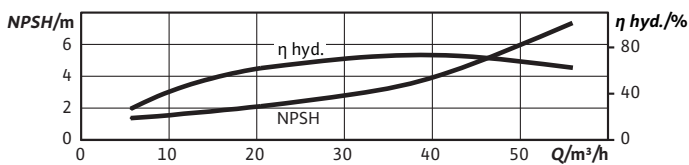
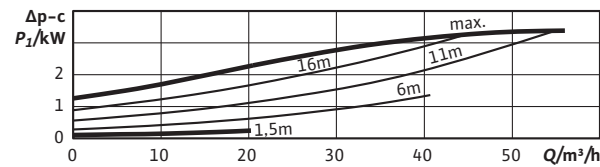
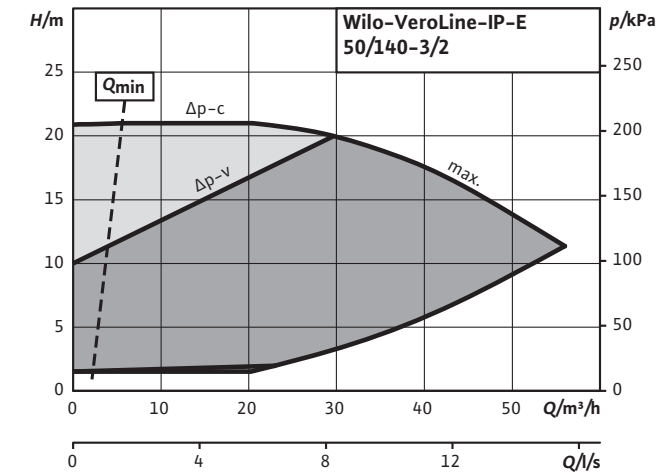
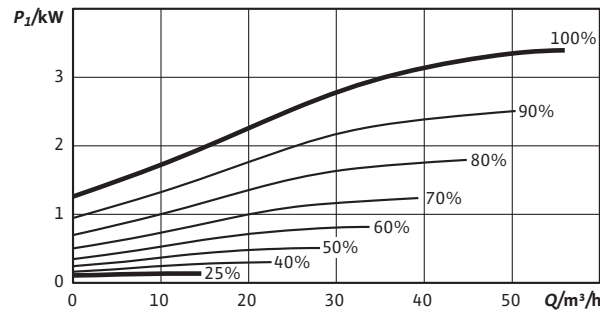
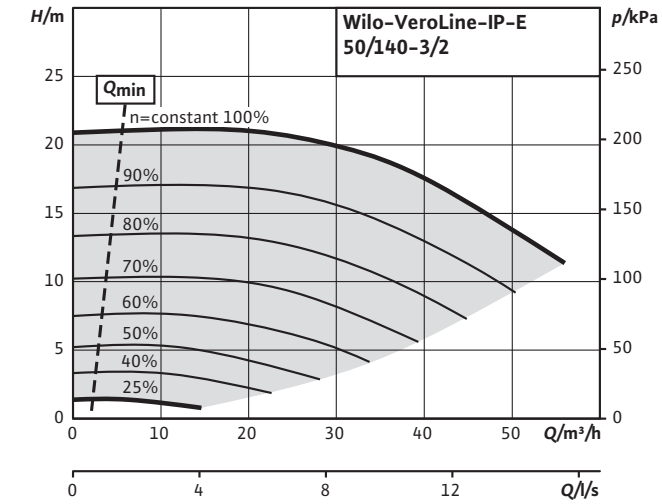

Curve caratteristiche

Veroline-IP-E 50/150-4/2

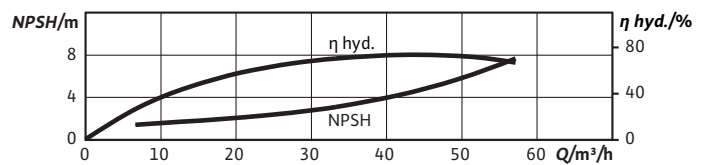
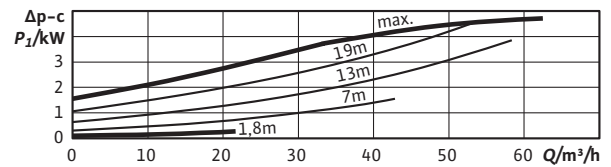
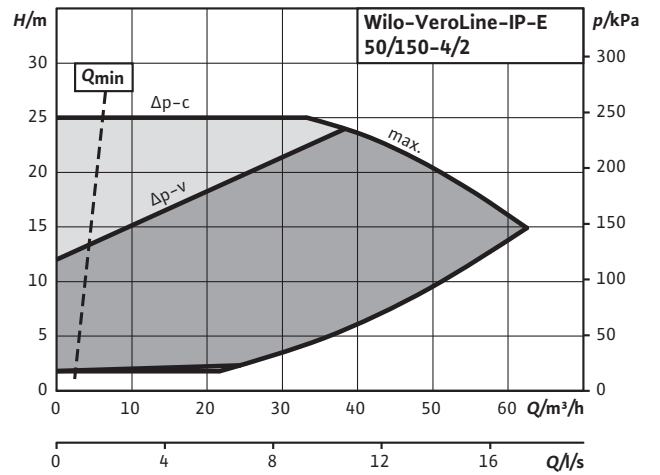
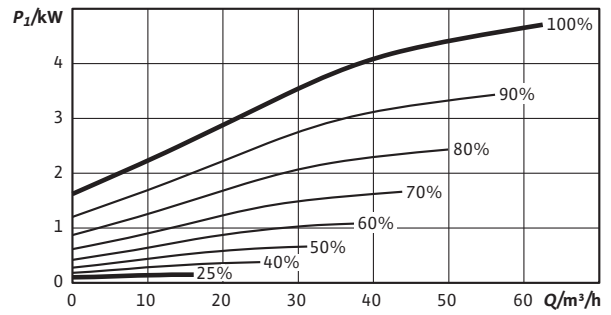
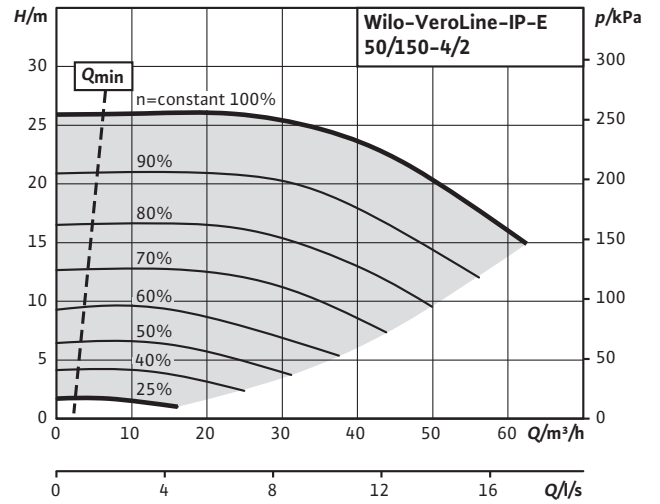



Curve caratteristiche

VeroLine-IP-E 65/110-2,2/2 VeroLine-IP-E 65/115-1,5/2

Curve caratteristiche

VeroLine-IP-E 65/110-2,2/2

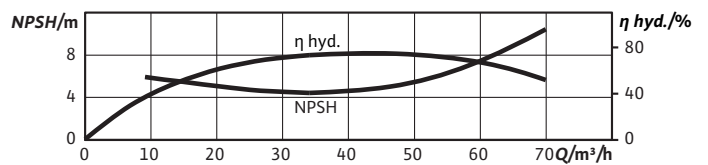
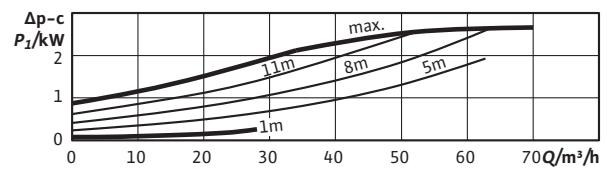
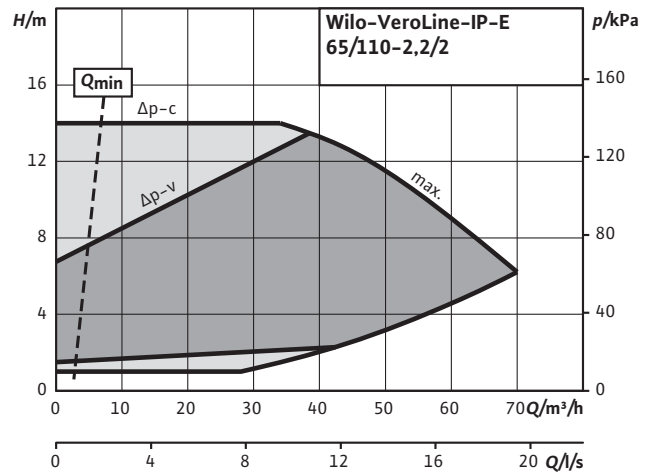
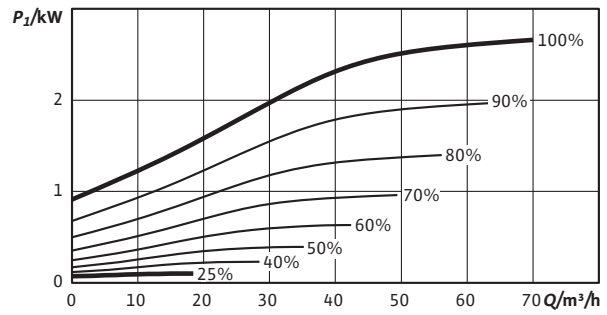
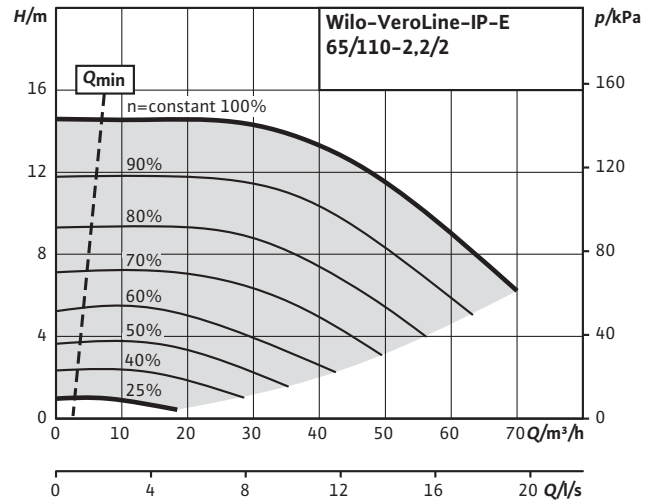
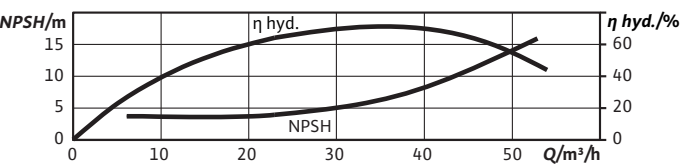
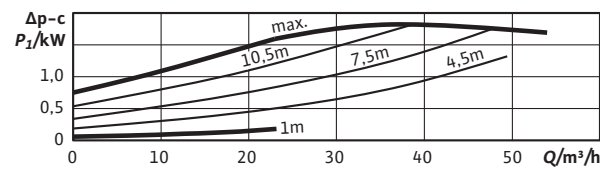
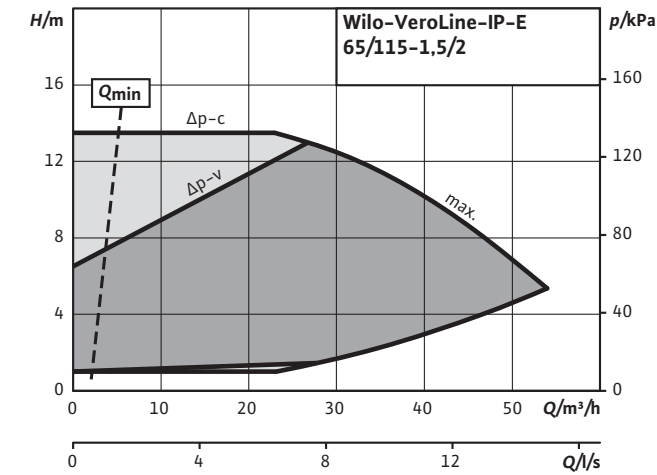
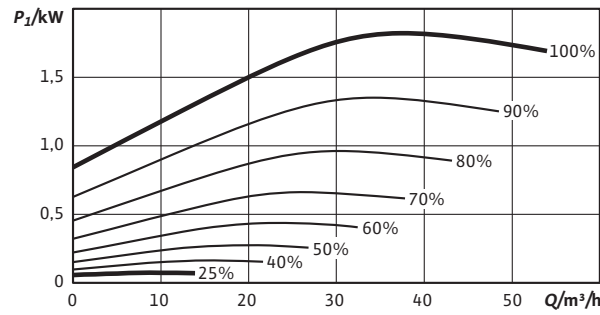
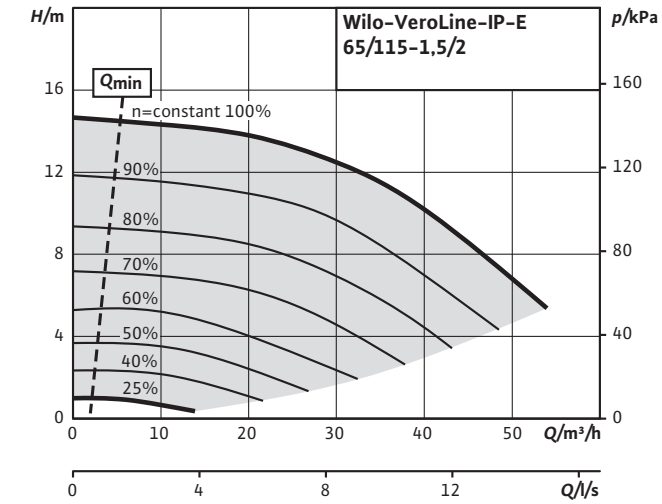

Riscaldamento, condizionamento e refrigerazione

Curve caratteristiche

Veroline-IP-E 65/120-3/2

Curve caratteristiche

Veroline-IP-E 65/130-4/2

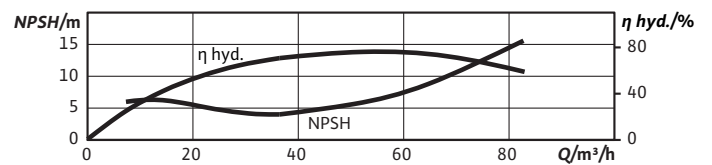
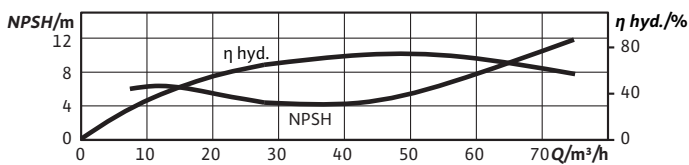
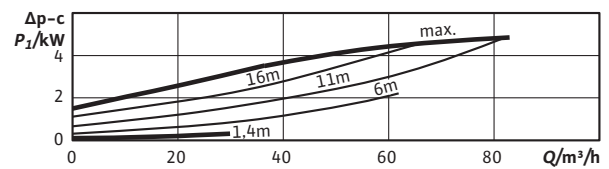
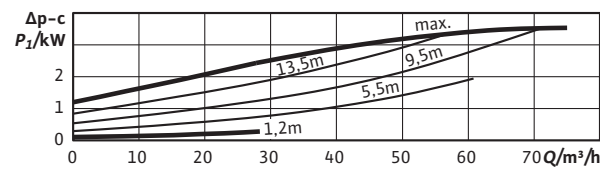
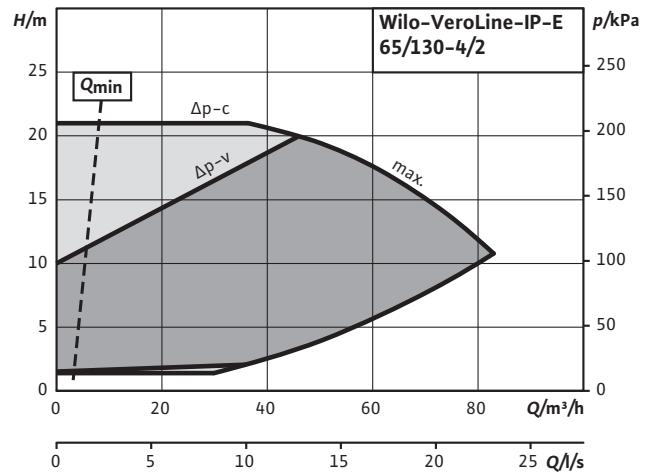
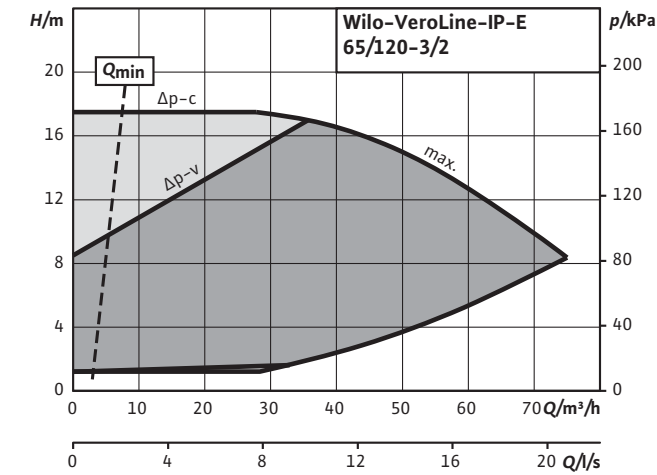
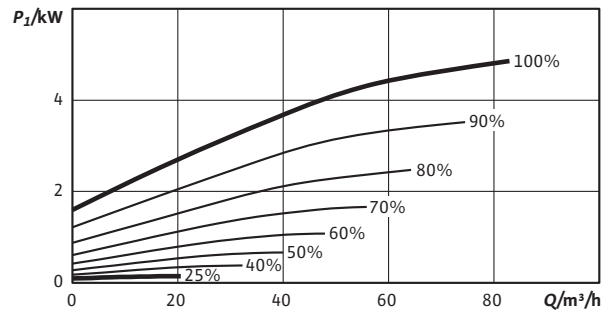
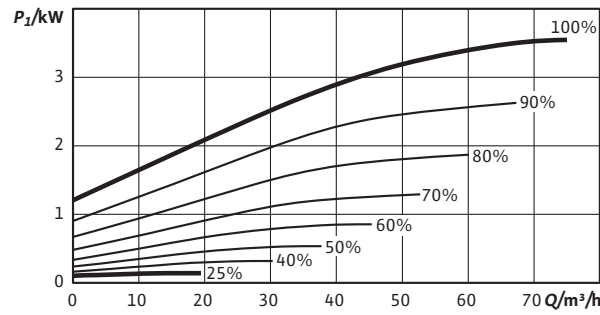
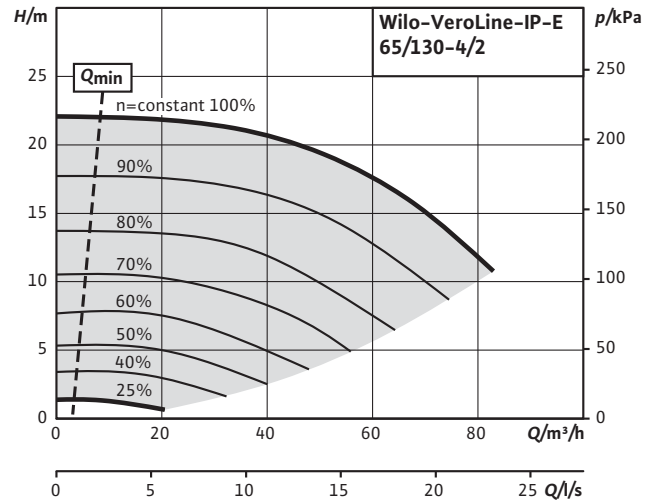
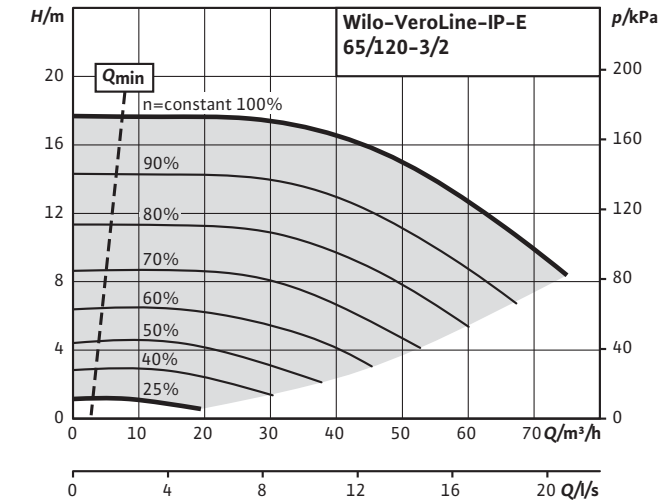

Curve caratteristiche

Veroline-IP-E 80/115-2,2/2

Curve caratteristiche

Veroline-IP-E 80/105-3/2

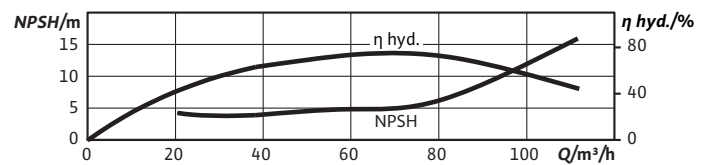
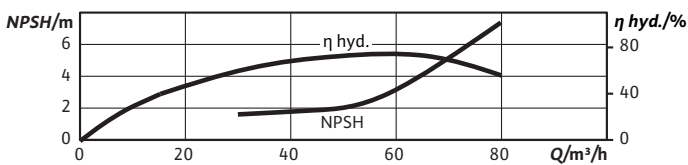
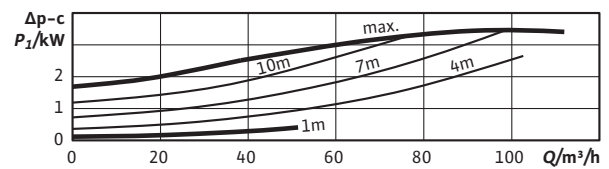
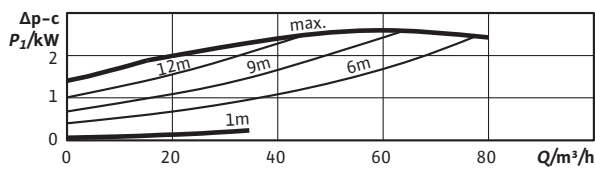
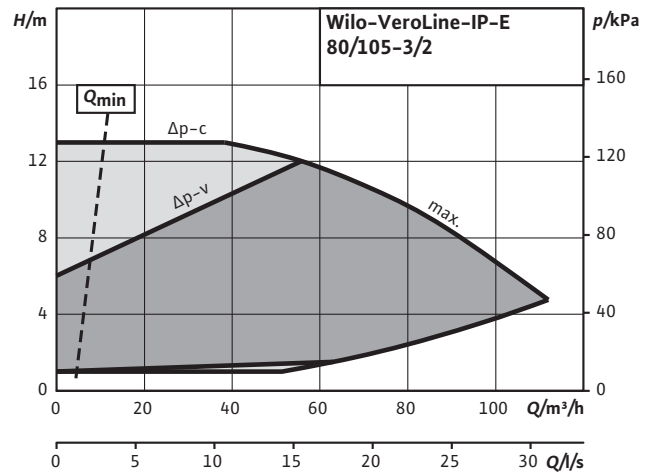
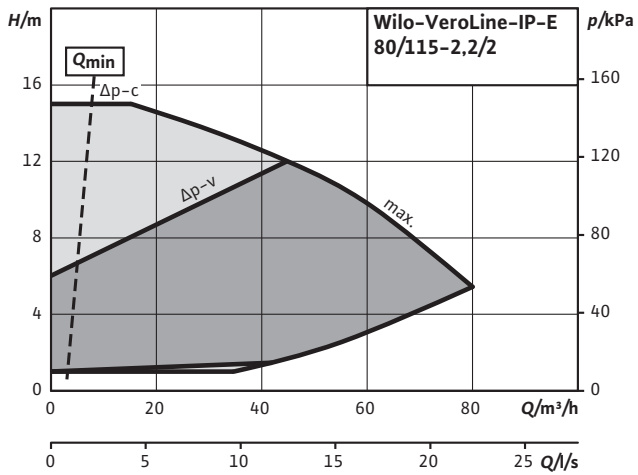
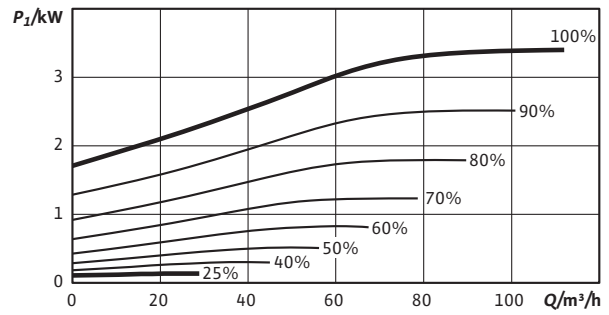
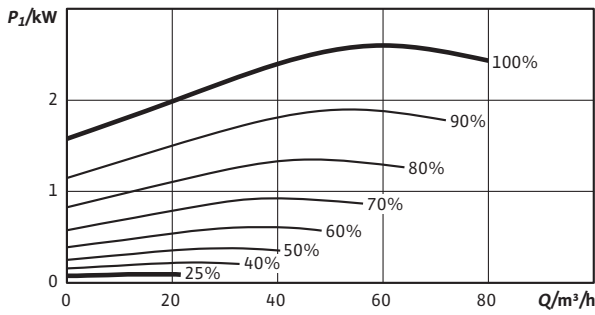
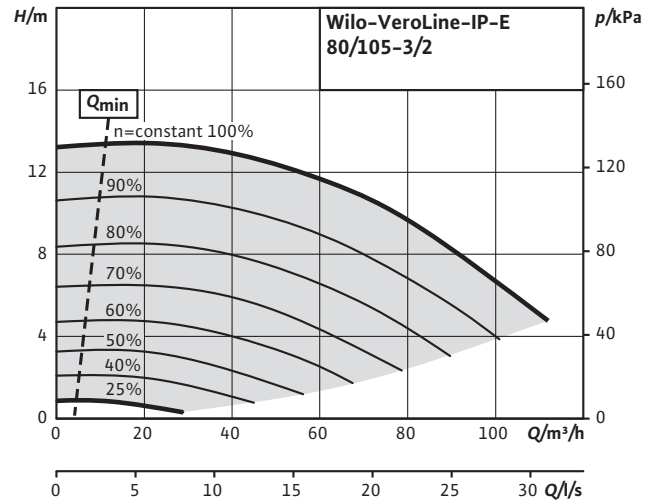
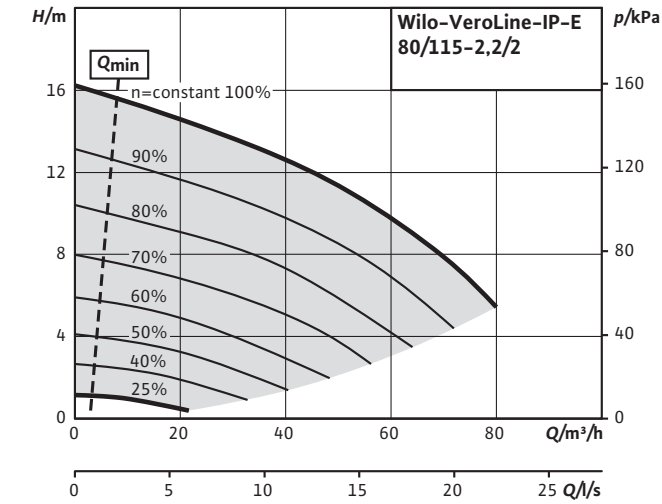

Riscaldamento, condizionamento e refrigerazione

Curve caratteristiche

Veroline-IP-E 80/110-4/2

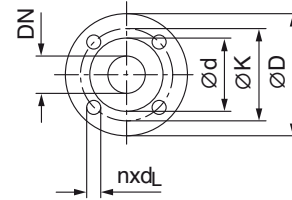
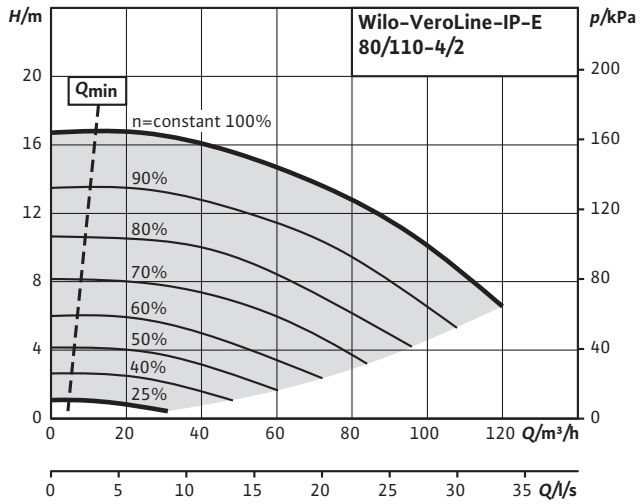

DN2	ØD	Øk	Ød	fori
	mm	mm	mm	n x Ø
32	140	100	76	4 x 19
40	150	110	84	4 x 19
50	165	125	99	4 x 19
65	185	145	118	4 x 19
80	200	160	132	8 x 19

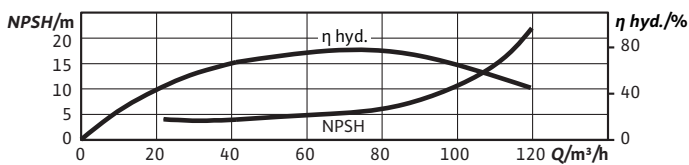
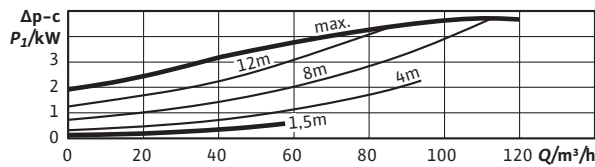
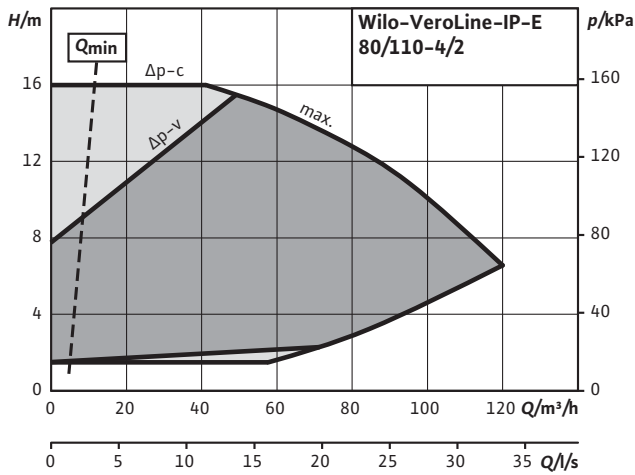
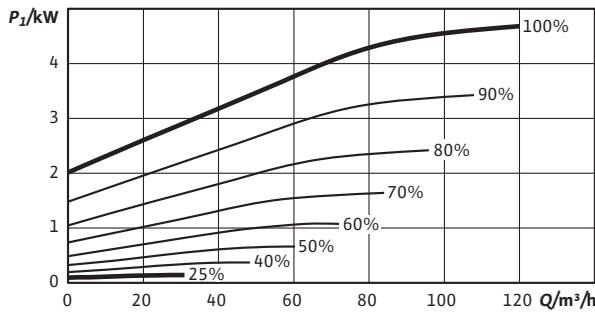

Dimensioni di ingombro e dati elettrici

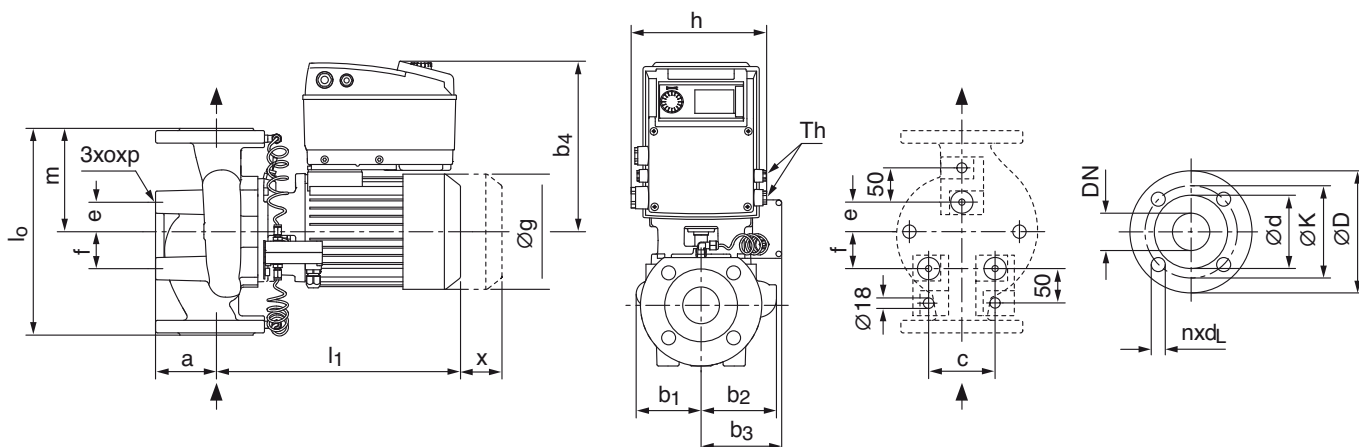

Caratteristiche elettriche e dimensionamento

Modello	MOTORE			TRASD.	POMPA														peso kg	
	POT.	INT.	DDG	DN	a	b1	b2	b3	b4	h	l0	l1	c	e	f	m	$\varnothing g$	x		
	P2	A			mm	mm	mm	mm	mm	mm	mm	mm	mm	mm	mm	mm	mm	mm		mm
	kW																			
IP-E 32/95-0,55/2	0,55	1.9	DDG 20-1	32	70	94	96	189	230	191	260	319	90	40	50	130	130	150	25	
IP-E 32/105-0,75/2	0,75	2.9	DDG 20-1	32	70	94	96	189	237	191	260	339	90	40	50	130	146	150	27	
IP-E 32/125-1,1/2	1,1	4.1	DDG 20-1	32	70	94	96	189	237	191	260	339	90	40	50	130	146	150	29	
IP-E 32/135-1,1/2	1,1	2.8	DDG 40-1	32	70	94	96	189	237	191	260	339	90	40	50	130	146	150	30	
IP-E 32/135-1,5/2	1,5	4,5	DDG 40-1	32	70	94	96	189	259	191	260	370	90	40	50	130	172	150	33	
IP-E 40/115-0,55/2	0,55	1.8	DDG 20-1	40	65	80	90	162	230	191	250	320	90	110	110	125	130	150	25	
IP-E 40/120-1,5/2	1,5	5.2	DDG 20-1	40	75	113	121	189	259	191	320	374	90	40	50	160	172	150	37	
IP-E 40/130-2,2/2	2,2	6.4	DDG 40-1	40	75	113	121	189	259	212	320	374	90	40	50	160	172	150	38	
IP-E 40/150-3/2	3	8.8	DDG 40-1	40	75	113	121	189	271	212	320	408	90	40	50	160	194	150	44	
IP-E 40/160-4/2	4	10.1	DDG 40-1	40	75	113	121	189	283	212	320	440	90	40	50	160	218	150	51	
IP-E 50/105-0,75/2	0,75	3.2	DDG 20-1	50	75	87	101	162	237	191	280	343	90	125	125	140	146	150	30	
IP-E 50/130-2,2/2	2,2	6.6	DDG 20-1	50	86	116	131	189	259	212	340	376	104	40	50	170	172	150	41	
IP-E 50/140-3/2	3	8.8	DDG 40-1	50	86	116	131	189	271	212	340	410	104	40	50	170	194	150	47	
IP-E 50/150-4/2	4	11.7	DDG 40-1	50	86	116	131	189	283	212	340	442	104	40	50	170	218	150	54	
IP-E 65/115-1,5/2	1,5	5.2	DDG 20-1	65	80	100	118	167	259	191	340	387	104	155	155	170	172	150	41	
IP-E 65/110-2,2/2	2,2	6.9	DDG 20-2	65	93	119	138	189	259	212	340	380	135	40	55	170	172	150	58	
IP-E 65/120-3/2	3	9.5	DDG 20-3	65	93	119	138	189	271	212	340	414	135	32	63	170	194	150	50	
IP-E 65/130-4/2	4	10.8	DDG 40-3	65	93	119	138	189	283	212	340	446	135	32	63	170	218	150	57	
IP-E 80/115-2,2/2	2,2	6.5	DDG 20-3	80	98	110	135	167	240	212	360	389	135	165	165	180	172	150	46	
IP-E 80/105-3/2	3	9.2	DDG 40-3	80	105	125	154	189	271	212	360	422	135	40	55	180	194	150	55	
IP-E 80/110-4/2	4	10.9	DDG 20-2	80	105	125	154	189	283	212	360	454	135	40	55	180	218	150	60	

Riscaldamento, condizionamento e refrigerazione

# Wilo-VeroTwin DP-E

Pompa gemellare a motore ventilato regolata elettronicamente

Per impianti di riscaldamento, condizionamento e refrigerazione commerciali ed industriali.

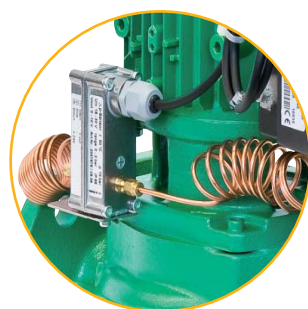

## Esecuzione

Pompe gemellari complete di trasduttore di pressione differenziale in esecuzione standard pronte per funzionamento MASTER/SLAVE



## Efficienza

Motore elettrico in classe di efficienza IE4



## Idraulica

Idraulica ad alta efficienza Indice MEI 0,4



Per maggiori informazioni sui prodotti:  
[www.wilo.it](http://www.wilo.it)



### Focus

- Efficienza idraulica  $MEI=0,4$   
(secondo Direttiva ErP Regolamento CE n.547/2012)
- Efficienza motore IE4 (secondo IEC TS 60034-31 Ed.1)

### Vantaggi

- Campo di regolazione fino a tre volte maggiore delle pompe tradizionali regolate elettronicamente
- Con le interfacce seriali WIL0-IF si integra con qualsiasi sistema di automazione degli edifici (BMS)

### In evidenza

Il display LCD di grandi dimensioni permette di visualizzare rapidamente i dati di SET della pompa.



### Tecnologia

La tecnologia 'pulsante rosso' rende la regolazione e l'installazione della pompa semplice e rapida.



### Installazione

I moduli WIL0-IF permettono la connessione a tutte le reti di Building Management System.



APPLIES TO EUROPEAN DIRECTIVE FOR ENERGY RELATED PRODUCTS



Range Upgrade



## Wilo-VeroTwin-DP-E



### Chiave di lettura

Esempio	<b>DP-E 40/160-4/2-R1</b>
<b>DP-E</b>	Pompa gemellare inline con regolazione elettronica
<b>40</b>	Diametro nominale DN della bocca
<b>160</b>	Diametro nominale della girante
<b>4</b>	Potenza nominale del motore $P_2$ in kW
<b>2</b>	Numero poli
<b>R1</b>	Versione senza sensore

### Particolarità/vantaggi del prodotto

- Motore elettrico IE4
- Risparmio energetico grazie alla regolazione della velocità integrata
- WILO-Moduli-IF opzionale per l'integrazione in sistemi di building automation
- Tecnologia del pulsante rosso e display per un semplice utilizzo
- Management integrato pompa doppia
- Protezione integrale del motore

### Dati tecnici

Indice di efficienza minimo (MEI)	≥ 0,4
<b>Fluidi consentiti (altri fluidi su richiesta)</b>	
Acqua riscaldamento (secondo VDI 2035)	Sì
Miscela acqua/glicole (con 20-40 % vol. di glicole e temperatura fluido ≤ 40 °C)	Sì
Acqua fredda e refrigerata	Sì
Olio diatermico	Versione speciale
<b>Campo d'applicazione consentito</b>	
Campo di temperatura con una temperatura ambiente max. di +40 °C	-20...+120 °C (a seconda del fluido di pompaggio)
Pressione nominale $P_N$	10 bar
<b>Alimentazione elettrica</b>	
Alimentazione rete	3~440 V ±10%, 50/60 Hz 3~400 V ±10%, 50/60 Hz 3~380 V -5%/+10%, 50/60 Hz

### Dati tecnici

<b>Motore/elettronica</b>	
Indice di efficienza motore elettrico	IE4
Protezione integrale del motore	Sì
Grado protezione	IP 55
Classe isolamento	F
Compatibilità elettromagnetica-Emissione	EN 61800-3
Compatibilità elettromagnetica-Immunità	EN 61800-3
<b>Materiali</b>	
Corpo pompa	EN-GJL-250
Lanterna	EN-GJL-250
Girante	PPO-GF30
Albero della pompa	1.4021 [AISI420]
Tenuta meccanica	AQEGG
Altre tenute meccaniche	su richiesta



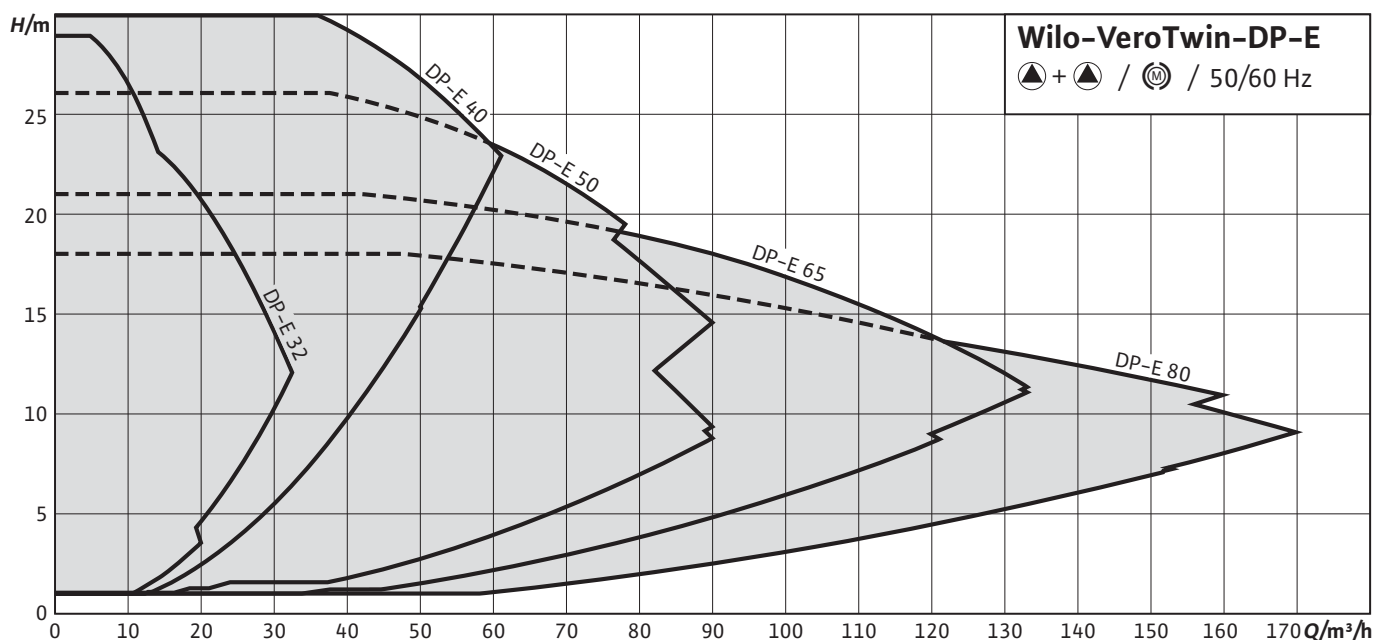

### Equipaggiamento/funzionamento

#### Modi di funzionamento

- $\Delta p$ -c per pressione differenziale costante
- $\Delta p$ -v per pressione differenziale variabile
- Controllo PID
- Funzionamento come servomotore ( $n = \text{costante}$ )

#### Livello di comando

- Pulsante rosso e display

#### Funzioni manuali

- Impostazione pompa on/off
- Impostazione del modo funzionamento
- Configurazione di tutti i parametri di esercizio
- Impostazione del numero di giri

#### Funzioni di comando esterne

- Ingresso di comando "prioritario Off"
- Ingresso di comando "scambio pompa" (solo con funzionamento a pompa doppia)
- Ingresso analogico per funzionamento come servomotore (DDC) e regolazione a distanza del valore di consegna:
  - 0–10 V
  - 2–10 V
  - 0–20 mA
  - 4–20 mA
- Ingresso analogico per segnale diretto dal sensore di pressione:
  - 0–10 V
  - 2–10 V
  - 0–20 mA
  - 4–20 m

#### Funzioni di segnalazione e visualizzazione

- Segnalazione cumulativa di blocco SSM
- Segnalazione cumulativa di funzionamento SBM

#### Scambio dati

- Porta di comunicazione a infrarossi per lo scambio dati senza fili con monitor IR o WILO-IR STICK
- Vano per innesto di moduli IF Wilo (Modbus, BACnet, CAN, PLR, LON) per interfaccia al sistema di automazione degli edifici (BMS)

#### Funzioni di sicurezza

- Protezione integrale del motore con elettronica di sgancio integrata
- Blocco accesso (regolazione)

#### Management pompa doppia (1 pompa gemellare)

- Funzionamento principale/di riserva scambio pompa dopo 24 ore di funzionamento (o eventuale anomalia ad una pompa)
- Funzione pompa doppia (somma di portata) punto di funzionamento ottimizzato al migliore rendimento

#### Opzioni

- Versione ...-R1 senza trasduttore di pressione differenziale
- Variante ...-H5 con corpo PN16
- Variante ...-S1/-S2 con tenuta meccanica speciale

#### Accessori

- 3 mensole con materiale di fissaggio per montaggio a basamento
- Monitor IR, WILO-IR STICK
- Modulo IF PLR per collegamento a PLR/convertitore porta di comunicazione
- Modulo IF LON per collegamento alla rete LONWORKS
- Modulo IF BACnet
- Modulo IF Modbus
- Modulo IF CAN
- Quadri elettrici di controllo VR-HVAC
- Quadri elettrici di controllo CCe-HVAC
- Quadri elettrici di controllo SCe-HVAC
- Trasduttore differenza di pressione (DDG)

Curve caratteristiche

Verotwin-DP-E 32/95-0,55/2 (Funzionamento singolo)

Curve caratteristiche

Verotwin-DP-E 32/95-0,55/2 (Funzionamento parallelo)

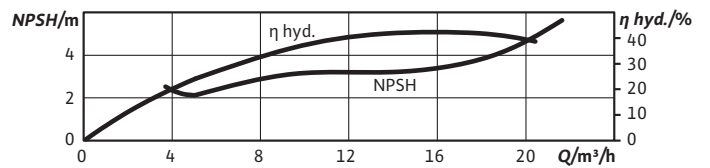
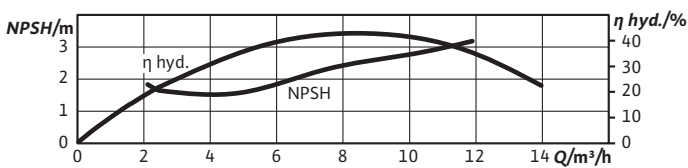
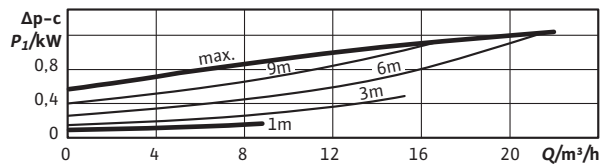
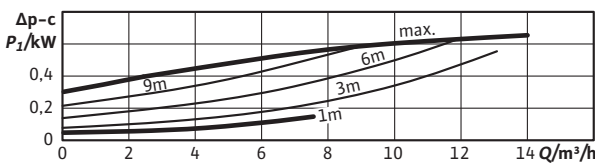
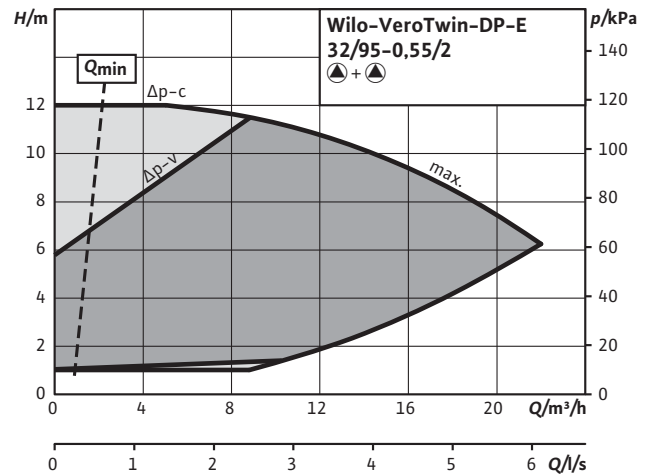
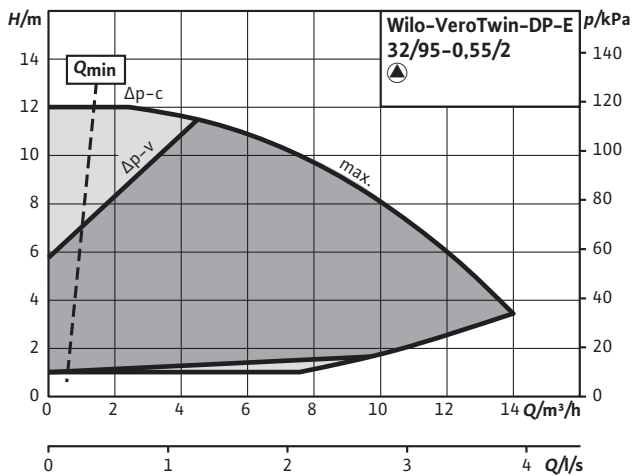
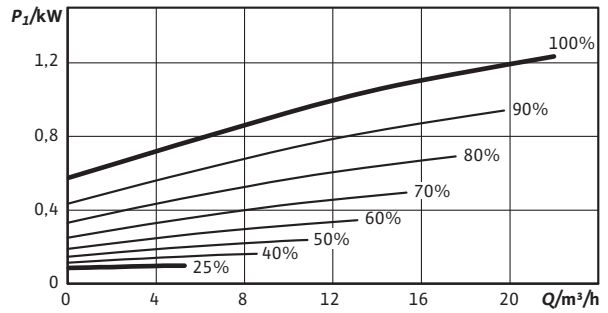
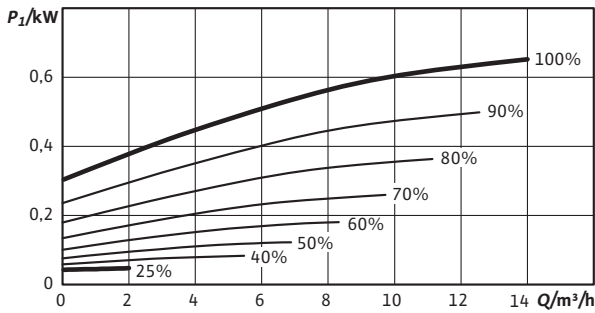
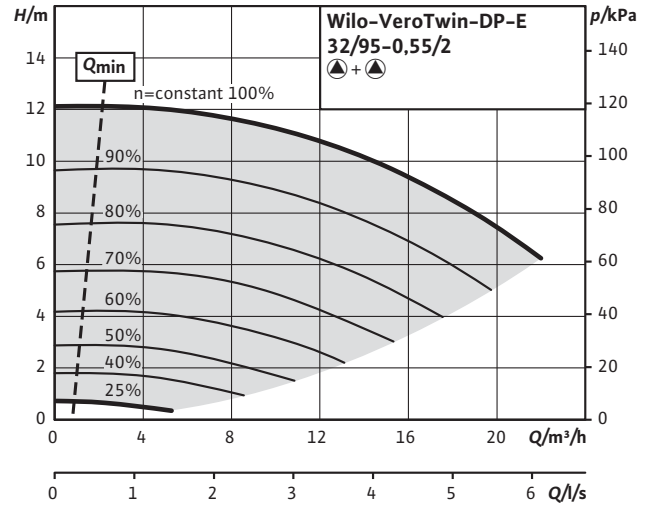
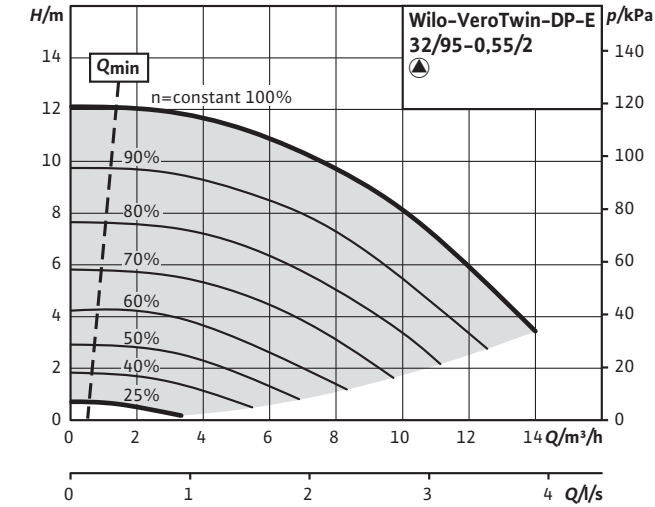

Curve caratteristiche

Verotwin-DP-E 32/105-0,75/2 (Funzionamento singolo)

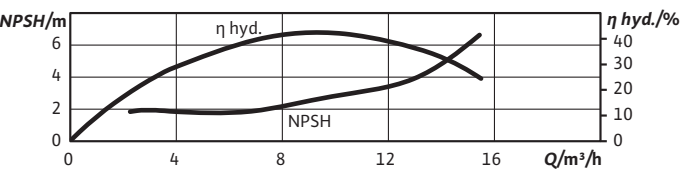
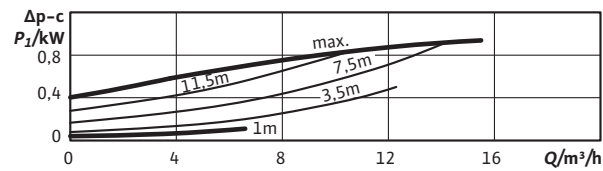
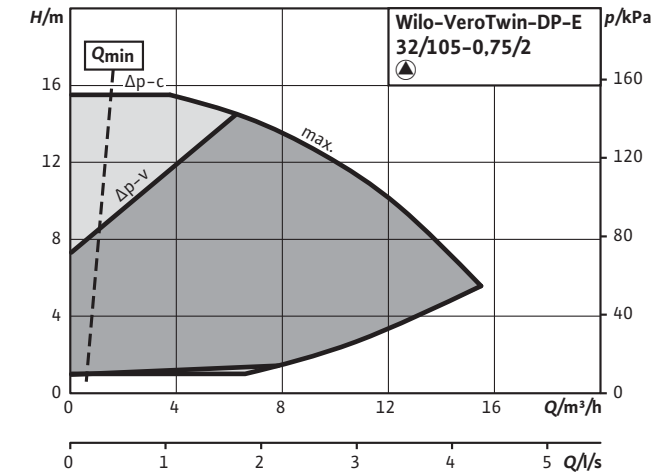
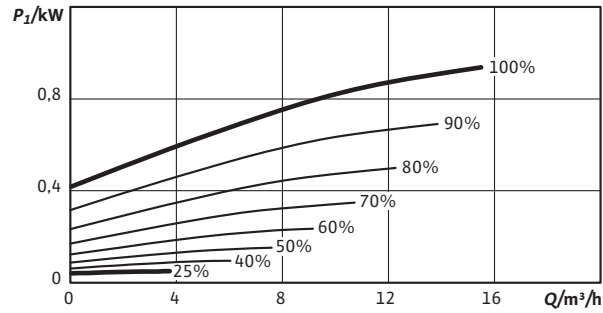
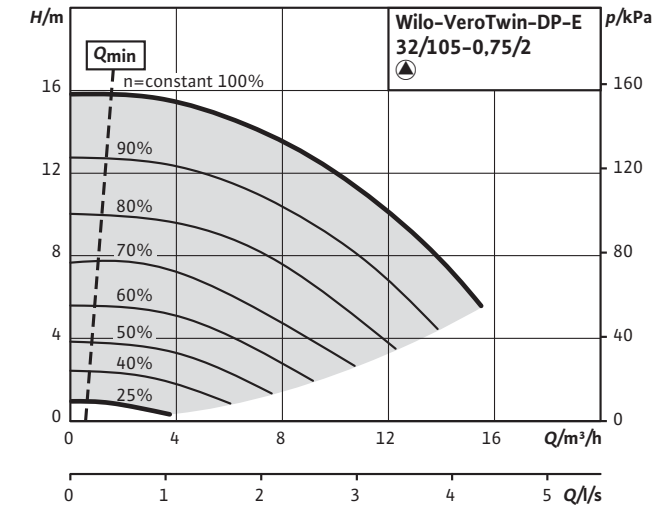

Curve caratteristiche

Verotwin-DP-E 32/105-0,75/2 (Funzionamento parallelo)

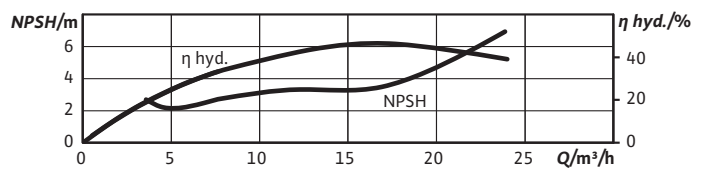
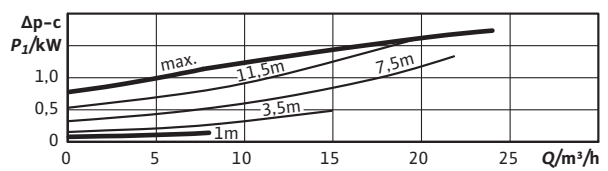
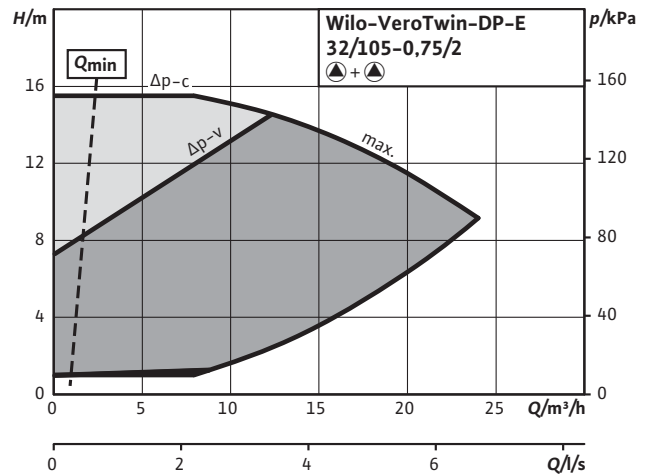
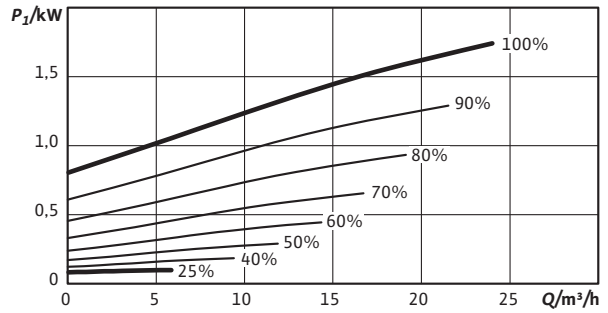
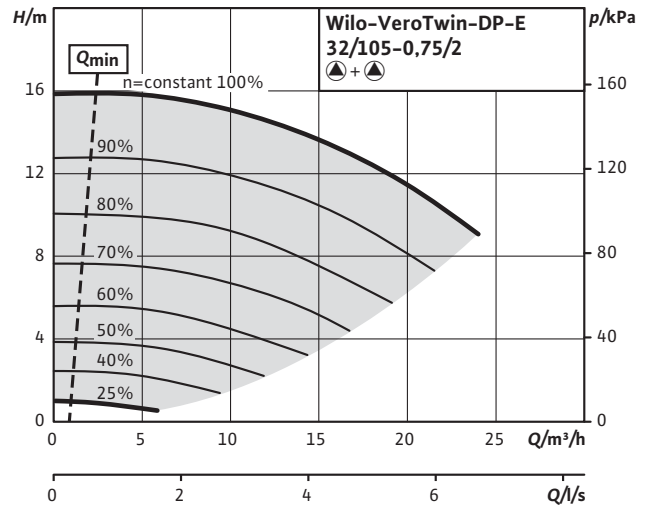

Riscaldamento, condizionamento e refrigerazione

Curve caratteristiche

VeroTwin-DP-E 32/125-1,1/2 (Funzionamento singolo)

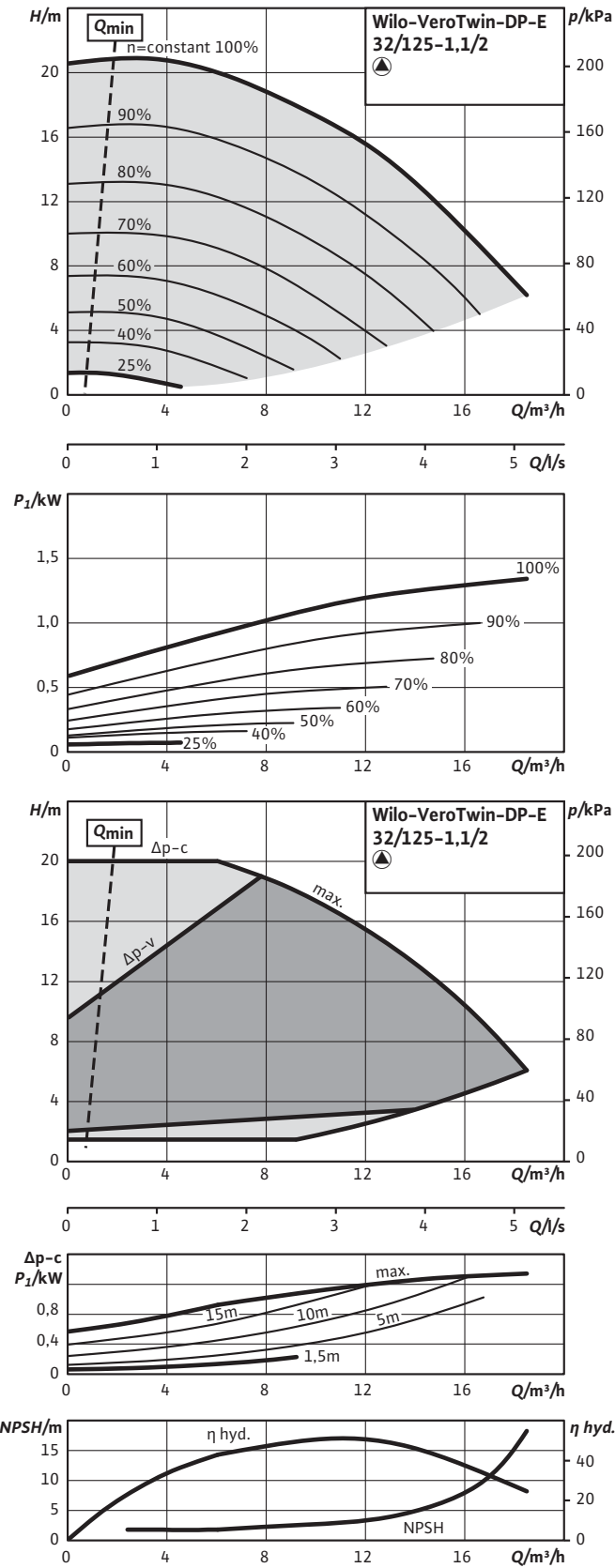

Curve caratteristiche

VeroTwin-DP-E 32/125-1,1/2 (Funzionamento parallelo)

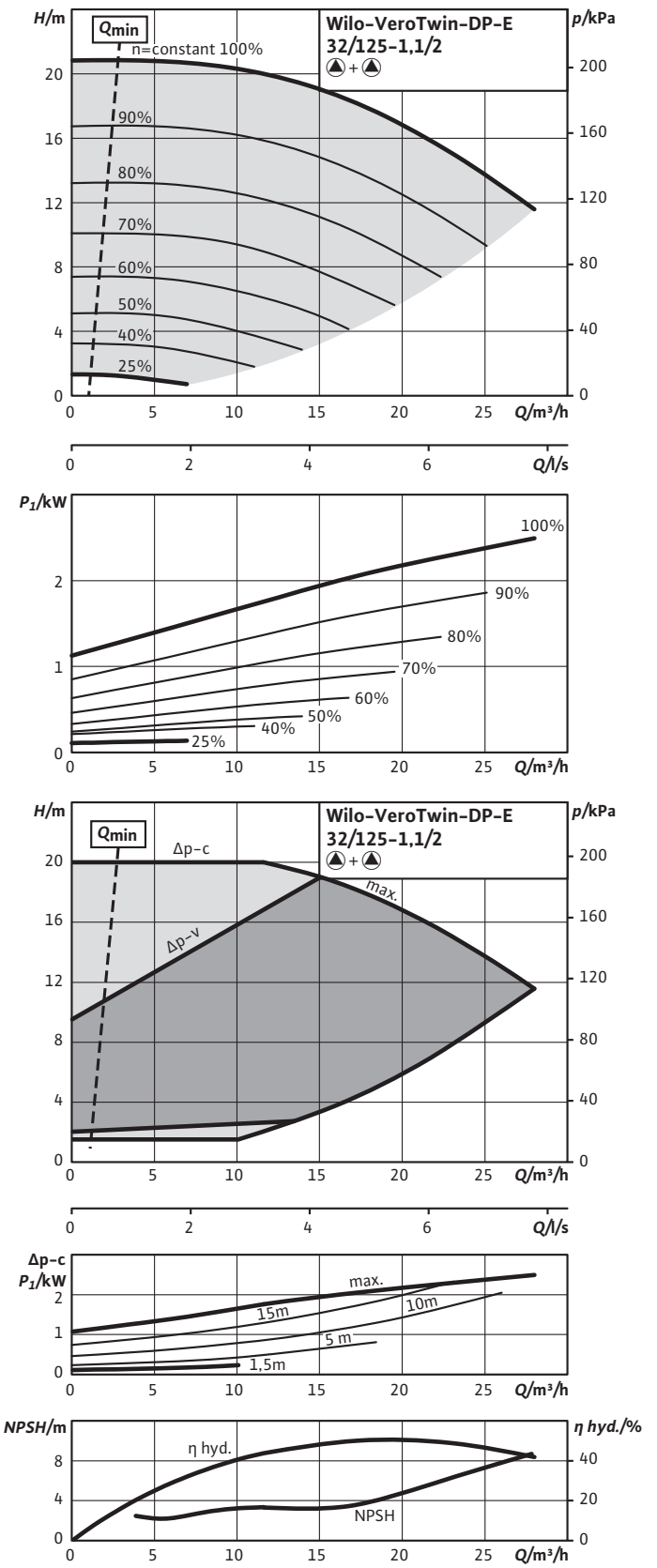

Curve caratteristiche

Verotwin-DP-E 32/135-1,1/2 (Funzionamento singolo)

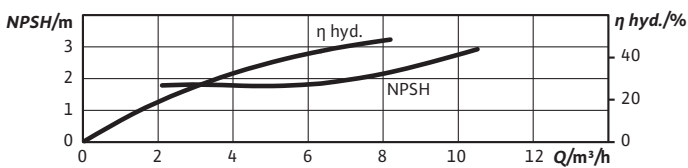
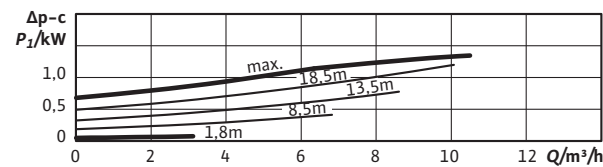
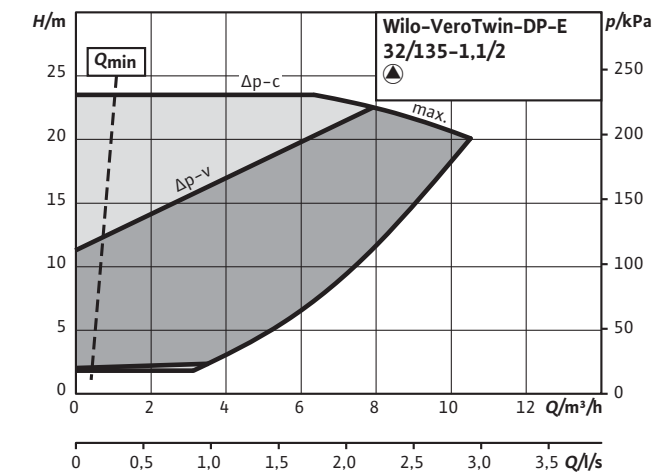
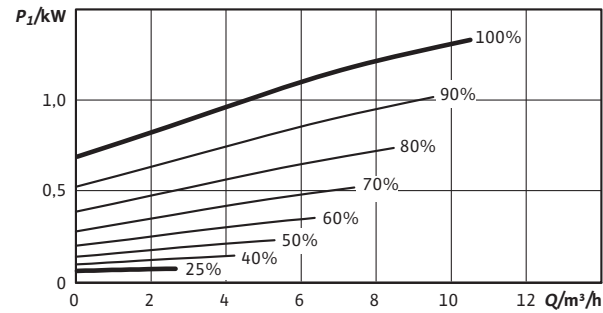
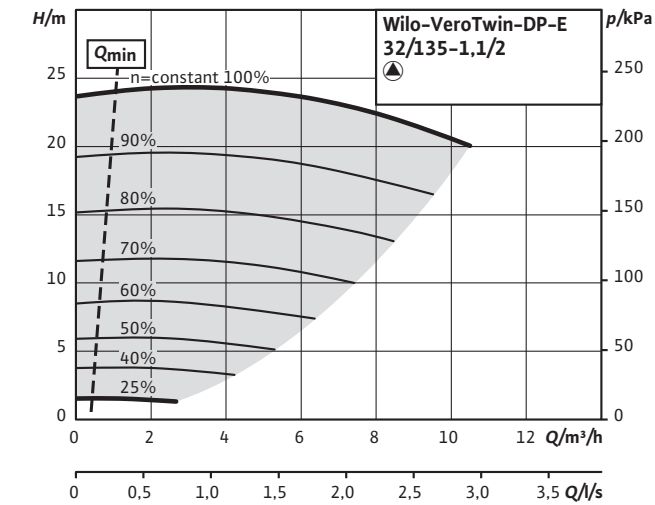

Curve caratteristiche

Verotwin-DP-E 32/135-1,1/2 (Funzionamento parallelo)

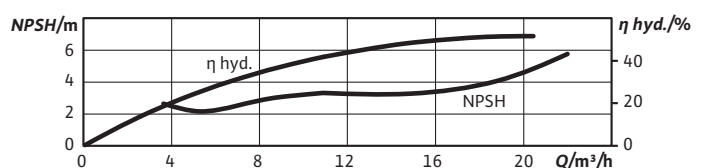
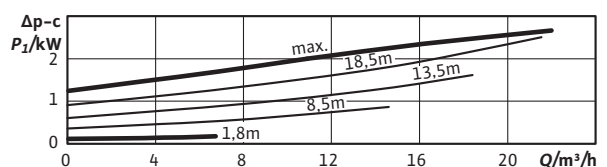
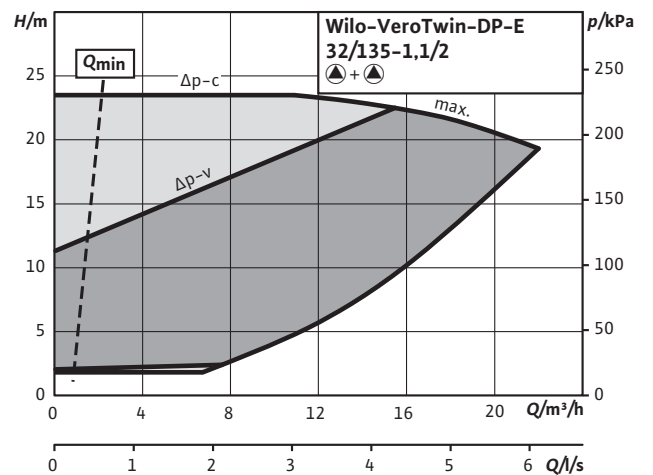
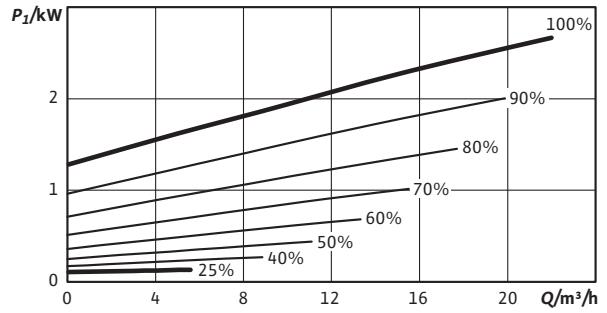
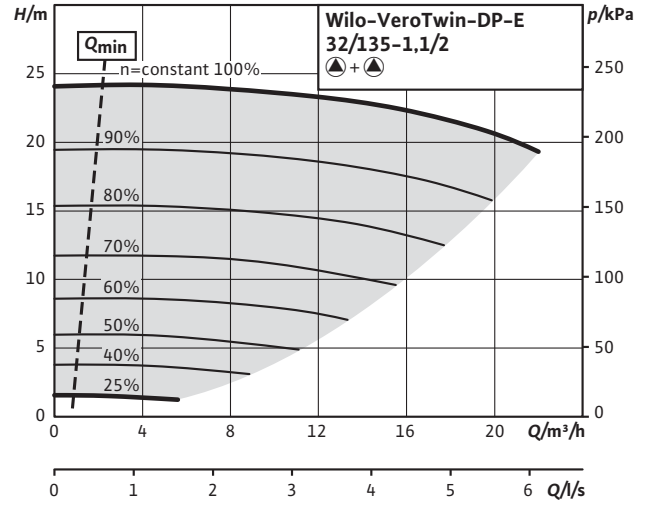

Riscaldamento, condizionamento e refrigerazione

Curve caratteristiche

Verotwin-DP-E 32/135-1,5/2 (Funzionamento singolo)

Curve caratteristiche

Verotwin-DP-E 32/135-1,5/2 (Funzionamento parallelo)

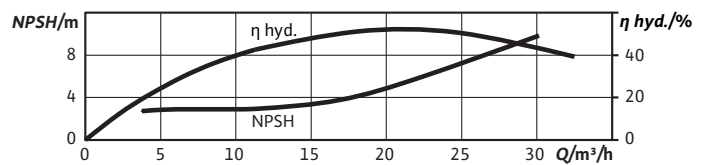
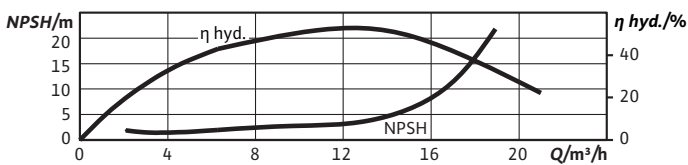
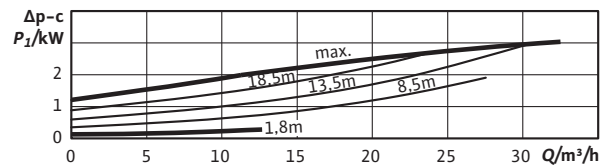
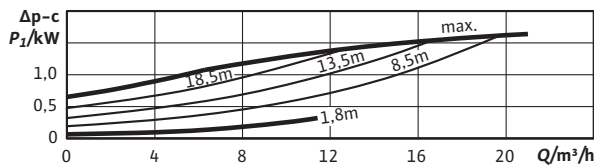
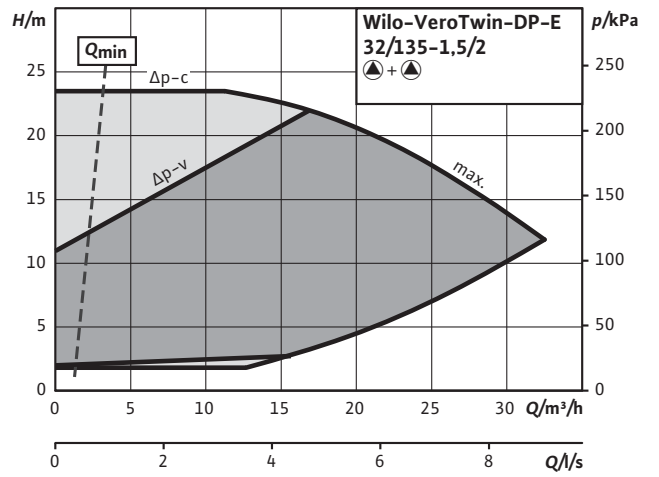
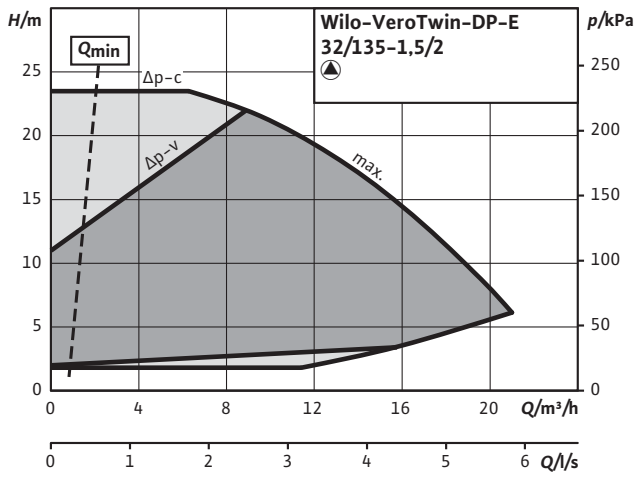
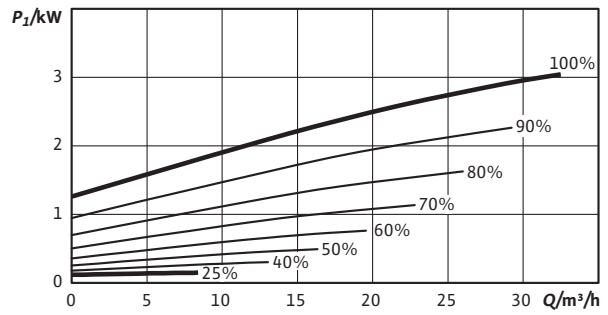
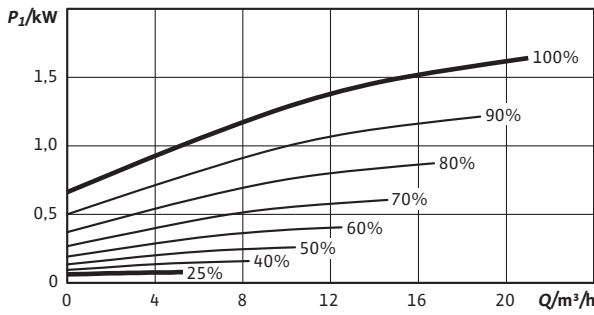
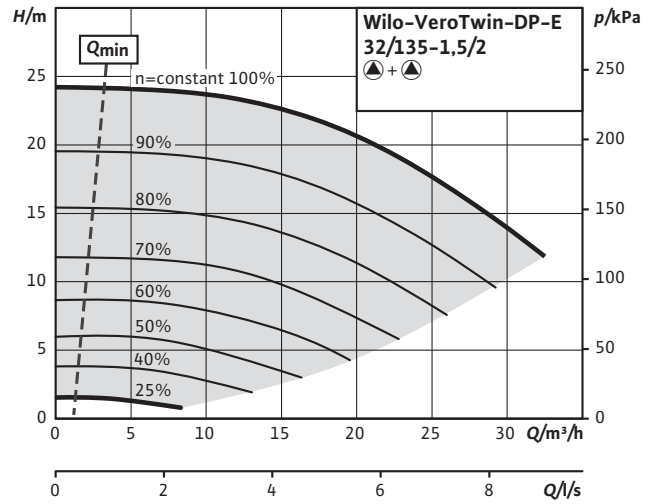
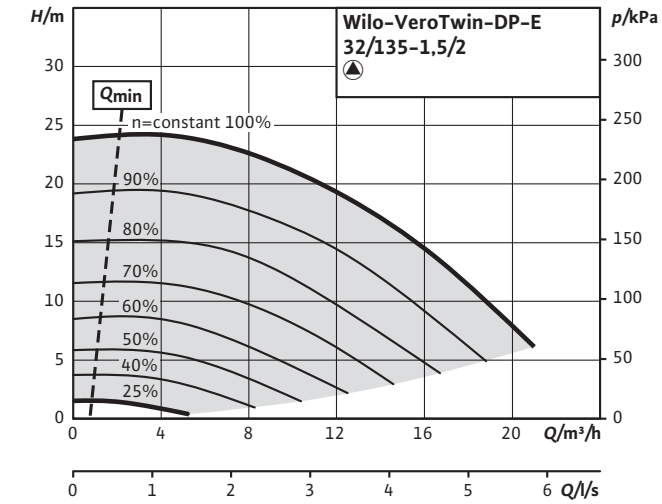

Curve caratteristiche

Verotwin-DP-E 40/115-0,55/2 (Funzionamento singolo)

Curve caratteristiche

Verotwin-DP-E 40/115-0,55/2 (Funzionamento parallelo)

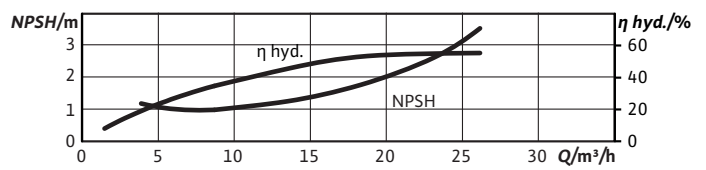
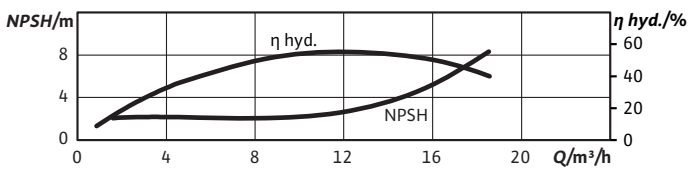
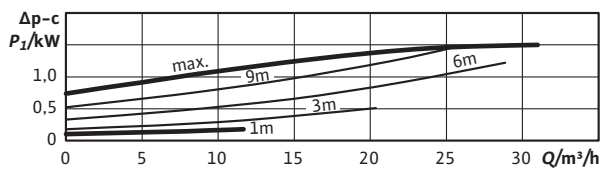
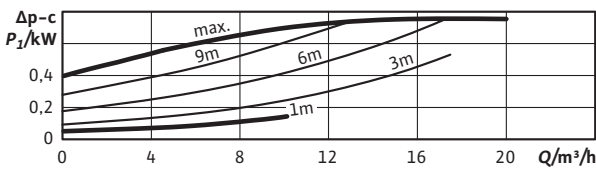
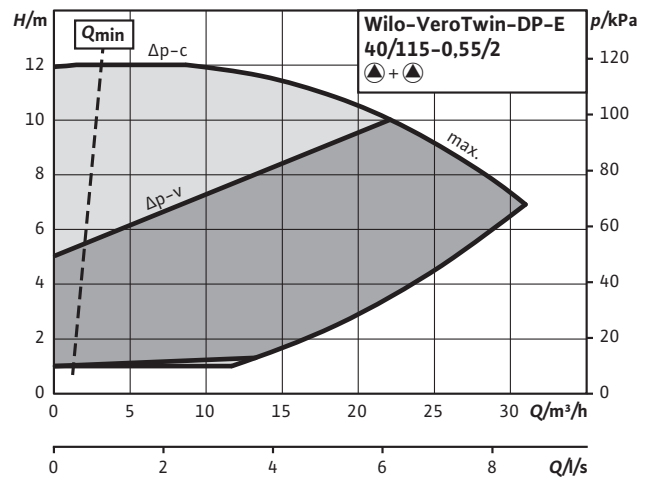
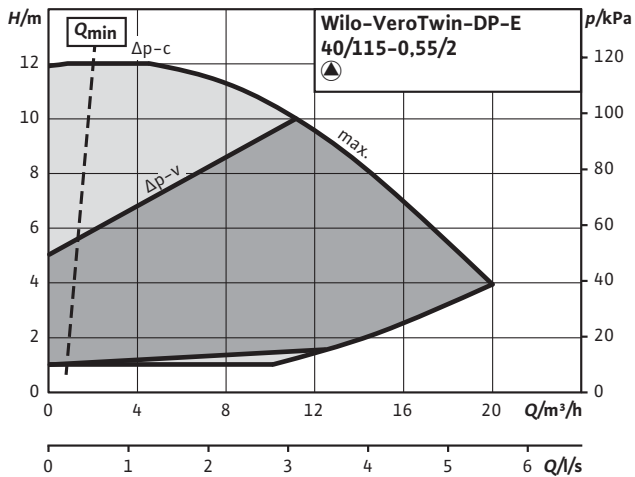
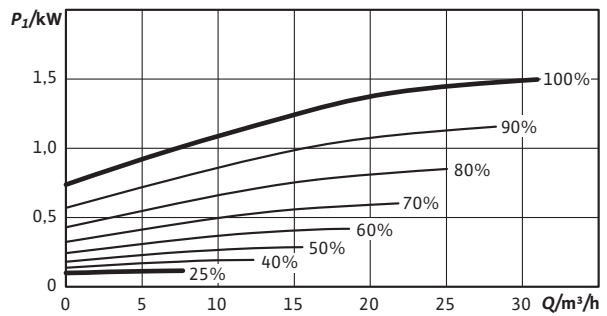
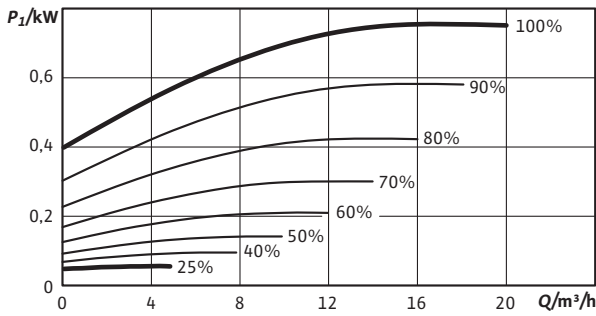
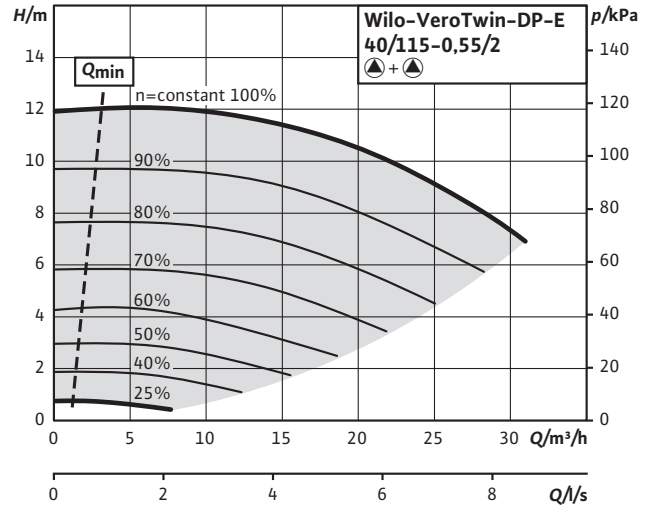
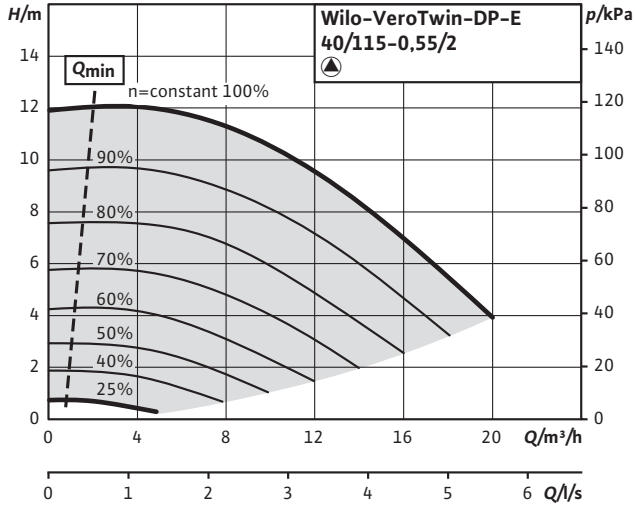

Riscaldamento, condizionamento e refrigerazione

Curve caratteristiche

VeroTwin-DP-E 40/120-1,5/2 (Funzionamento singolo)

Curve caratteristiche

VeroTwin-DP-E 40/120-1,5/2 (Funzionamento parallelo)

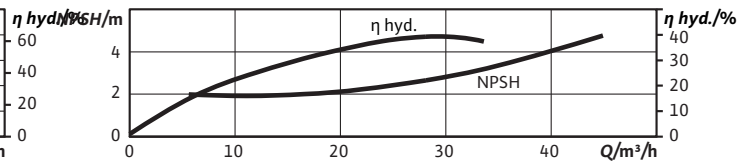
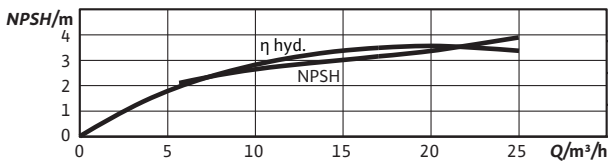
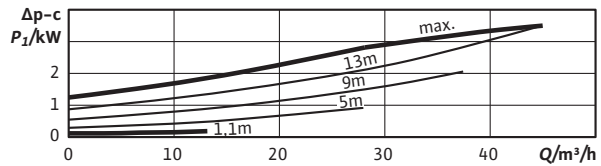
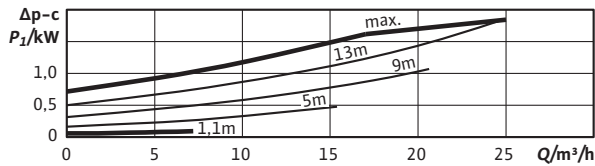
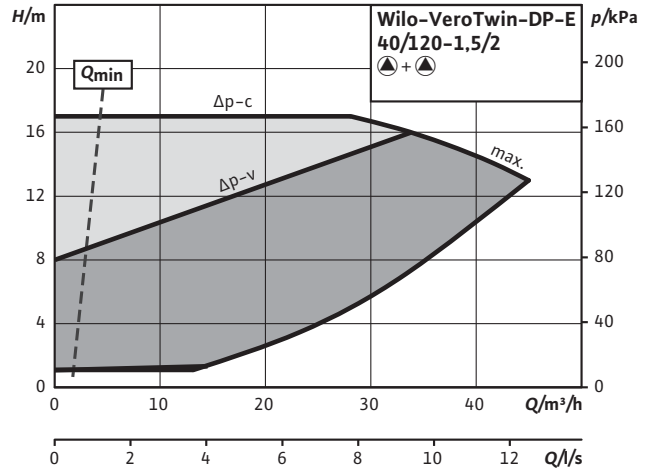
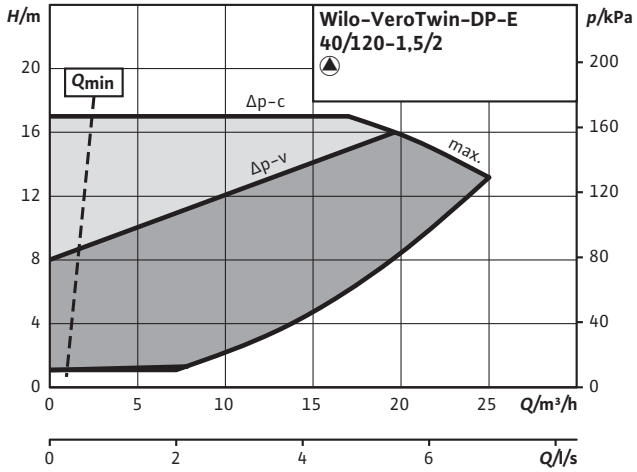
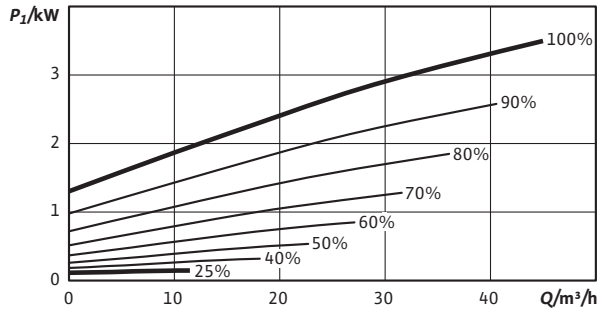
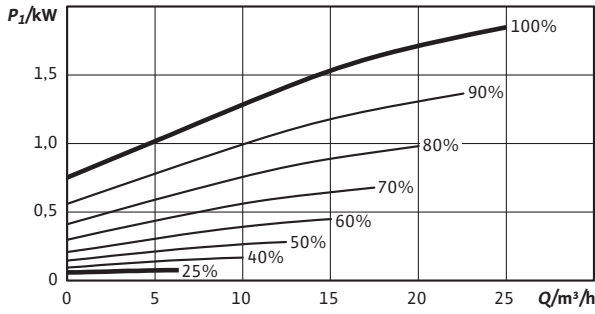
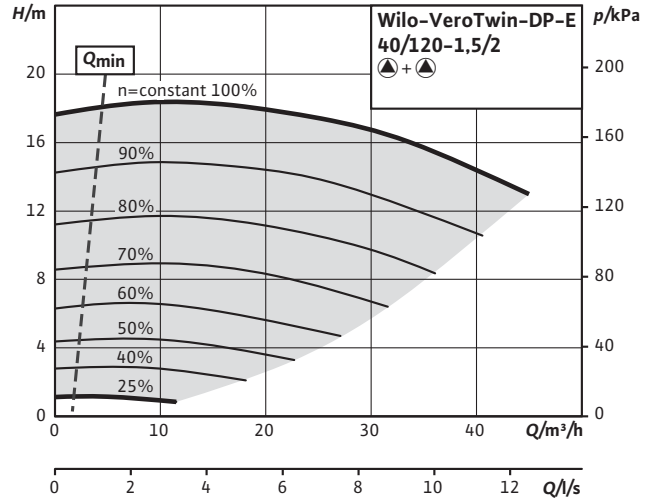
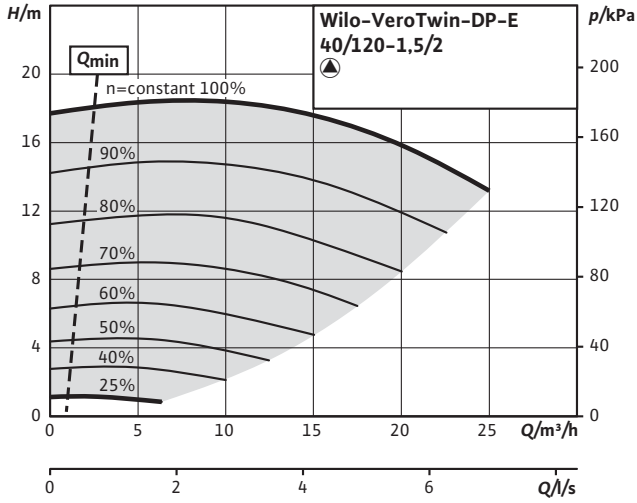



Curve caratteristiche

Verotwin-DP-E 40/130-2,2/2 (Funzionamento singolo)

Curve caratteristiche

Verotwin-DP-E 40/130-2,2/2 (Funzionamento parallelo)

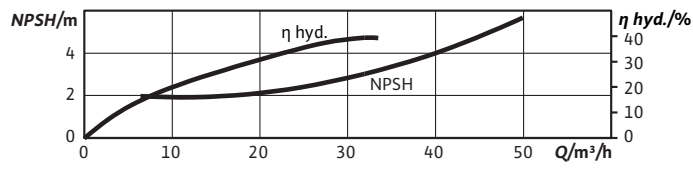
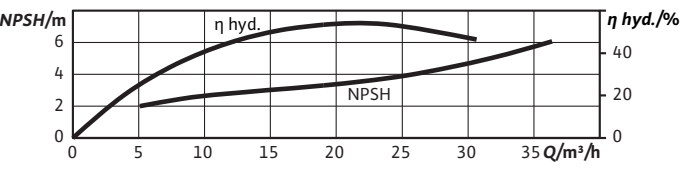
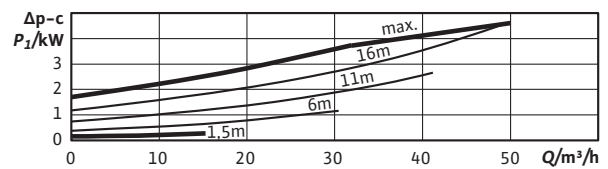
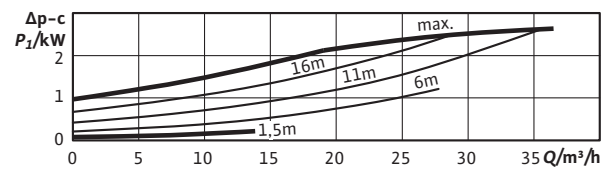
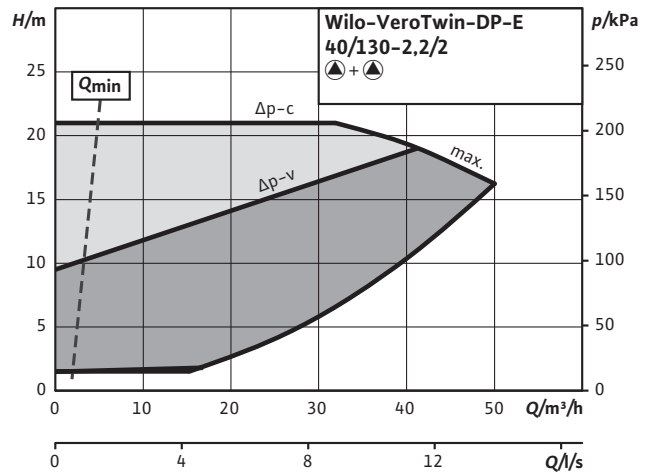
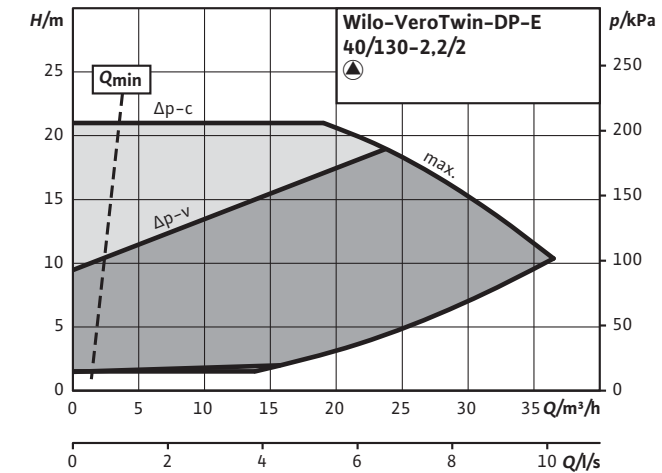
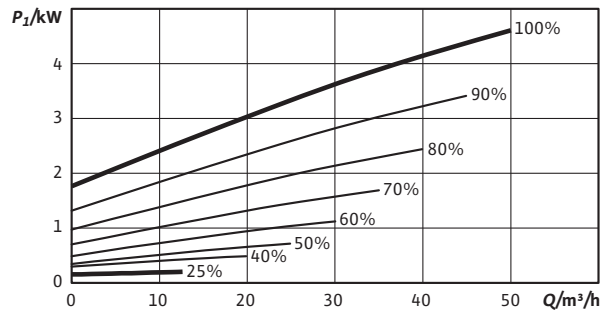
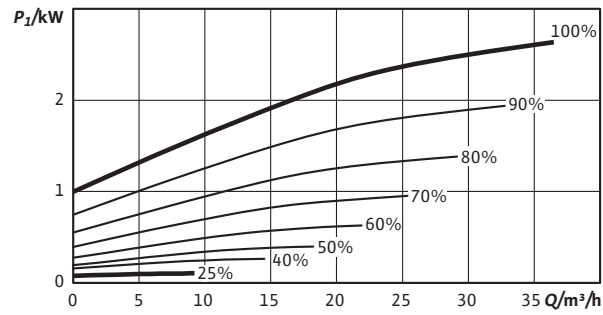
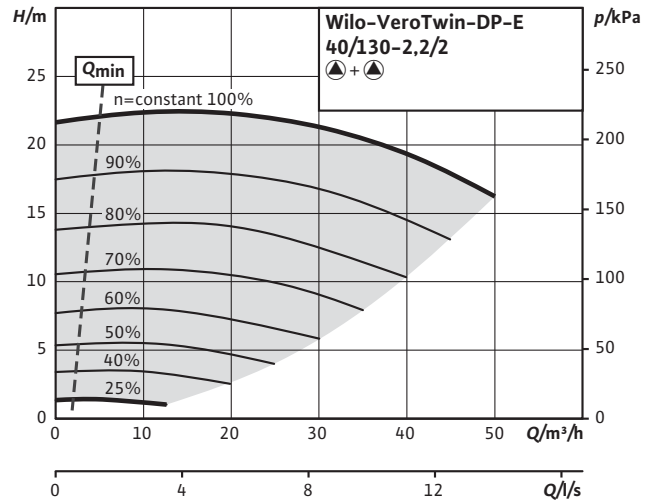
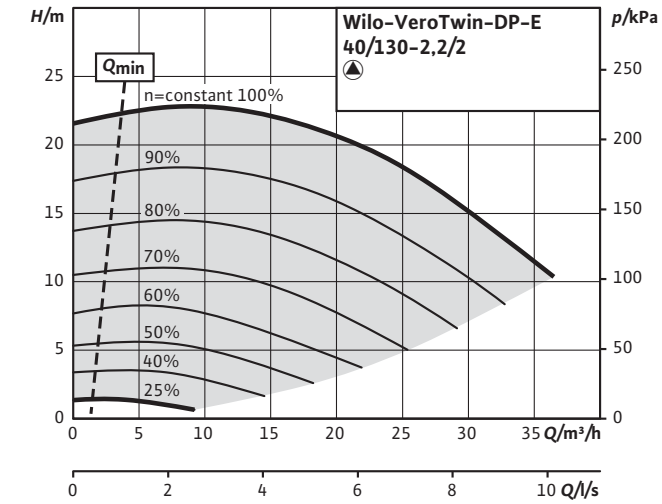

Riscaldamento, condizionamento e refrigerazione

Curve caratteristiche

Verotwin-DP-E 40/150-3/2 (Funzionamento singolo)

Curve caratteristiche

Verotwin-DP-E 40/150-3/2 (Funzionamento parallelo)

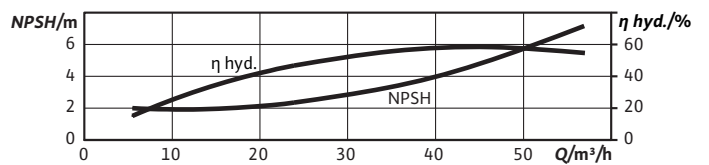
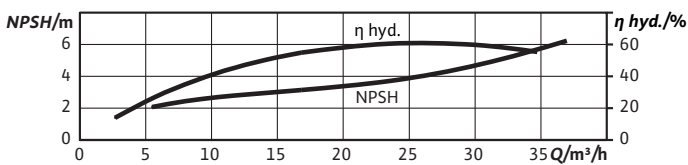
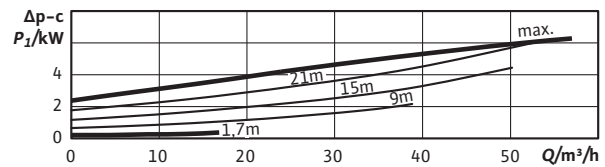
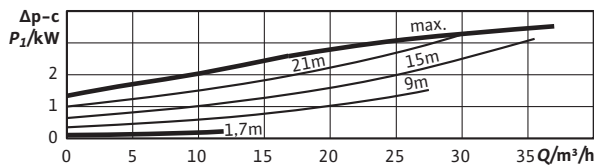
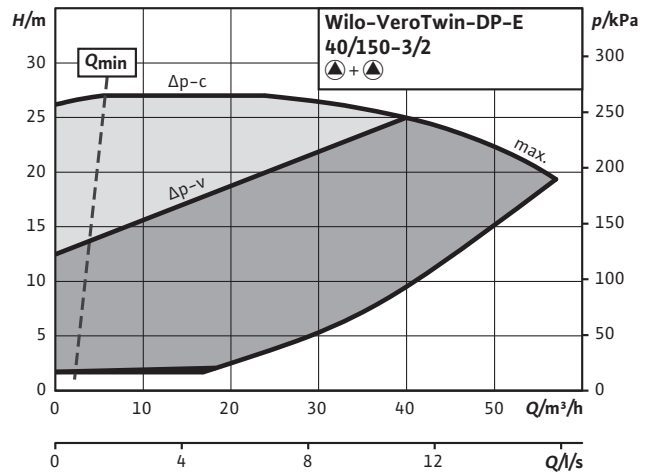
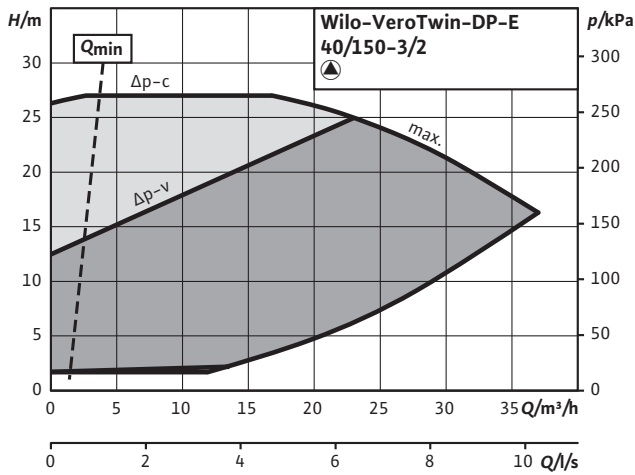
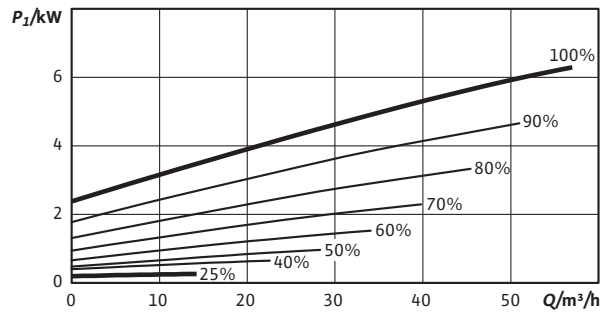
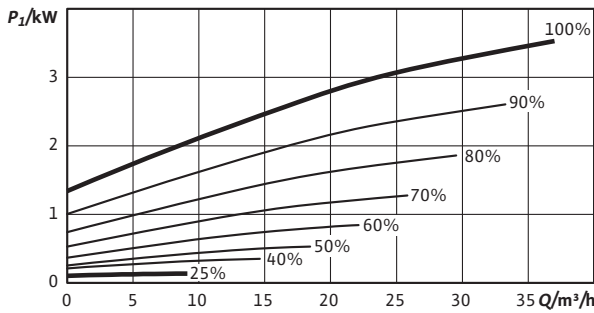
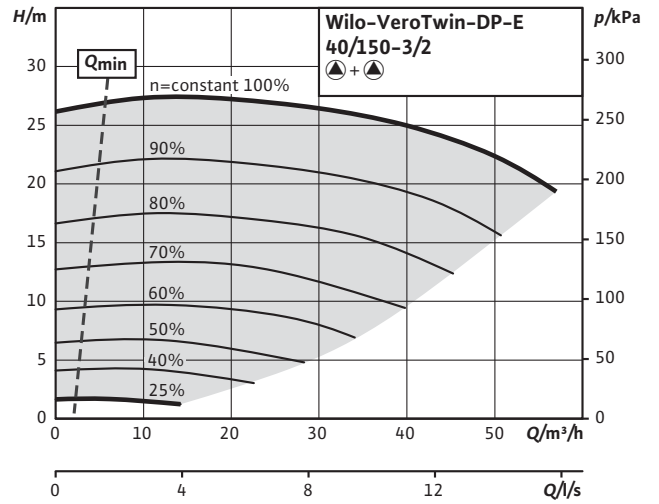
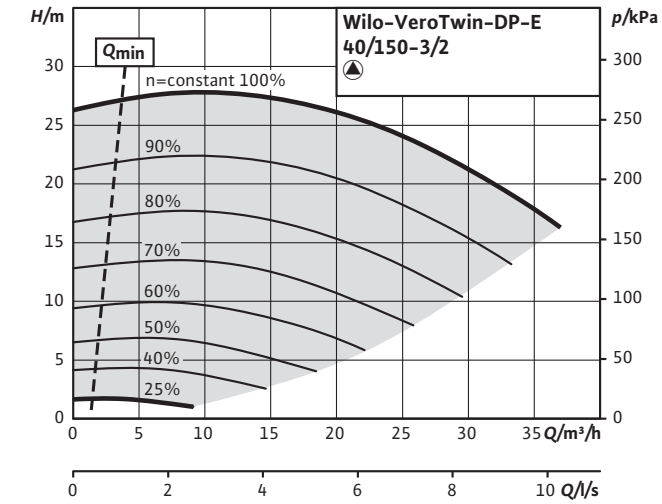

Curve caratteristiche

VeroTwin-DP-E 40/160-4/2 (Funzionamento singolo)

Curve caratteristiche

VeroTwin-DP-E 40/160-4/2 (Funzionamento parallelo)

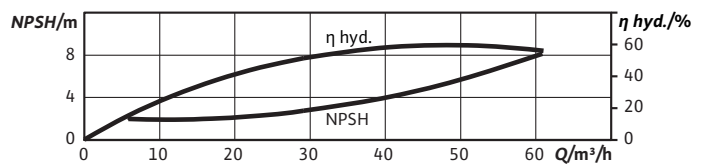
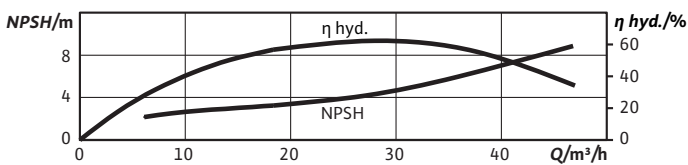
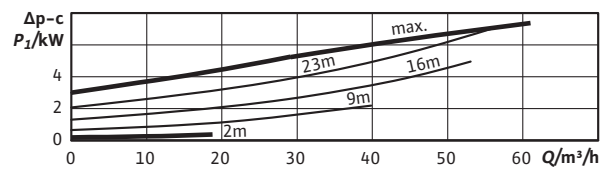
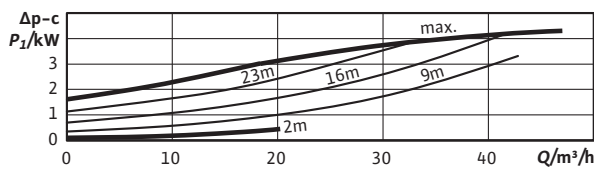
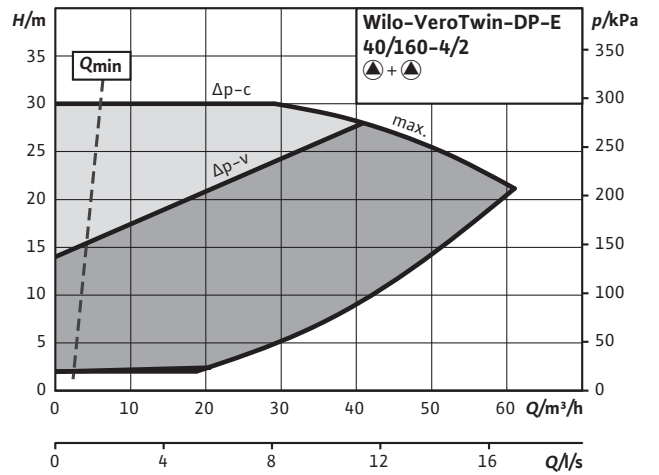
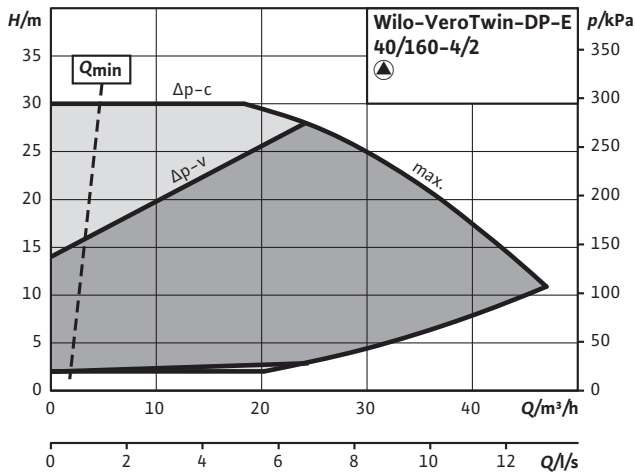
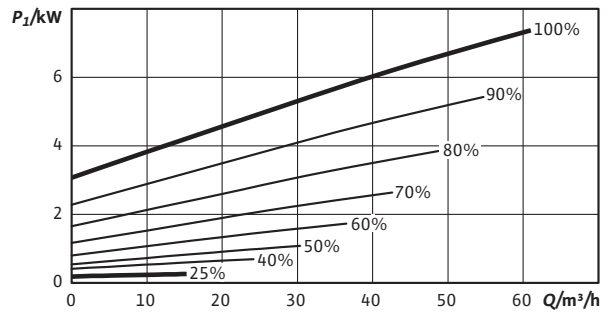
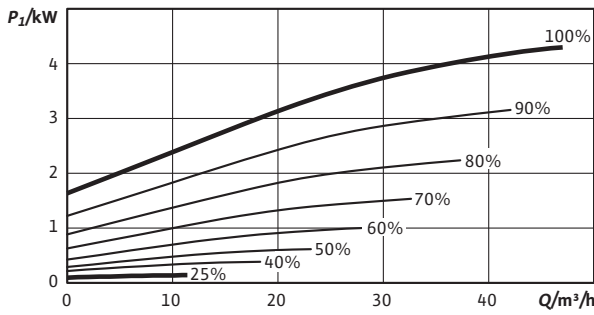
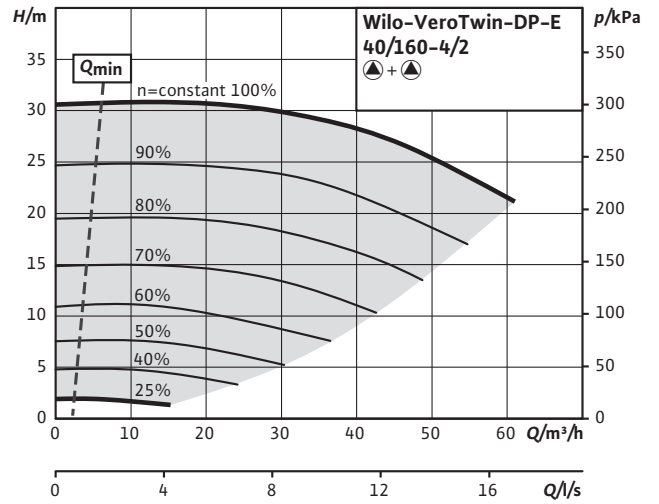
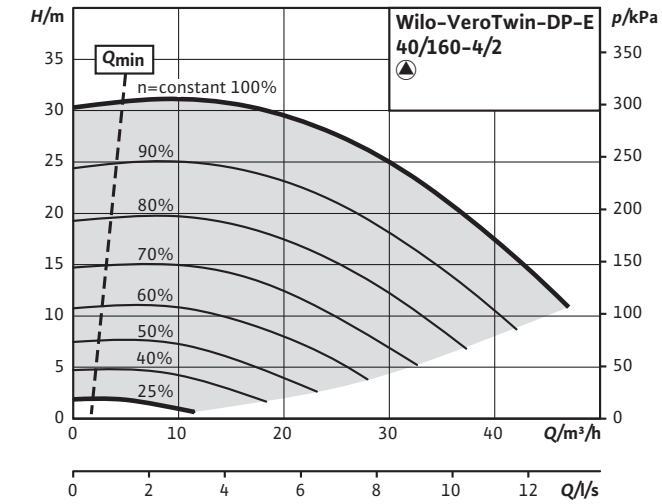

Riscaldamento, condizionamento e refrigerazione

Curve caratteristiche

Verotwin-DP-E 50/105-0,72/2 (Funzionamento singolo)

Curve caratteristiche

Verotwin-DP-E 50/105-0,72/2 (Funzionamento parallelo)

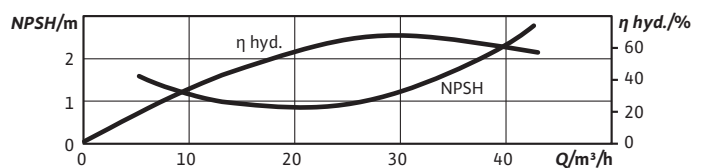
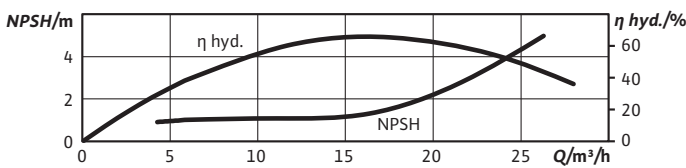
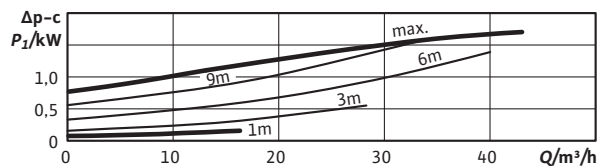
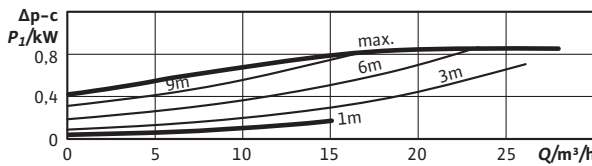
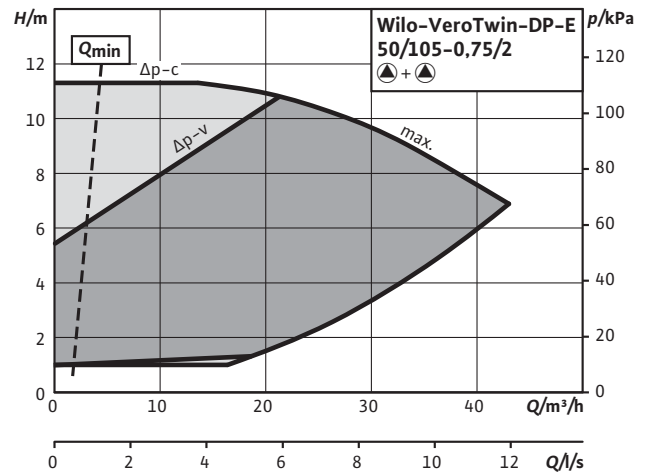
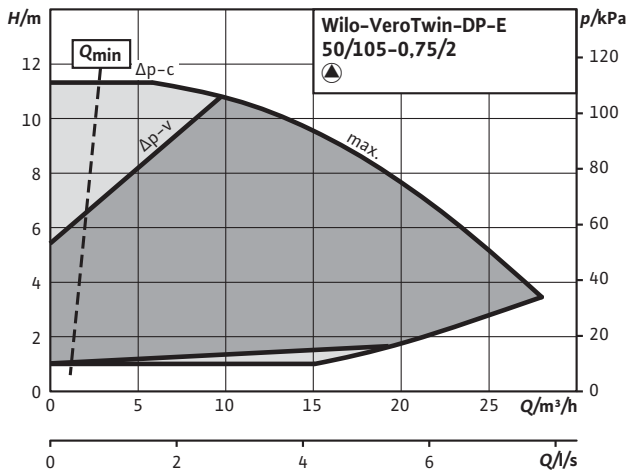
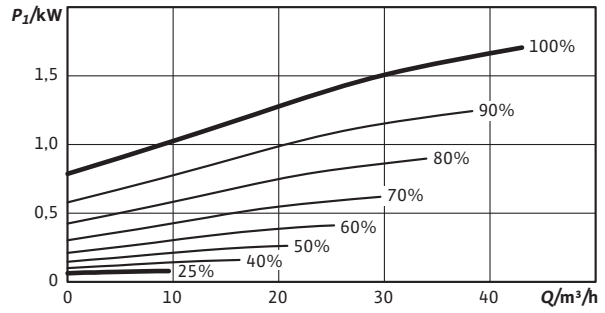
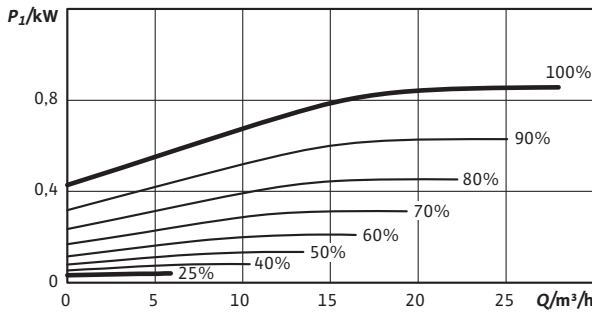
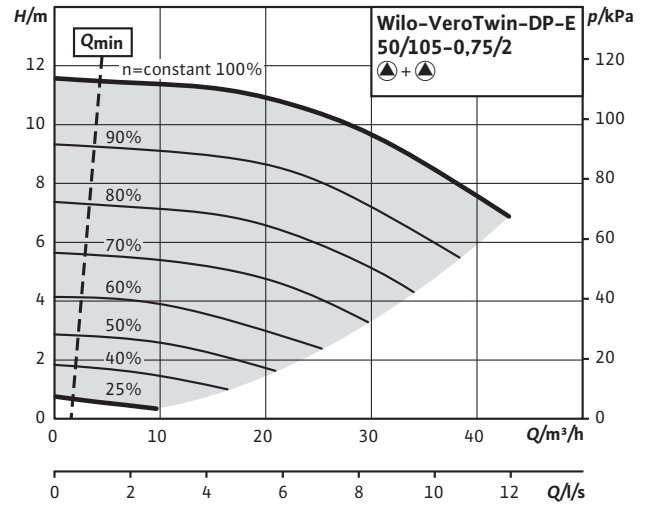
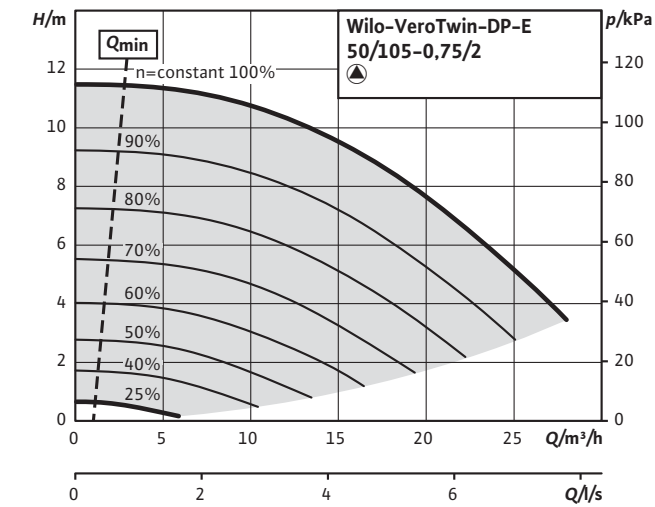

Curve caratteristiche

Verotwin-DP-E 50/130-2,2/2 (Funzionamento singolo)

Curve caratteristiche

Verotwin-DP-E 50/130-2,2/2 (Funzionamento parallelo)

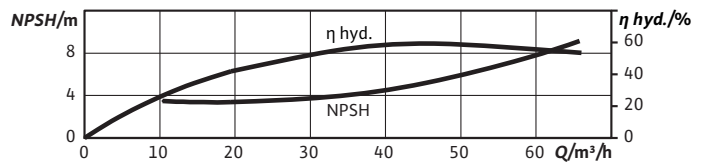
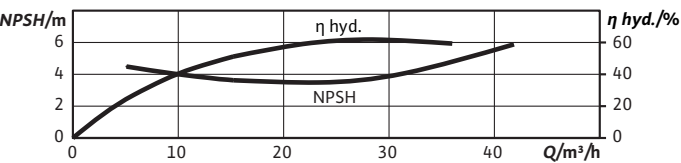
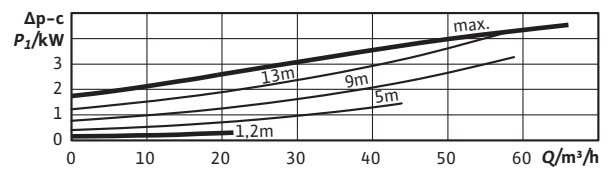
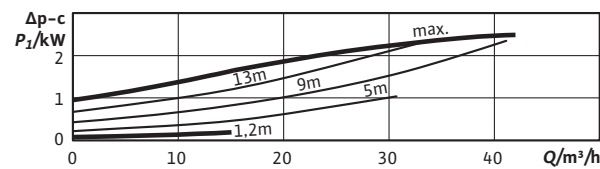
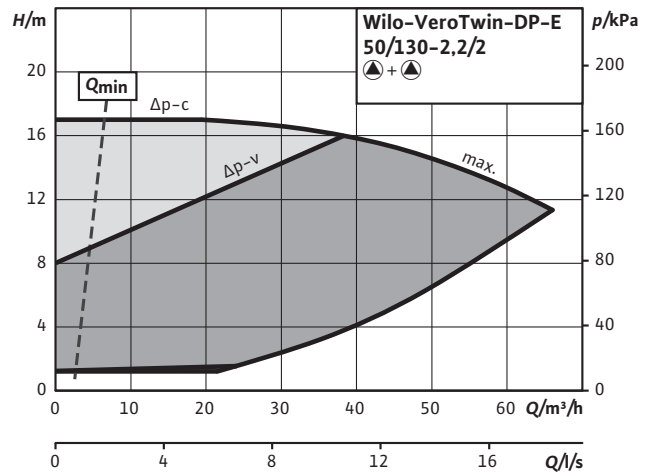
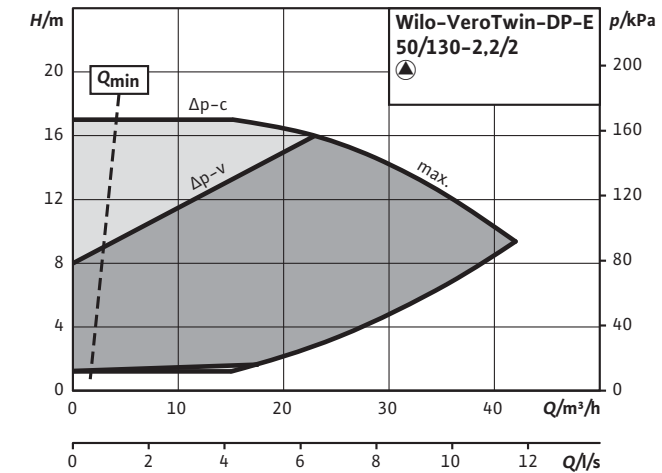
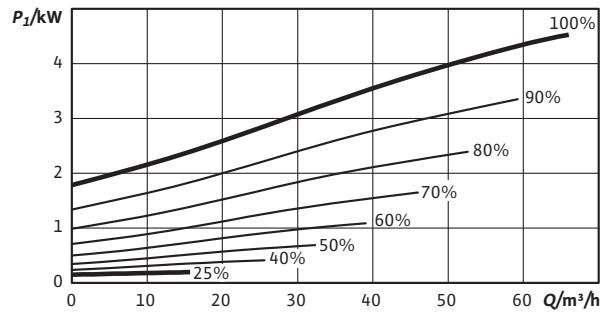
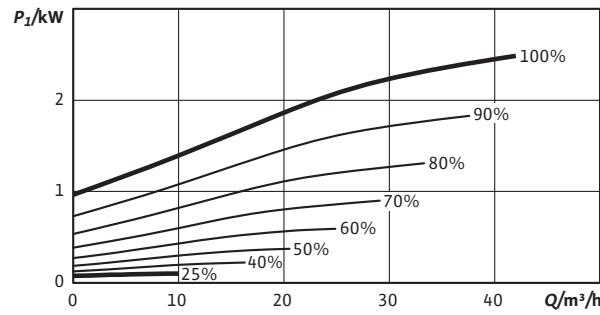
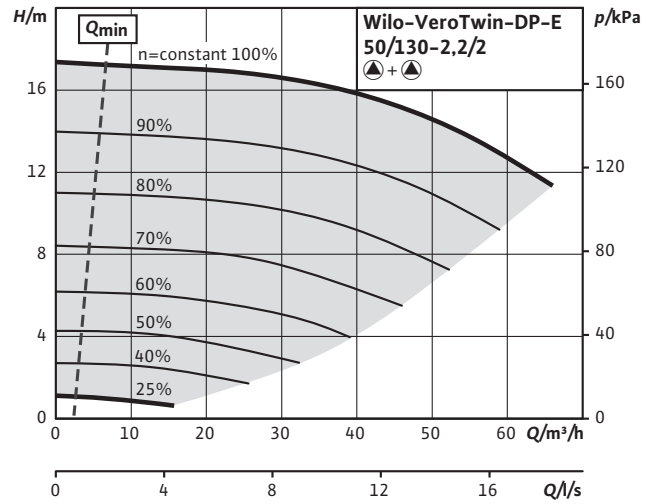
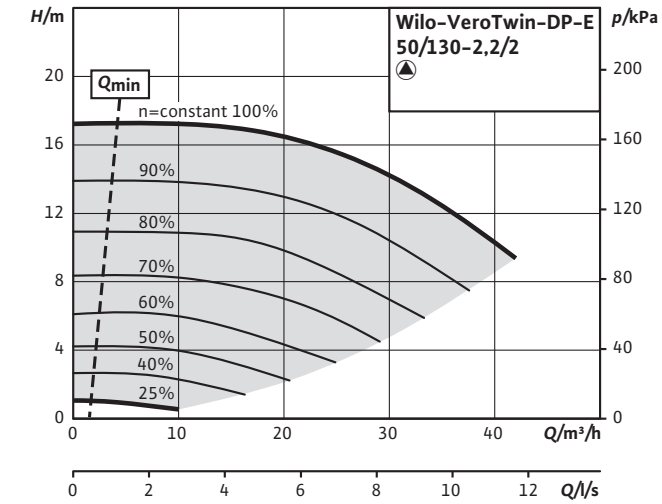

Riscaldamento, condizionamento e refrigerazione

Curve caratteristiche

Verotwin-DP-E 50/140-3/2 (Funzionamento singolo)

Curve caratteristiche

Verotwin-DP-E 50/140-3/2 (Funzionamento parallelo)

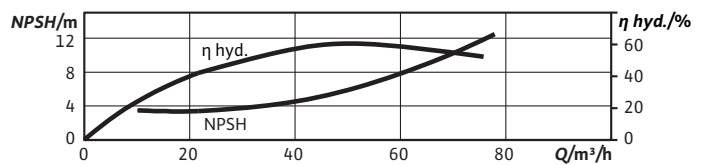
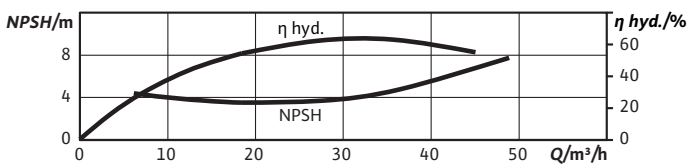
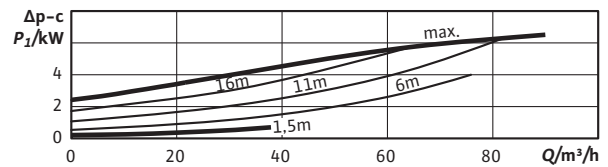
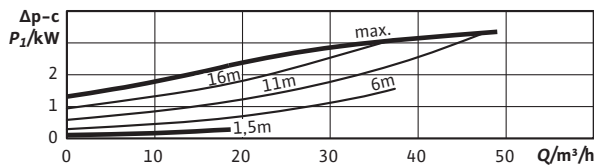
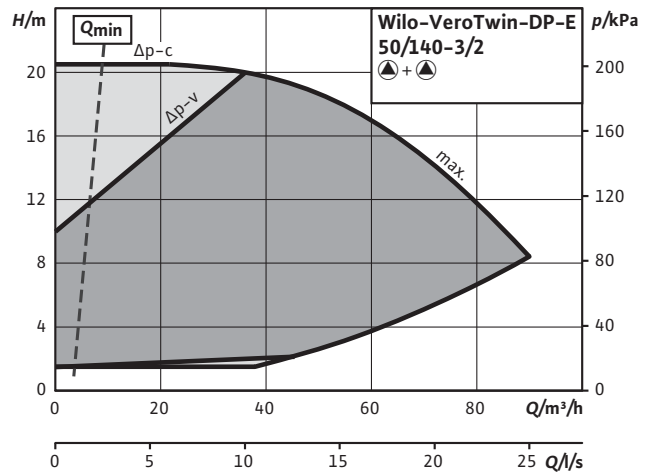
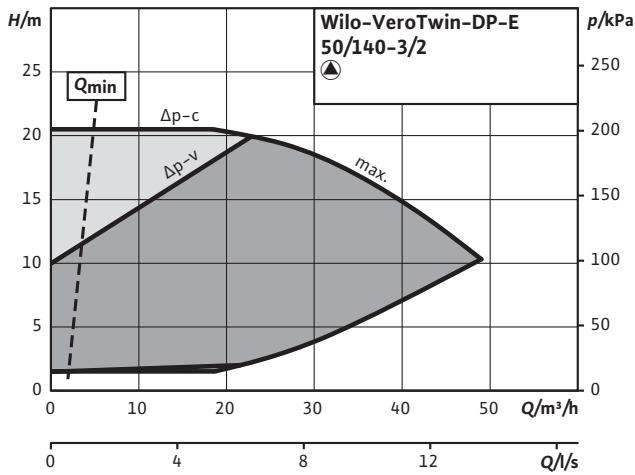
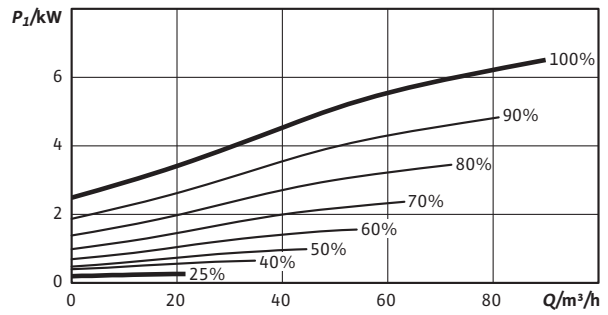
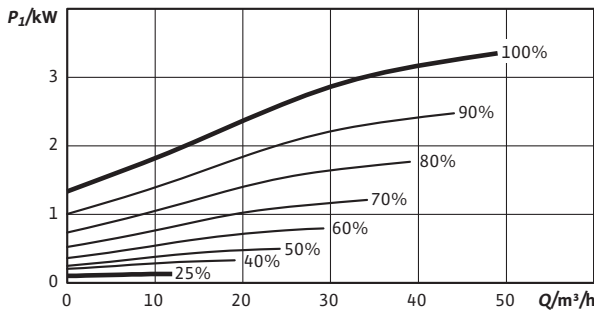
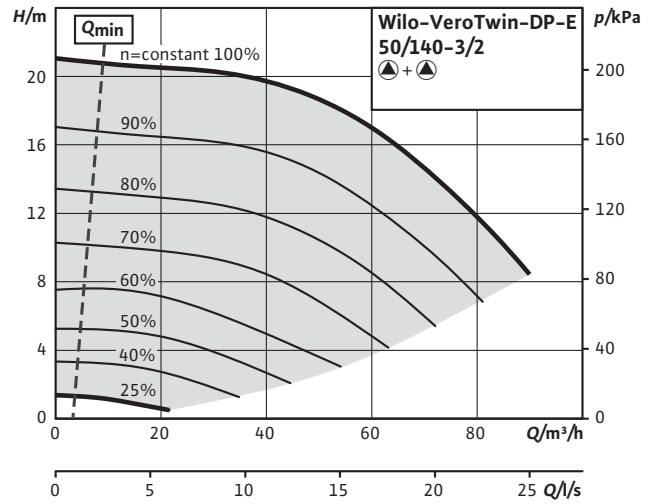
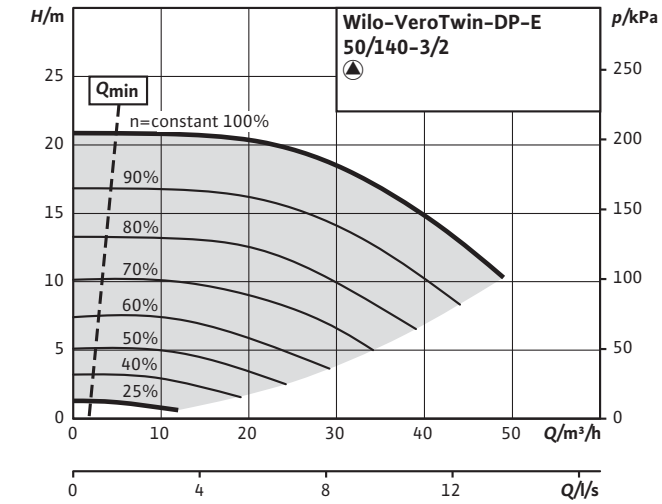

Curve caratteristiche

Verotwin-DP-E 50/150-4/2 (Funzionamento singolo)

Curve caratteristiche

Verotwin-DP-E 50/150-4/2 (Funzionamento parallelo)

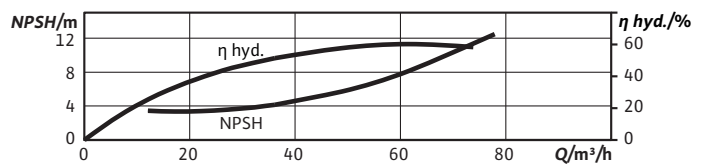
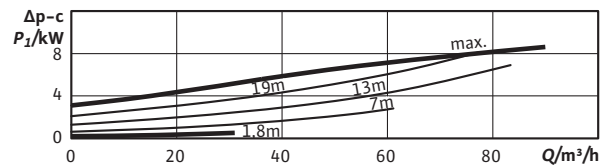
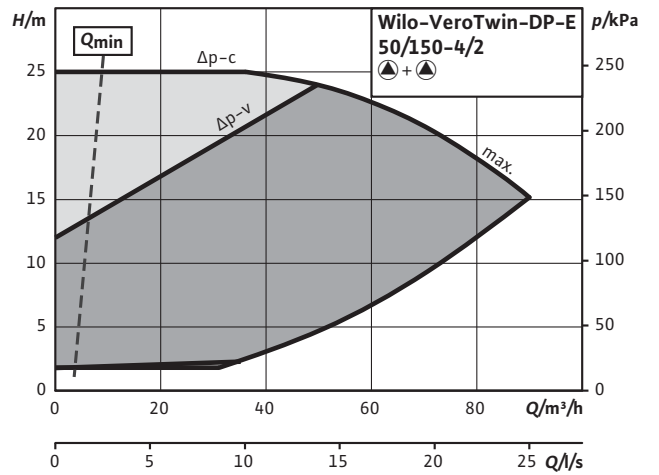
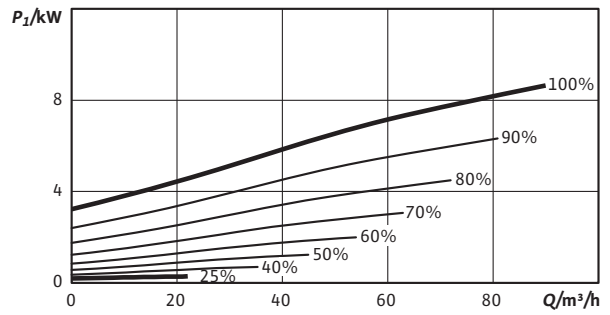
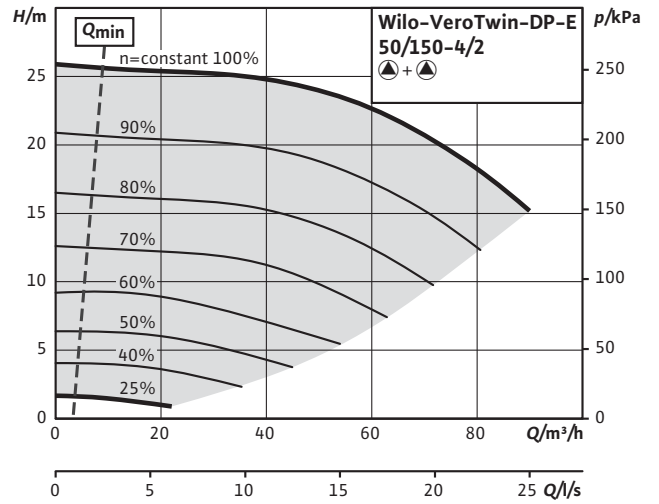
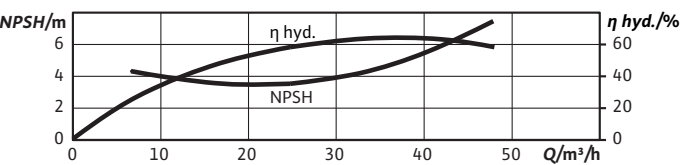
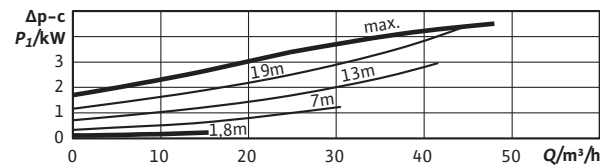
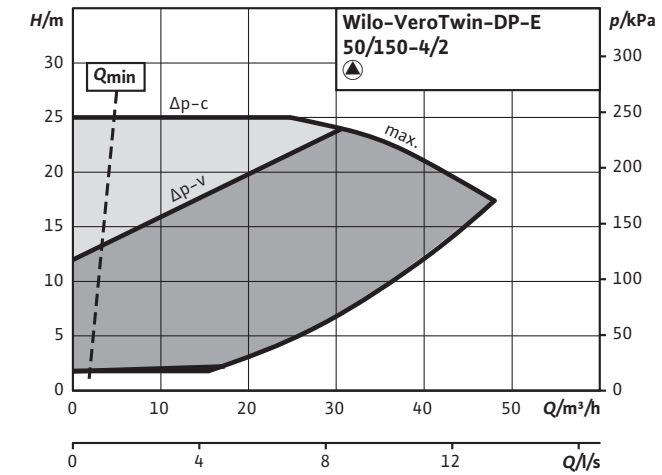
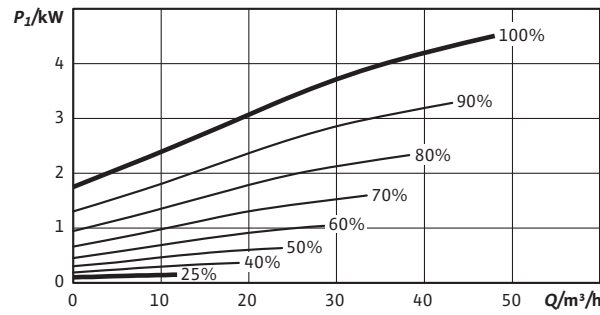
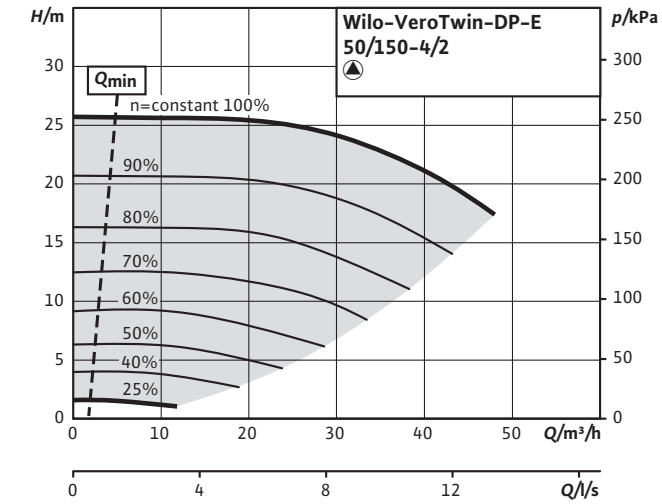

Curve caratteristiche

Verotwin-DP-E 65/115-1,5/2 (Funzionamento singolo)

Curve caratteristiche

Verotwin-DP-E 65/115-1,5/2 (Funzionamento parallelo)

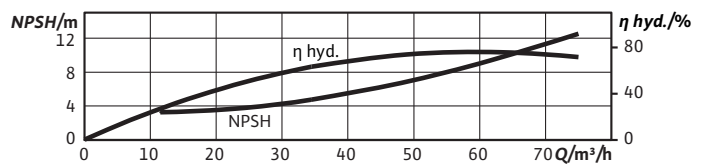
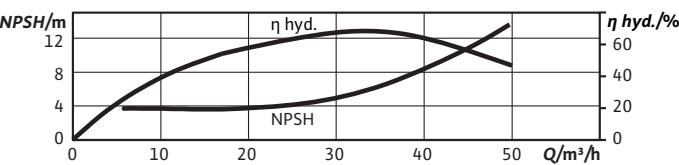
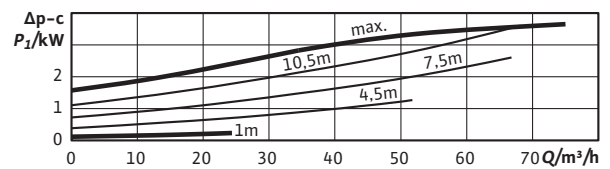
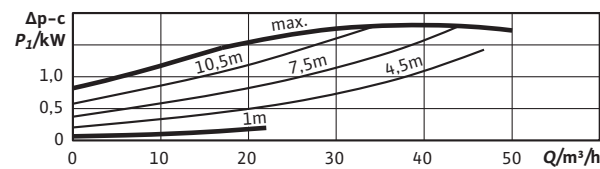
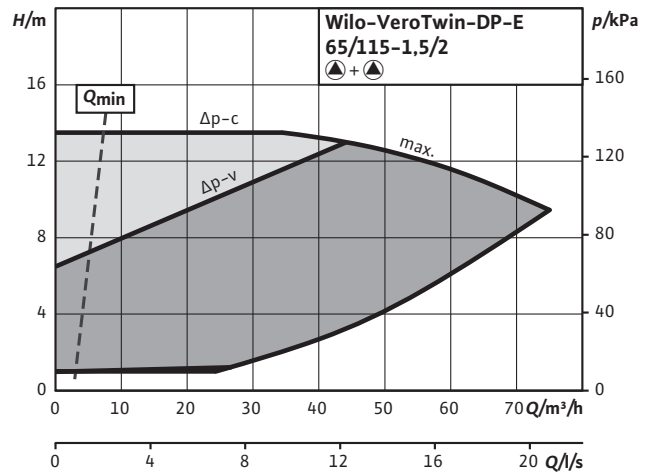
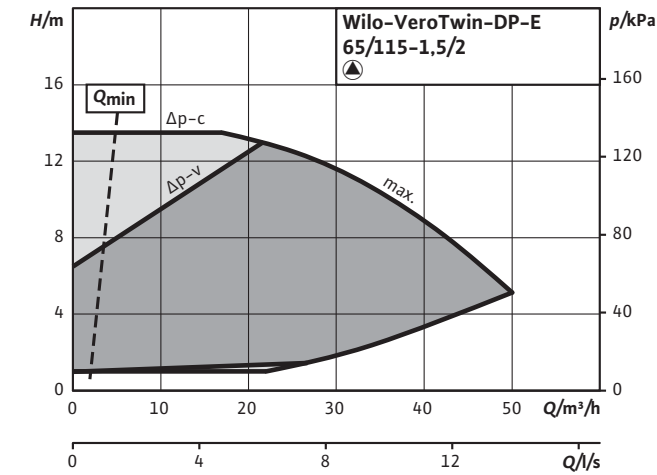
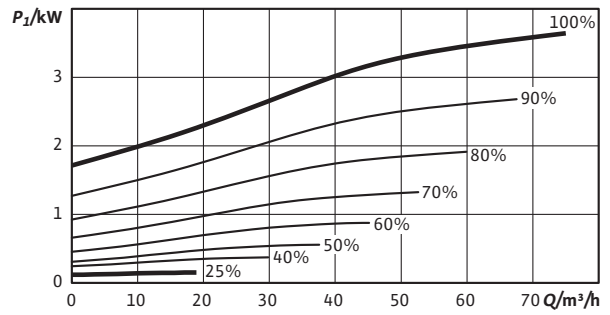
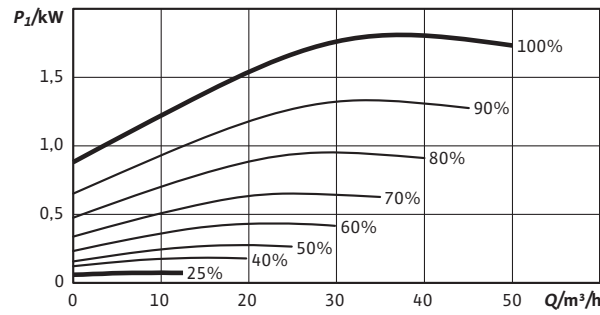
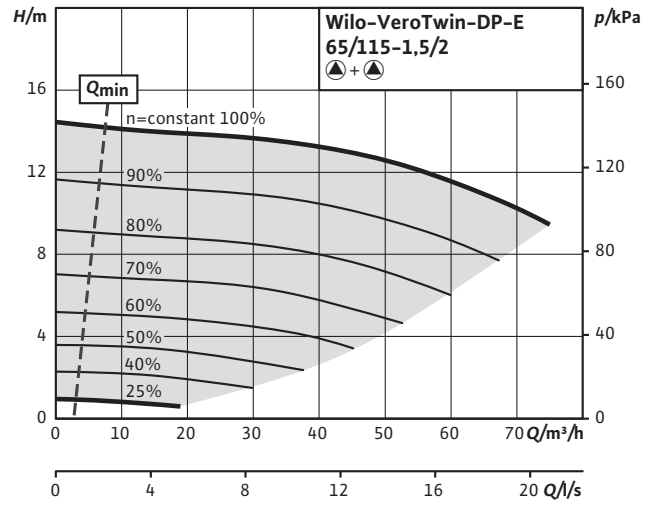
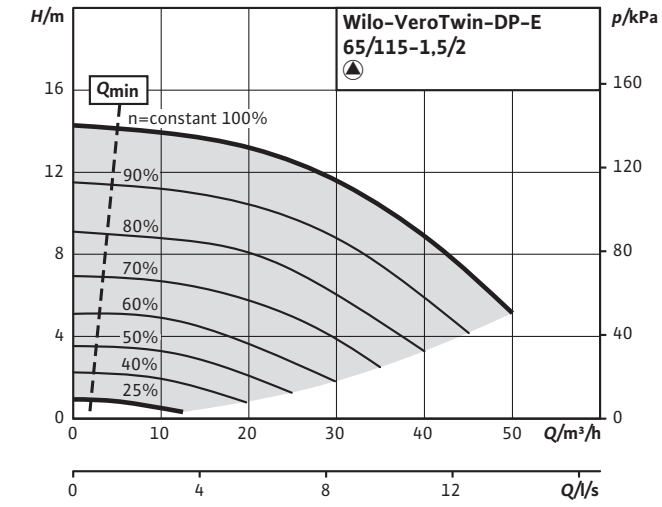



Curve caratteristiche

Verotwin-DP-E 65/110-2,2/2 (Funzionamento singolo)

Curve caratteristiche

Verotwin-DP-E 65/110-2,2/2 (Funzionamento parallelo)

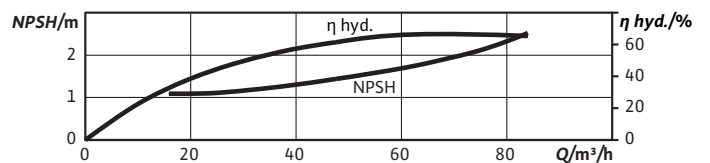
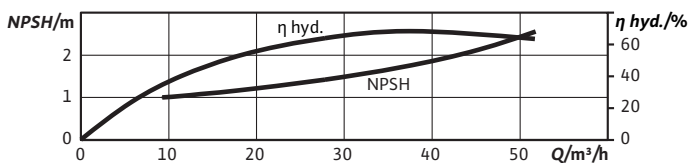
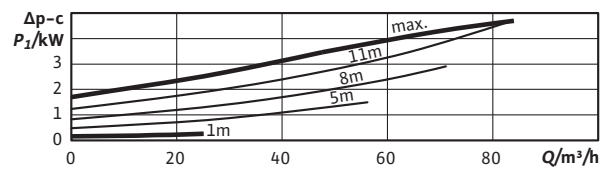
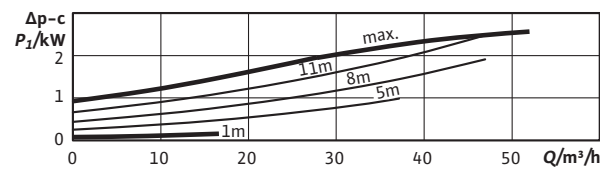
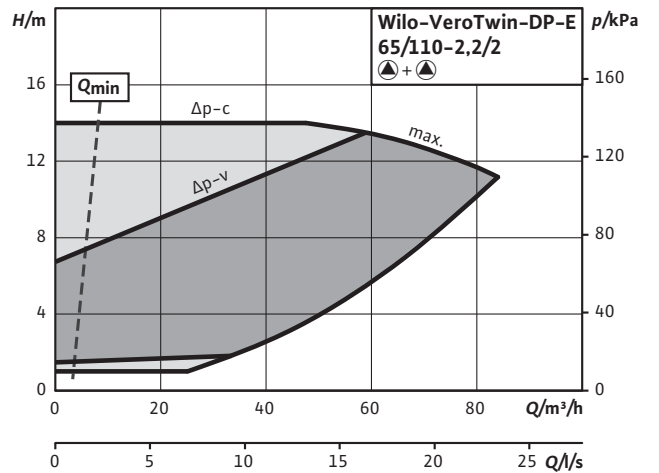
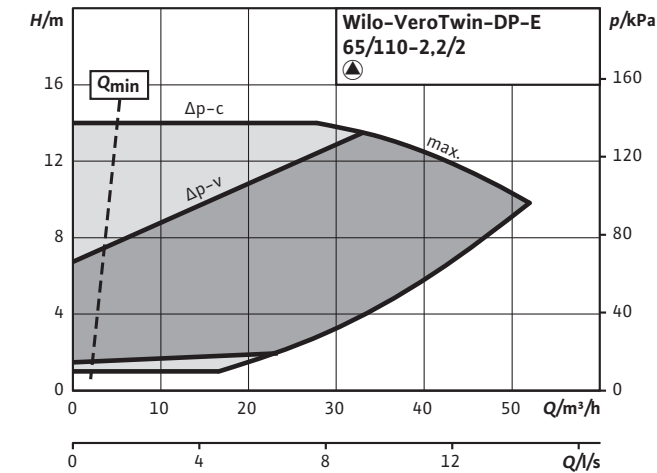
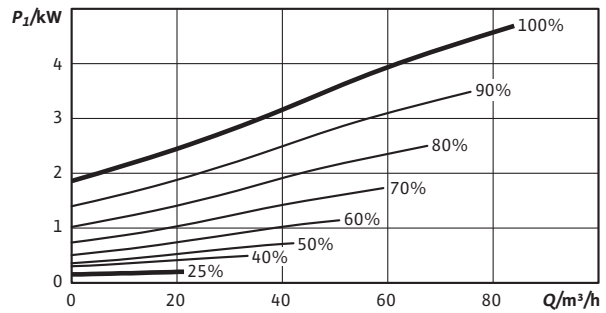
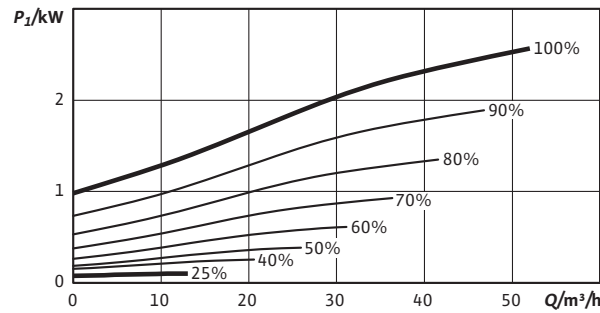
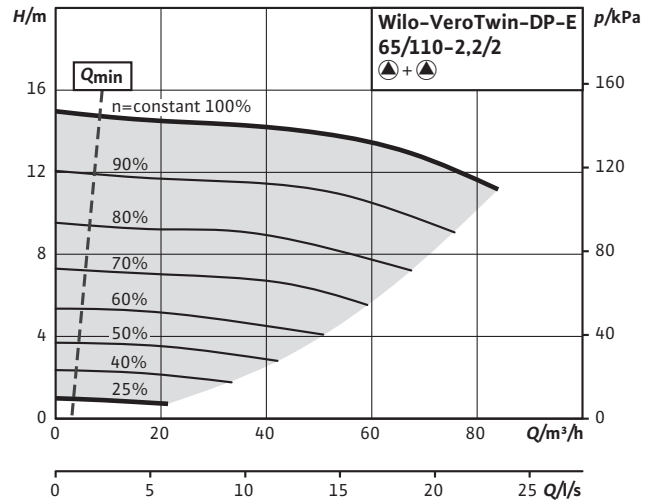
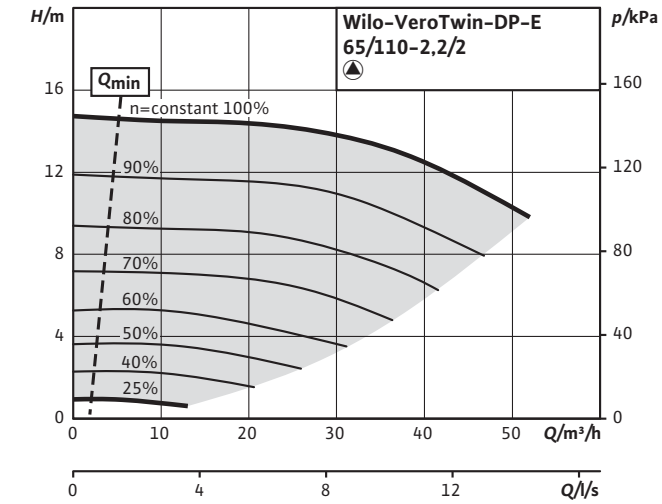

Riscaldamento, condizionamento e refrigerazione

Curve caratteristiche

Verotwin-DP-E 65/120-3/2 (Funzionamento singolo)

Curve caratteristiche

Verotwin-DP-E 65/120-3/2 (Funzionamento parallelo)

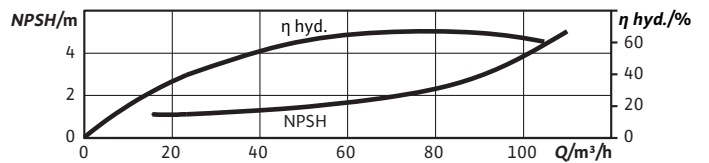
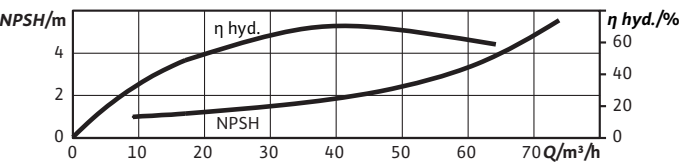
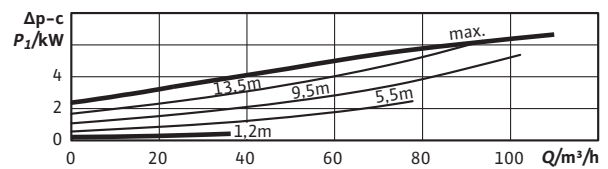
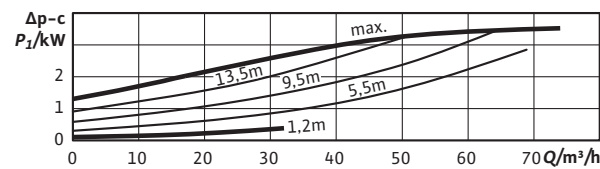
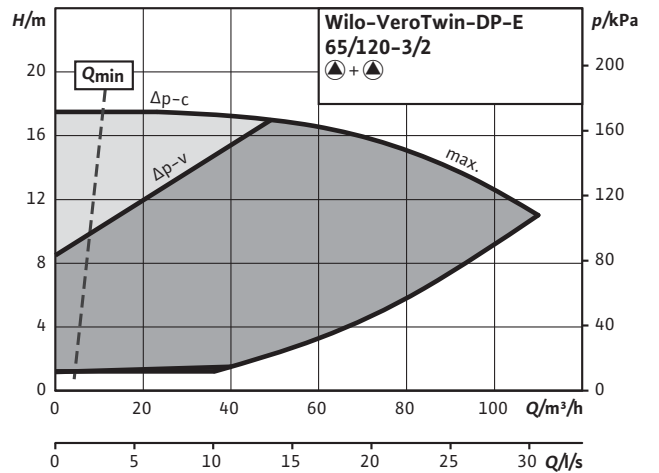
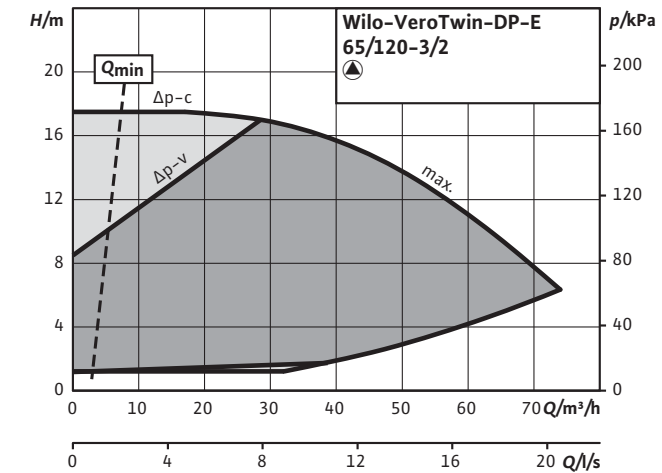
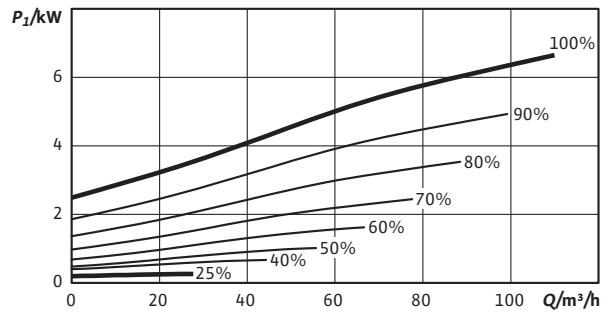
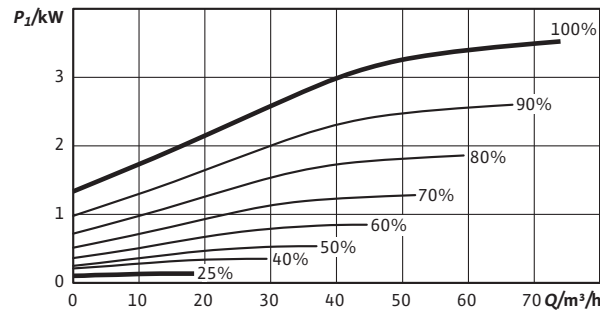
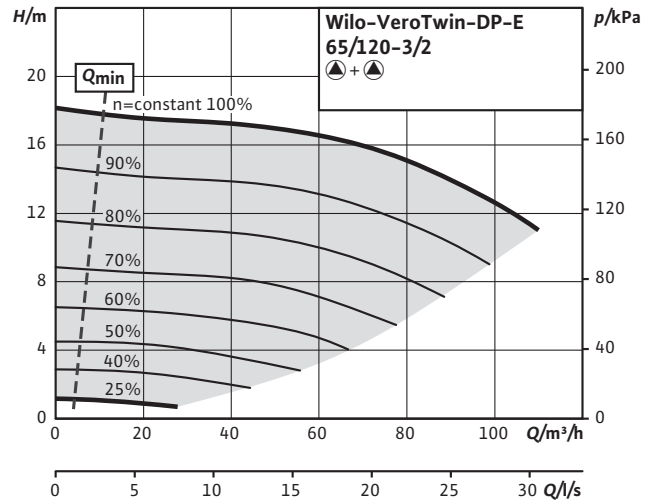
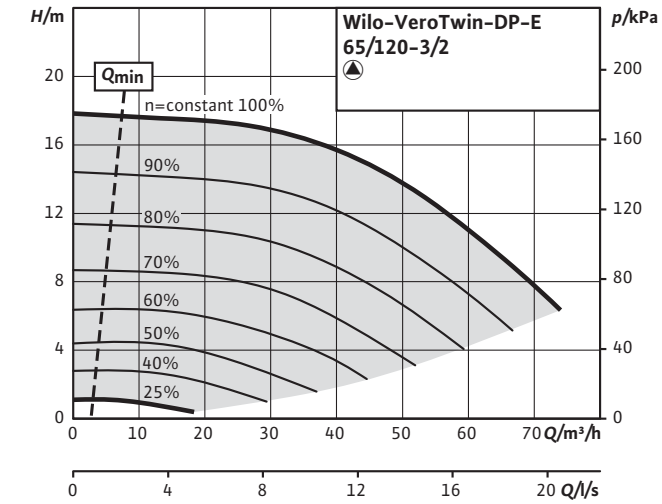

Curve caratteristiche

Verotwin-DP-E 65/130-4/2 (Funzionamento singolo)

Curve caratteristiche

Verotwin-DP-E 65/130-4/2 (Funzionamento parallelo)

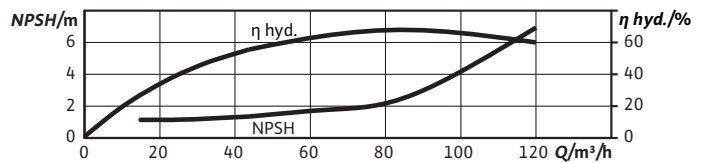
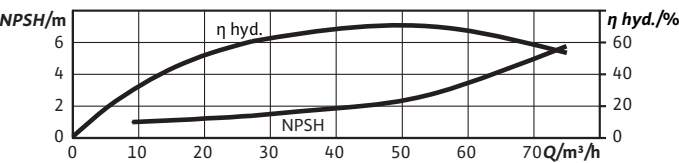
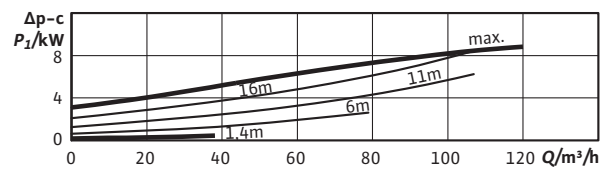
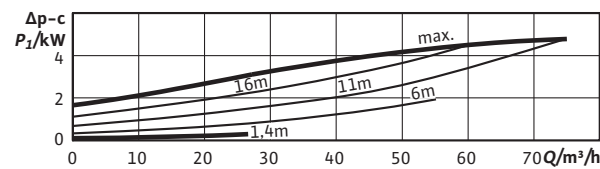
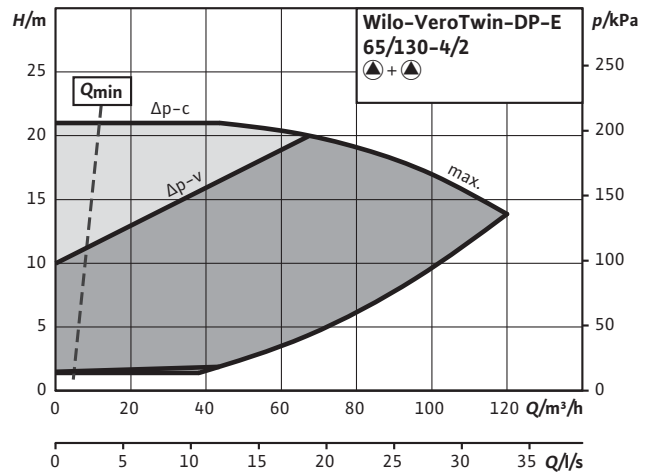
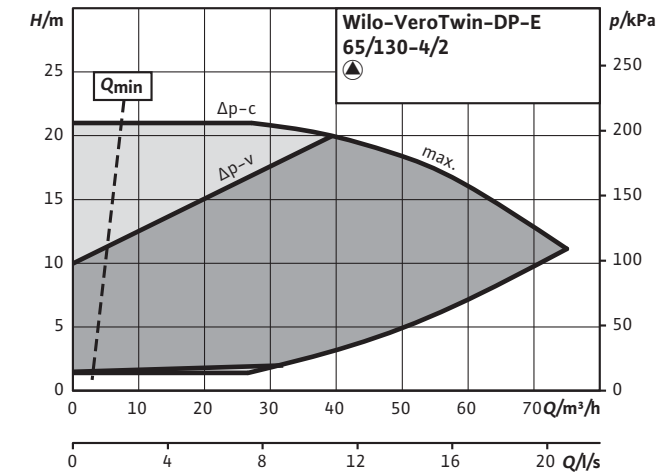
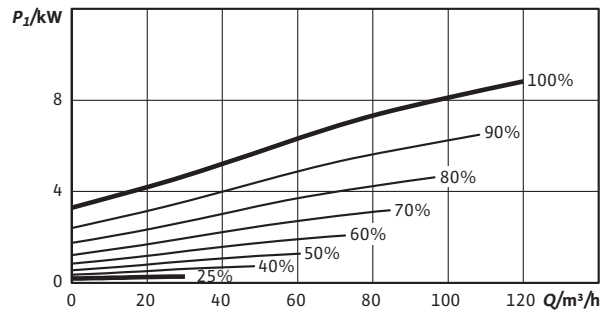
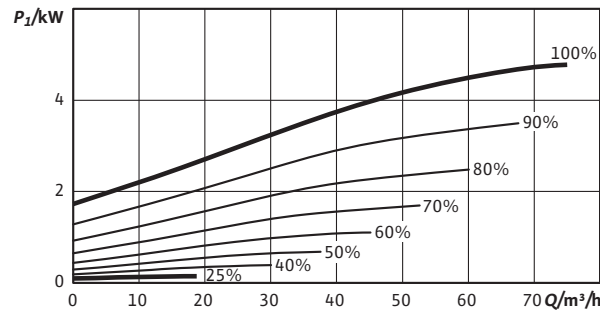
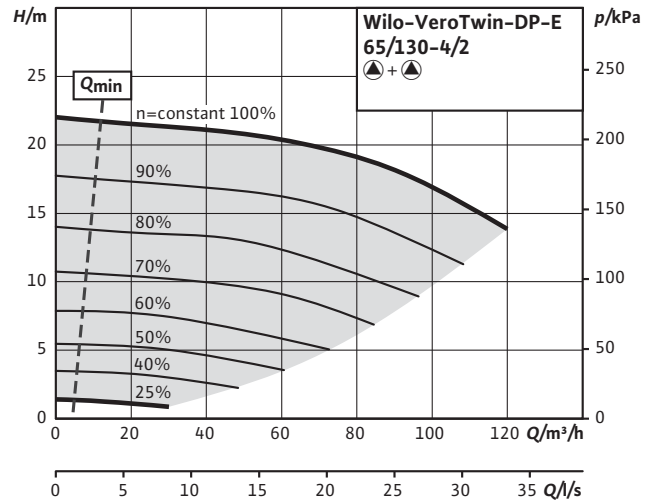
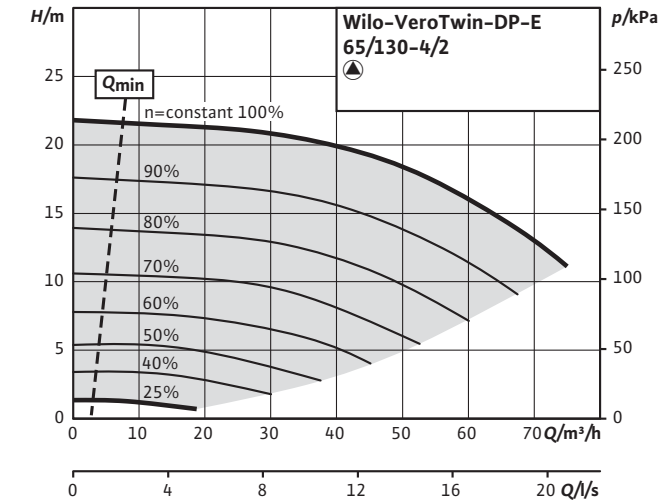

Riscaldamento, condizionamento e refrigerazione

Curve caratteristiche

Verotwin-DP-E 80/115-2,2/2 (Funzionamento singolo)

Curve caratteristiche

Verotwin-DP-E 80/115-2,2/2 (Funzionamento parallelo)

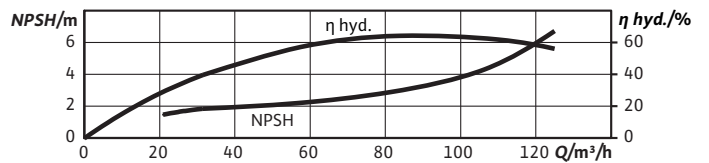
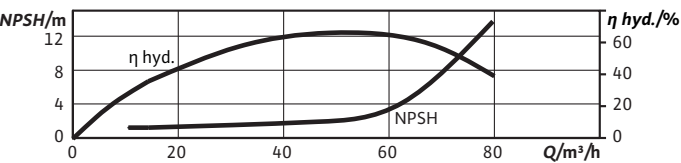
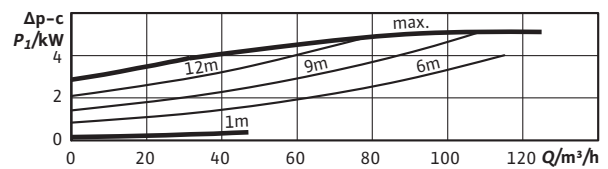
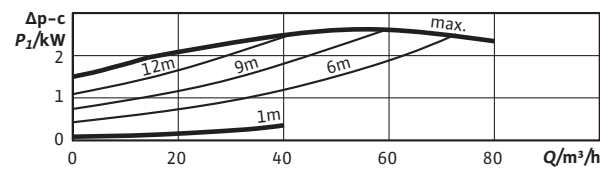
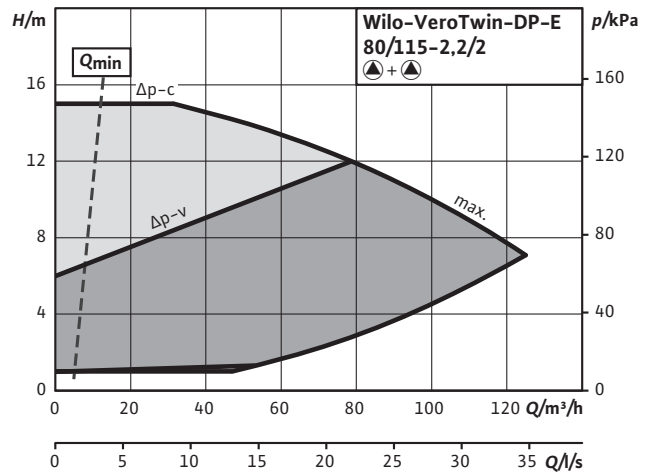
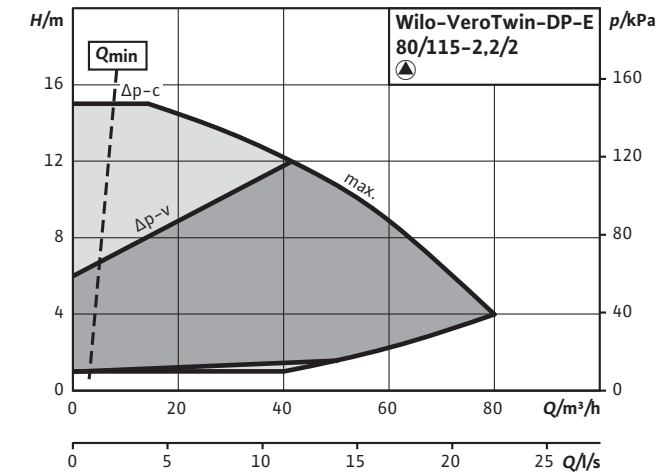
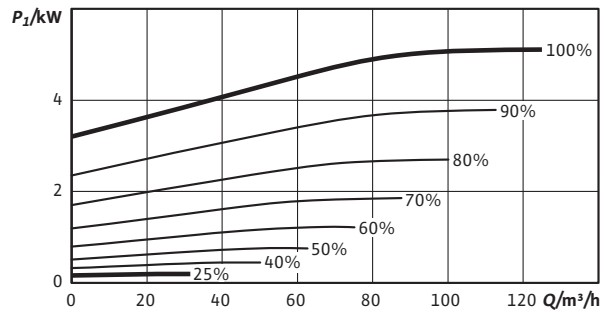
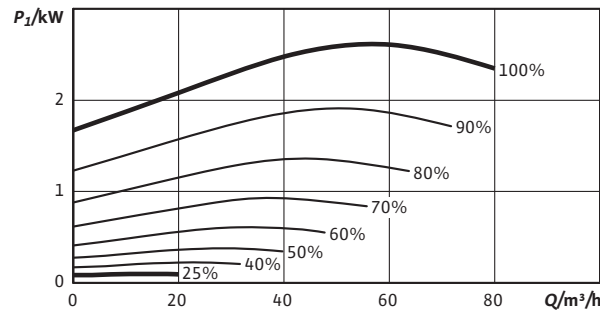
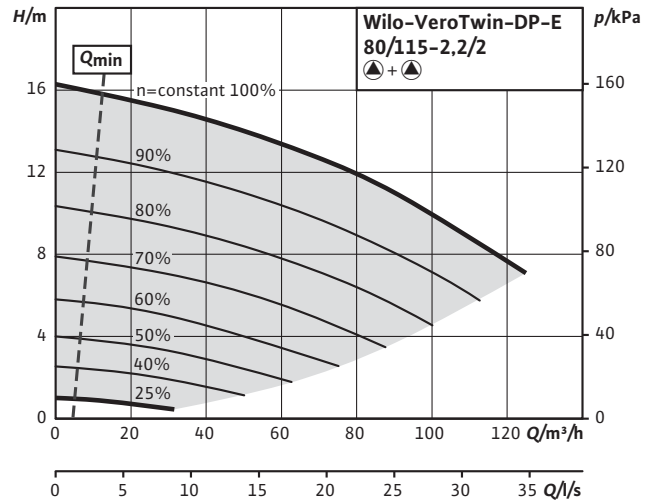
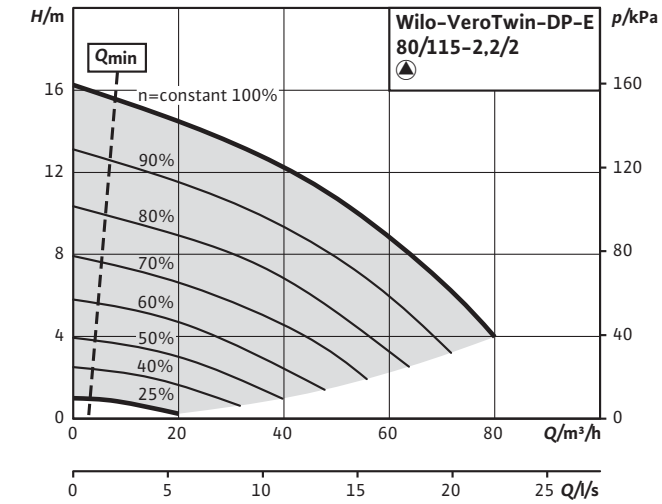

Curve caratteristiche

VeroTwin-DP-E 80/105-3/2 (Funzionamento singolo)

Curve caratteristiche

VeroTwin-DP-E 80/105-3/2 (Funzionamento parallelo)

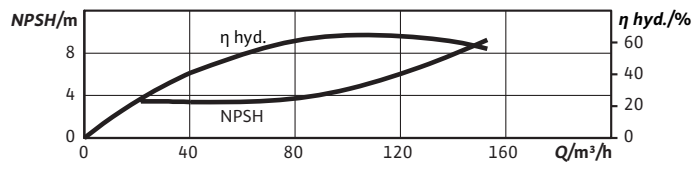
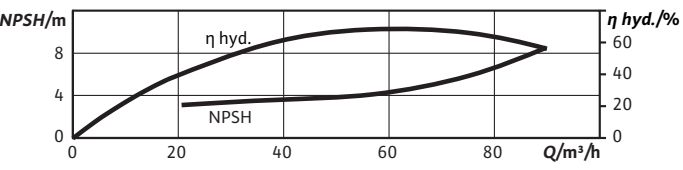
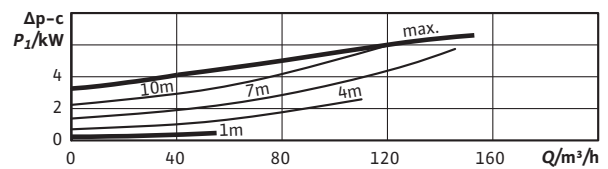
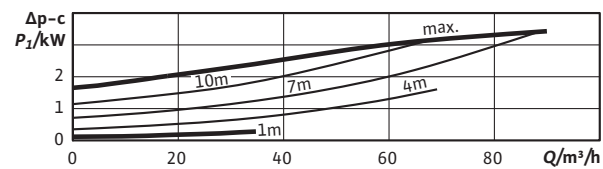
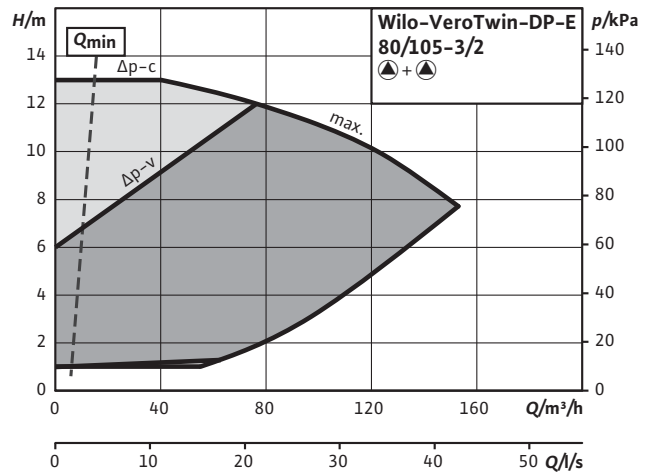
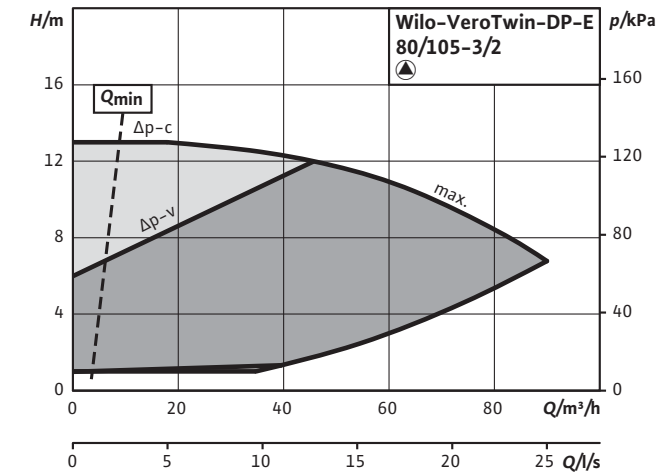
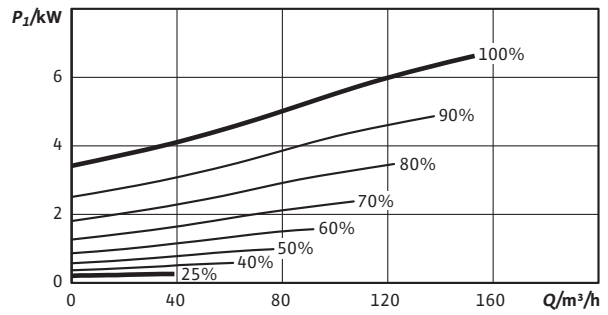
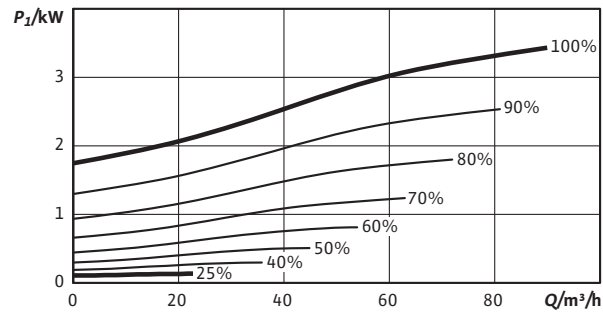
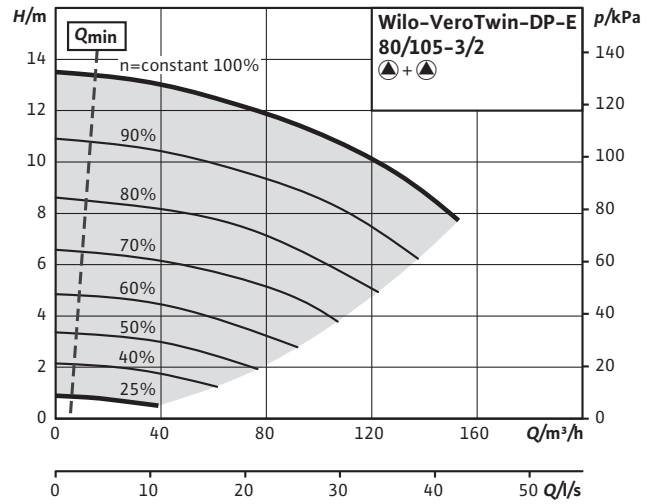
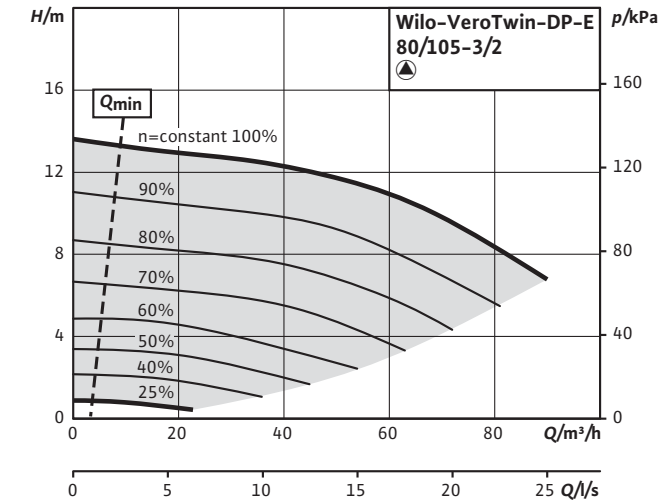

Riscaldamento, condizionamento e refrigerazione

Curve caratteristiche

Verotwin-DP-E 80/110-4/2 (Funzionamento singolo)

Curve caratteristiche

Verotwin-DP-E 80/110-4/2 (Funzionamento parallelo)

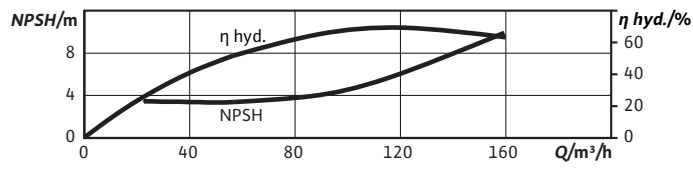
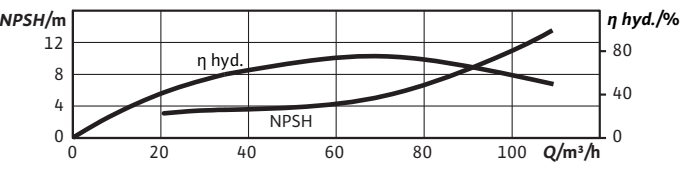
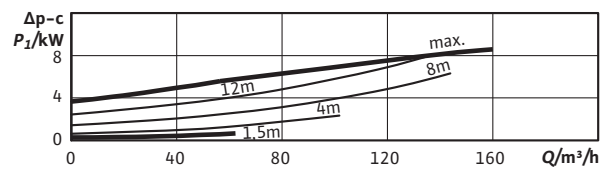
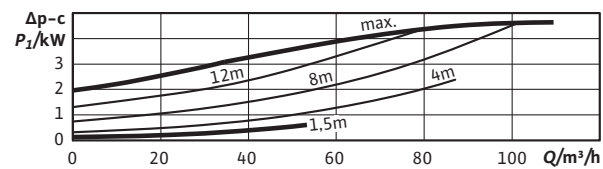
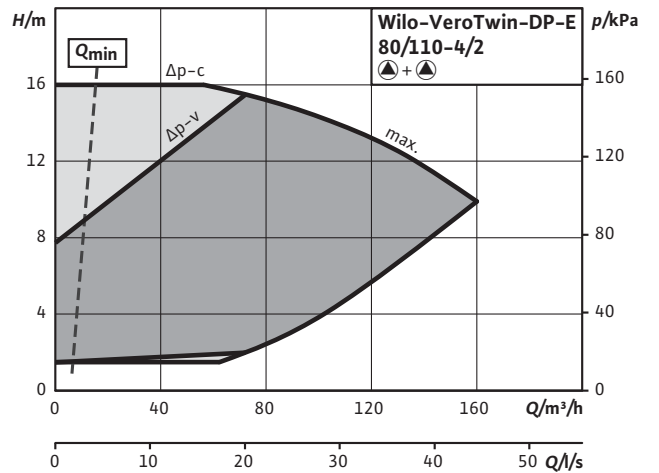
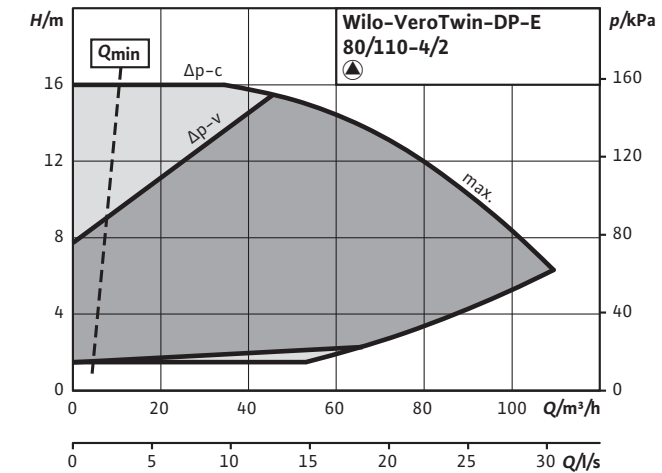
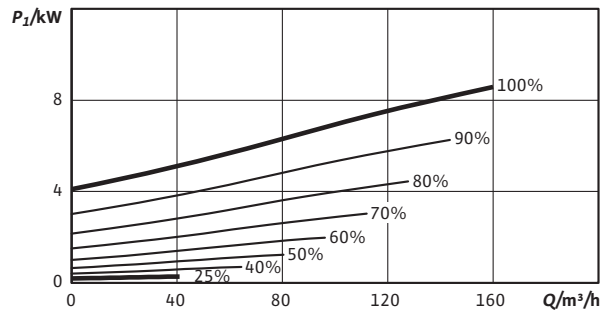
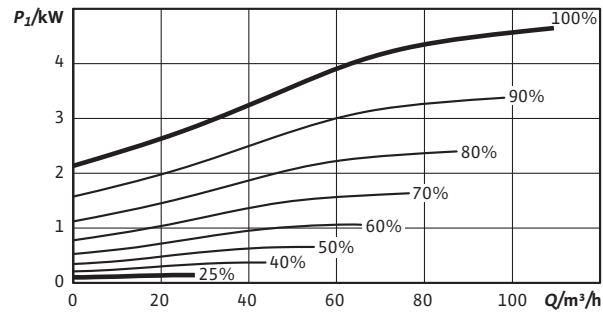
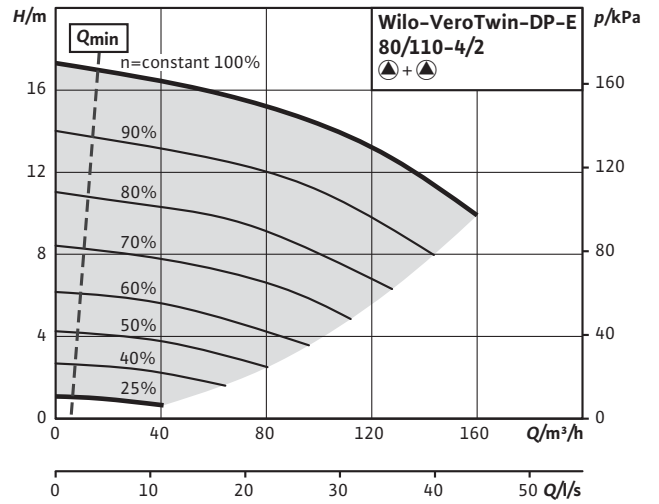
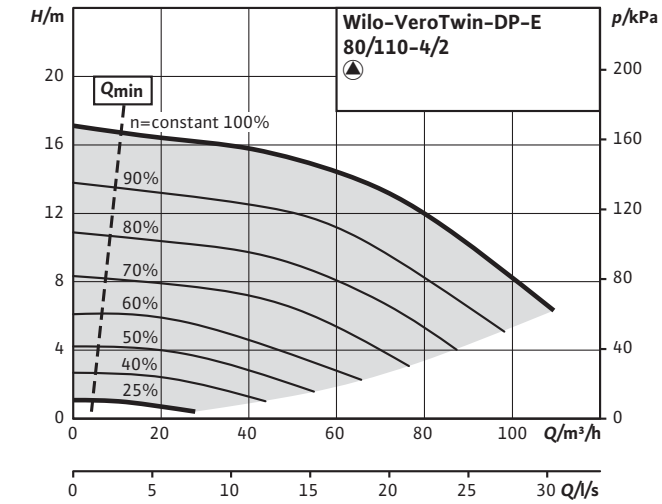



Disegno quotato

SCHEMA DIMENSIONALE A

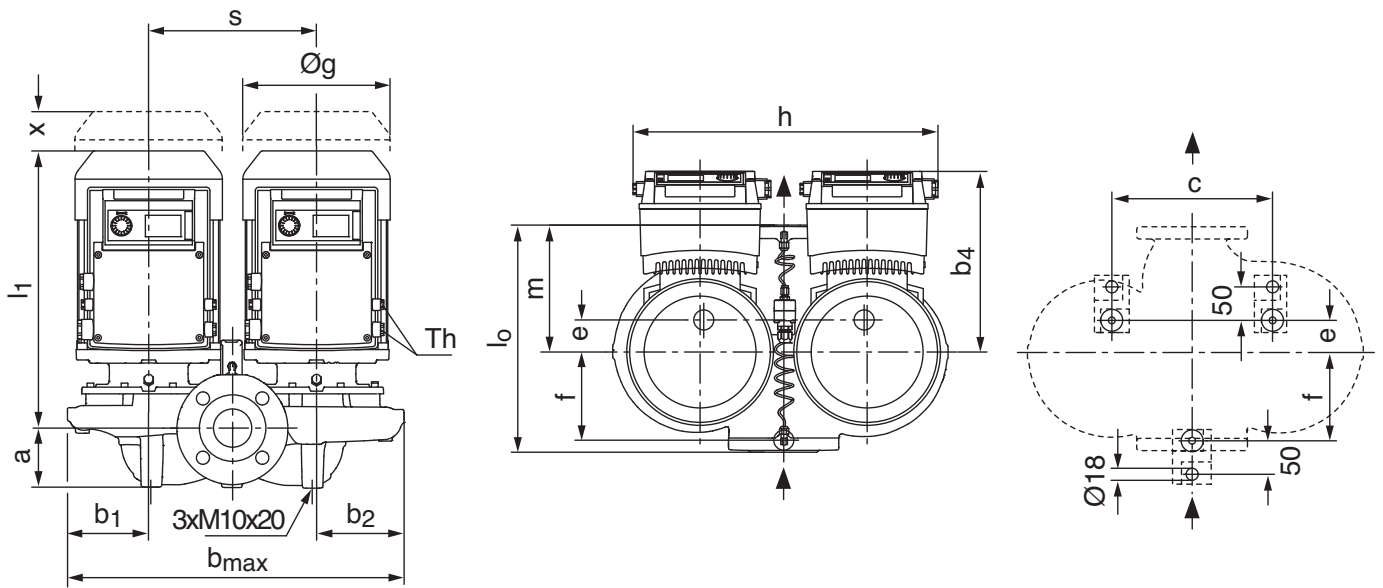

SCHEMA DIMENSIONALE B

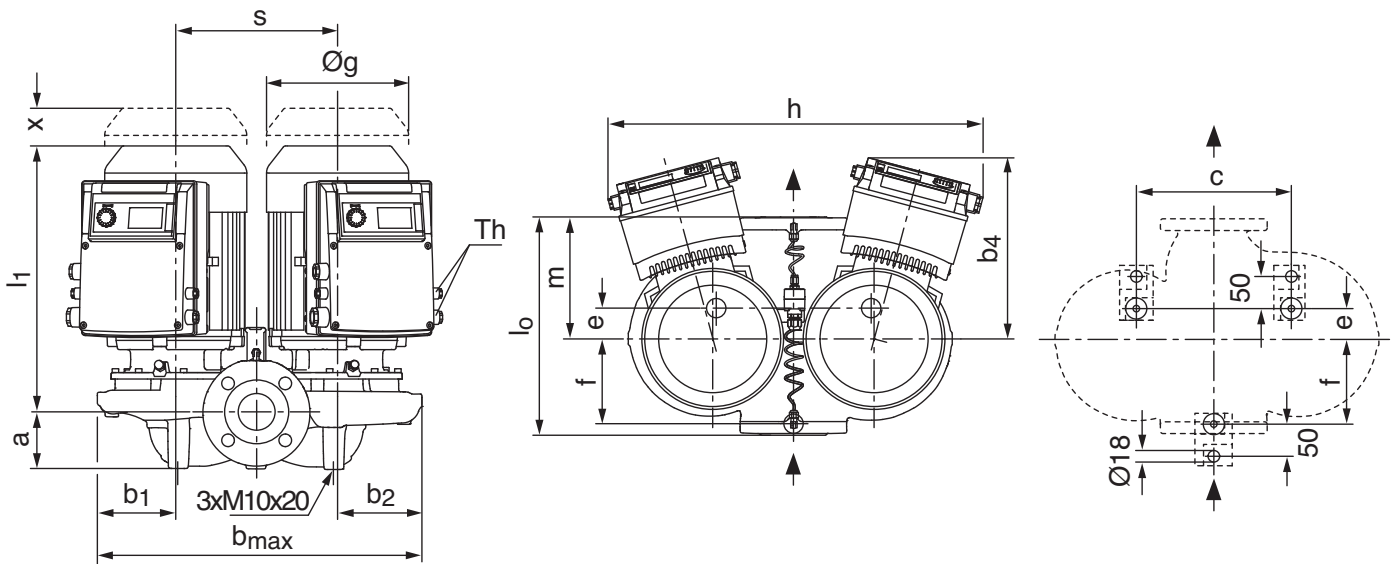

SCHEMA FLANGIE

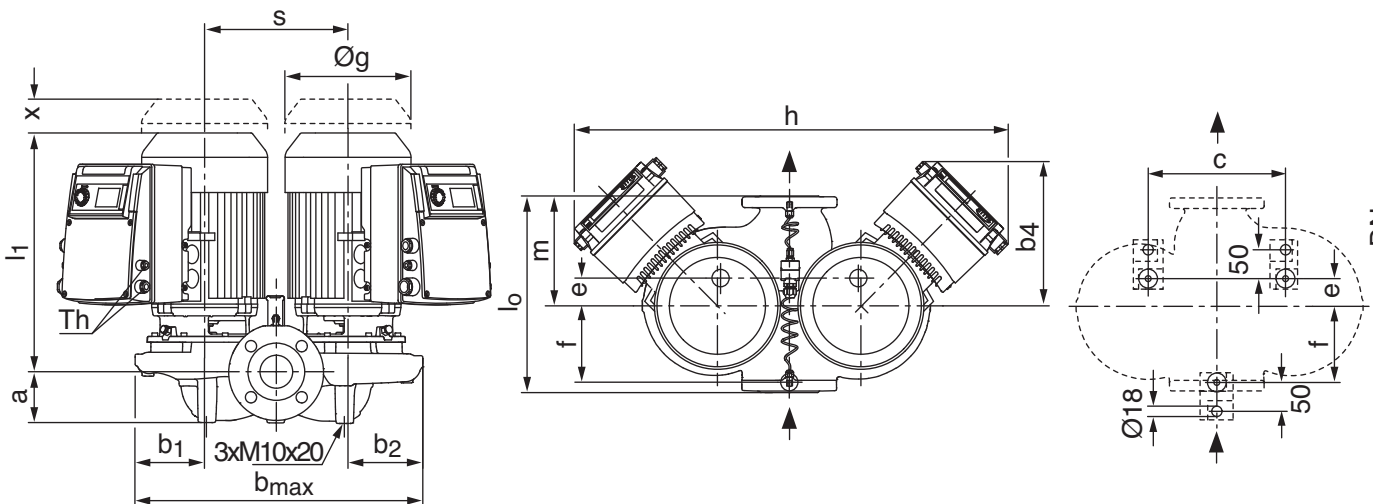



## Caratteristiche elettriche e dimensionamento

Modello	MOTORE			TRAS.	POMPA																	Schema
	POT.	INT.	DDG	DN	a	b <sub>max</sub>	b1	b2	b4	h	l0	l1	c	e	f	m	s	Øg	x	peso		
	P2	A			mm	mm	mm	mm	mm	mm	mm	mm	mm	mm	mm	mm	mm	mm	mm	mm	kg	
	kW																					
DP-E 32/95-0,55/2	0,55	1.8	20-5	32	70	395	95	95	230	637	260	321	225	50	112	130	205	130	150	45	C	
DP-E 32/105-0,75/2	0,75	3	20-5	32	70	395	95	95	235	648	260	341	225	50	112	130	205	146	150	49	C	
DP-E 32/125-1,1/2	1,1	3.4	20-5	32	70	395	95	95	235	696	260	341	225	50	112	130	205	146	150	51	C	
DP-E 32/135-1,1/2	1,1	2.8	40-4	32	70	395	95	95	235	648	260	361	225	50	112	130	205	146	150	56	C	
DP-E 32/135-1,5/2	1,5	4.6	40-4	32	70	395	95	95	258	702	260	380	225	50	112	130	205	172	150	62	C	
DP-E 40/115-0,55/2	0,55	1.6	20-3	40	75	350	90	98	247	467	250	320	225	35	97	135	174	130	150	48	B	
DP-E 40/120-1,5/2	1,5	5.2	20-3	40	75	456	113	119	258	714	320	374	240	45	135	167	224	172	150	73	C	
DP-E 40/130-2,2/2	2,2	6.8	40-3	40	75	456	113	119	258	714	320	374	240	45	135	167	224	172	150	75	C	
DP-E 40/150-3/2	3	8.8	40-3	40	75	456	113	119	267	727	320	408	240	45	135	167	224	194	150	87	C	
DP-E 40/160-4/2	4	9.7	40-3	40	75	456	113	119	275	744	320	440	240	45	135	167	224	218	150	101	C	
DP-E 50/105-0,75/2	7,5	3.1	20-3	50	83	382	90	98	254	491	280	346	228	35	122	140	194	146	150	52	B	
DP-E 50/130-2,2/2	2,2	7.7	20-3	50	86	500	120	130	258	739	340	376	240	48	132	190	250	172	150	76	C	
DP-E 50/140-3/2	3	9.1	40-3	50	86	500	120	130	271	462	340	410	240	48	132	190	250	194	150	88	A	
DP-E 50/150-4/2	4	11.5	40-3	50	86	500	120	130	283	462	340	442	240	48	132	190	250	218	150	102	A	
DP-E 65/115-1,5/2	1,5	5.1	20-1	65	93	432	103	117	278	541	340	387	225	25	137	185	212	172	150	80	B	
DP-E 65/110-2,2/2	2,2	12.0	20-4	65	93	550	125	135	259	502	340	382	240	43	137	185	290	172	150	112	A	
DP-E 65/120-3/2	3	9.6	20-3	65	93	550	125	135	271	502	340	416	240	43	137	185	290	194	150	96	A	
DP-E 65/130-4/2	4	11.2	40-3	65	93	550	125	135	283	502	340	448	240	43	137	185	290	218	150	110	A	
DP-E 80/115-2,2/2	2,2	6.8	20-3	80	100	480	113	132	278	564	360	389	240	43	137	205	235	172	150	88	B	
DP-E 80/105-3/2	3	9.5	20-3	80	103	601	134	147	250	532	360	422	240	30	150	192	320	194	150	96	A	
DP-E 80/110-4/2	4	11.4	20-4	80	103	601	134	147	262	532	360	454	240	30	150	192	320	218	150	110	A	

## ✓ Schema Flangie

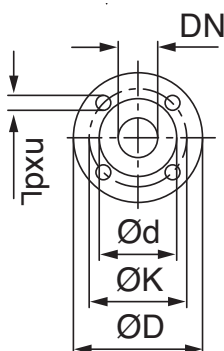

DN2	ØD	Øk	Ød	fori
	mm	mm	mm	n x Ø
32	140	76	100	4 x 19
40	150	84	110	4 x 19
50	165	99	125	4 x 19
65	185	118	145	4 x 19
80	200	132	160	8 x 19

# Wilo-CronoLine IL-E

Pompa singola a motore ventilato regolata elettronicamente

Per impianti di riscaldamento, condizionamento e refrigerazione commerciali ed industriali.



## Esecuzione

Pompe singole complete di trasduttore di pressione differenziale



## Efficienza

Motore elettrico normalizzato in classe di efficienza IE4 con accoppiamento con giunto rigido in esecuzione 2 e 4 poli



## Idraulica

Pompa con lanterna e giunto rigido per accoppiamento con motore normalizzato, tenuta meccanica standard.



Per maggiori informazioni sui prodotti:  
[www.wilo.it](http://www.wilo.it)



### Focus

- Efficienza idraulica  $MEI > 0,4$   
(secondo Direttiva ErP Regolamento CE n.547/2012)
- Efficienza motore IE4 (secondo IEC TS 60034-31 Ed.1)

### Vantaggi

- Campo di regolazione fino a tre volte maggiore delle pompe tradizionali regolate elettronicamente
- Con le interfacce seriali WILO-IF si integra con qualsiasi sistema di automazione degli edifici (BMS)

### In evidenza

Il display LCD di grandi dimensioni permette di visualizzare rapidamente i dati di SET della pompa.



### Tecnologia

La tecnologia 'pulsante rosso' rende la regolazione e l'installazione della pompa semplice e rapida.



### Installazione

I moduli WILO-IF permettono la connessione a tutte le reti di Building Management System.





Range upgrade



## Wilo-CronoLine-IL-E, efficace



### Chiave di lettura

Esempio	<b>IL-E 50/170-7,5/2-R1</b>
<b>IL-E</b>	Pompa inline con regolazione elettronica
<b>50</b>	Diametro nominale DN della bocca
<b>170</b>	Diametro nominale della girante
<b>7,5</b>	Potenza nominale del motore P <sub>2</sub> in kW
<b>2</b>	Numero poli
<b>R1</b>	Versione senza sensore di pressione

### Particolarità/vantaggi del prodotto

- Motore elettrico IE4
- Risparmio energetico grazie alla regolazione della velocità integrata
- WILO-Moduli-IF opzionale per l'integrazione in sistemi di building automation
- Tecnologia del pulsante rosso e display per un semplice utilizzo
- Management integrato (2 pompe singole)
- Protezione integrale del motore

Dati tecnici	
Indice di efficienza minimo (MEI)	≥ 0,4
<b>Fluidi consentiti (altri fluidi su richiesta)</b>	
Acqua riscaldamento (secondo VDI 2035)	Si
Miscela acqua/glicole (con 20-40 % vol. di glicole e temperatura fluido ≤ 40 °C)	Si
Acqua fredda e refrigerata	Si
Olio diatermico	Versione speciale
<b>Campo d'applicazione consentito</b>	
Campo di temperatura con una temperatura ambiente max. di +40 °C	-20...+140 °C (a seconda del fluido di pompaggio)
Pressione nominale PN	13 bar (fino a +140 °C) 16 bar (fino a +120 °C)
<b>Alimentazione elettrica</b>	
Alimentazione rete	3~440V ±10%, 50/60 Hz 3~400V ±10%, 50/60 Hz 3~380V -5%/+10%, 50/60 Hz

Dati tecnici	
<b>Motore/elettronica</b>	
Indice di efficienza motore elettrico	IE4
Protezione integrale del motore	Si
Grado protezione	IP 55
Classe isolamento	F
Emissione disturbi	EN 61800-3
Immunità	EN 61800-3
<b>Materiali</b>	
Corpo pompa	EN-GJL-250
Lanterna	EN-GJL-250
Girante	EN-GJL-200
Girante (versione speciale)	G-CuSn10
Albero della pompa	1.4122
Tenuta meccanica	AQEGG
Altre tenute meccaniche	su richiesta

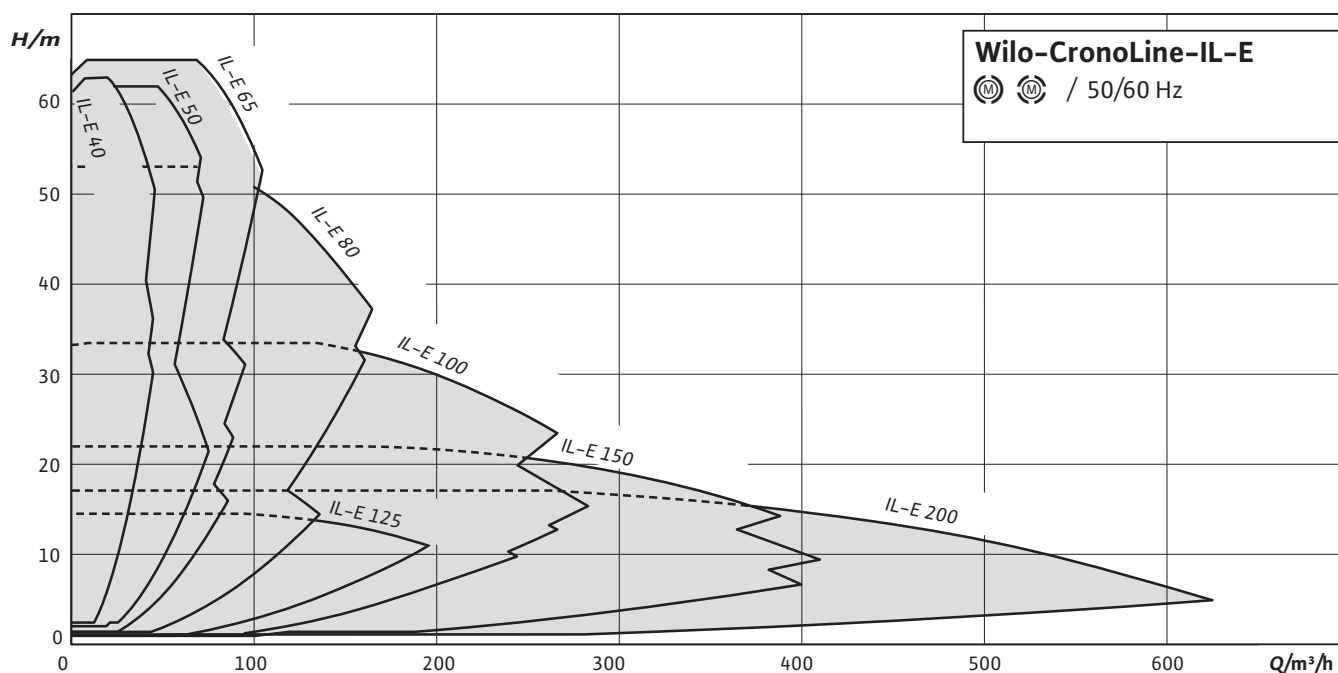

### Equipaggiamento/funzionamento

#### Modi di funzionamento

- $\Delta p$ -c per pressione differenziale costante
- $\Delta p$ -v per pressione differenziale variabile
- Controllo PID
- Funzionamento come servomotore (n = costante)

#### Livello di comando

- Pulsante rosso e display

#### Funzioni manuali

- Impostazione pompa on/off
- Impostazione del modo funzionamento
- Configurazione di tutti i parametri di esercizio
- Impostazione del numero di giri
- 

#### Funzioni di comando esterne

- Ingresso di comando "prioritario Off"
- Ingresso di comando "scambio pompa" (solo con funzionamento a pompa doppia)
- Ingresso analogico per funzionamento come servomotore (DDC) e regolazione a distanza del valore di consegna:
  - 0-10 V
  - 2-10 V
  - 0-20 mA
  - 4-20 mA
- Ingresso analogico per segnale diretto dal sensore di pressione:
  - 0-10 V
  - 2-10 V
  - 0-20 mA
  - 4-20 mA

#### Funzioni di segnalazione e visualizzazione

- Segnalazione cumulativa di blocco SSM
- Segnalazione cumulativa di funzionamento SBM

#### Scambio dati

- Porta di comunicazione a infrarossi per lo scambio dati senza fili con monitor IR o WILO-IR STICK
- Vano per innesto di moduli IF Wilo (Modbus, BACnet, CAN, PLR, LON) per interfaccia al sistema di automazione degli edifici (BMS)

→

#### Funzioni di sicurezza

- Protezione integrale del motore con elettronica di sgancio integrata
- Blocco accesso (regolazione)

#### Management pompa doppia (2 pompe singole)

- Funzionamento principale/di riserva scambio pompa dopo 24 ore di funzionamento (o eventuale anomalia ad una pompa)
- Funzione pompa doppia (somma di portata) punto di funzionamento ottimizzato al migliore rendimento

#### Opzioni

- Versione ...-R1 senza trasduttore di pressione differenziale
- Variante ...-S1/-S2 con tenuta meccanica speciale

#### Accessori

- 3 mensole con materiale di fissaggio per montaggio a basamento
- Monitor IR, WILO-IR STICK
- Modulo IF PLR per collegamento a PLR/convertitore porta di comunicazione
- Modulo IF LON per collegamento alla rete LONWORKS
- Modulo IF BACnet
- Modulo IF Modbus
- Modulo IF CAN
- Quadri elettrici di controllo VR-HVAC
- Quadri elettrici di controllo CcE-HVAC
- Quadri elettrici di controllo SCe-HVAC
- Trasduttore differenza di pressione (DDG)

Curve caratteristiche

CronoLine-IL-E 100/220-5,5/4 (4 poli)

Curve caratteristiche

CronoLine-IL-E 100/250-7,5/4 (4 poli)

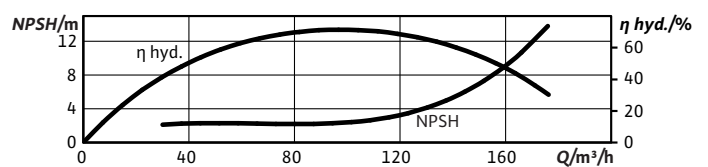
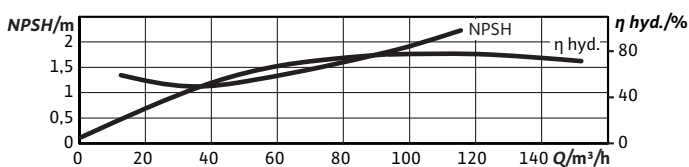
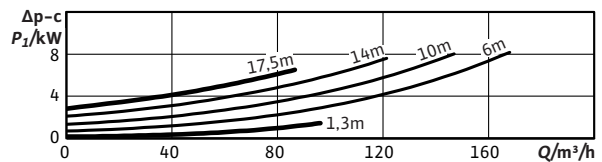
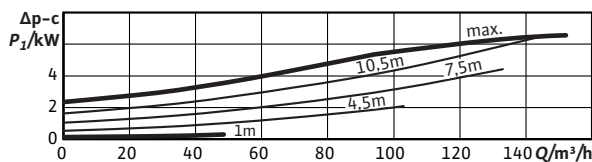
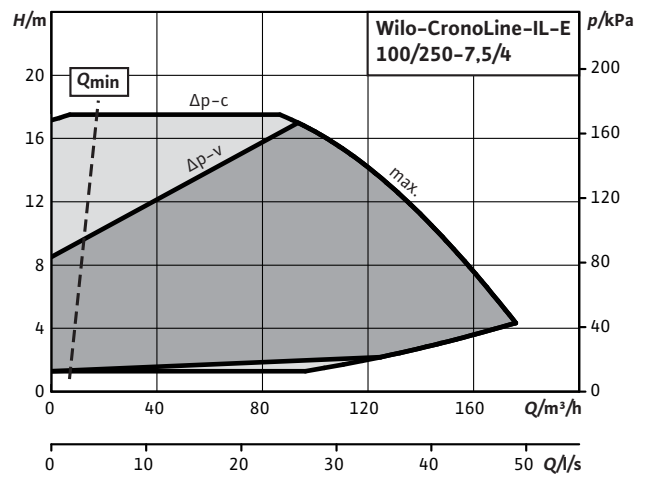
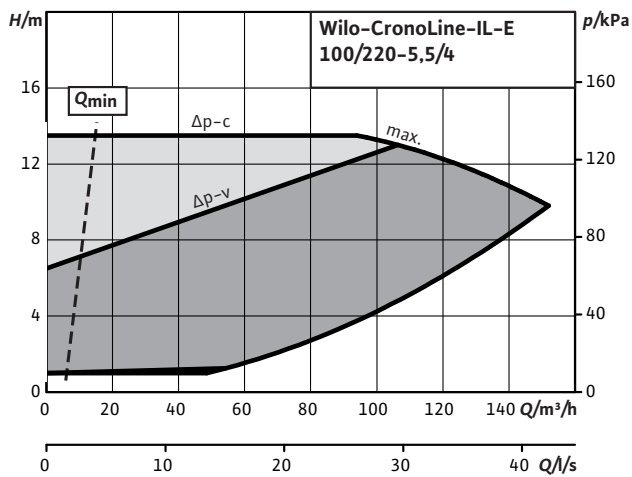
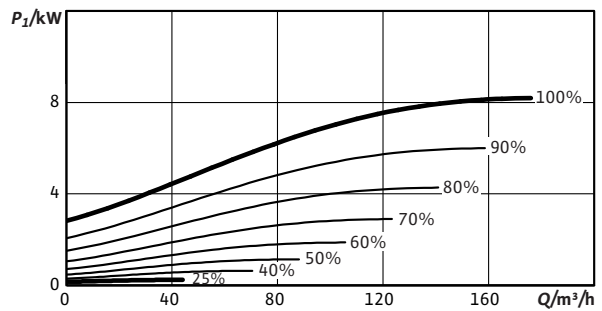
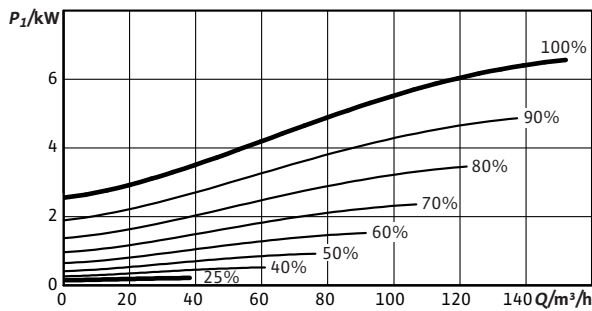
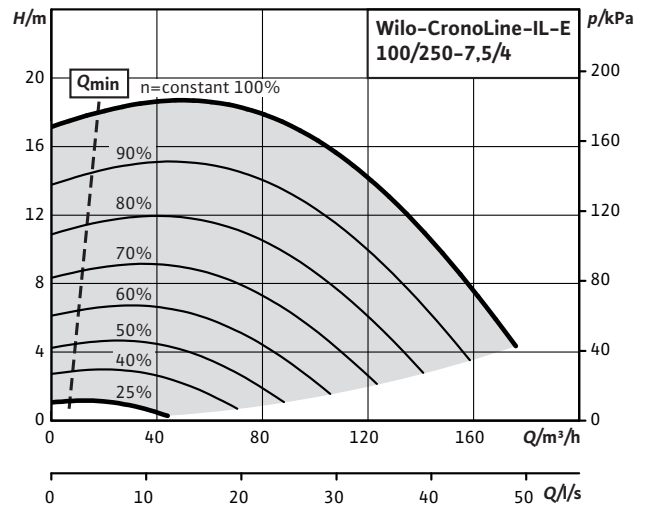
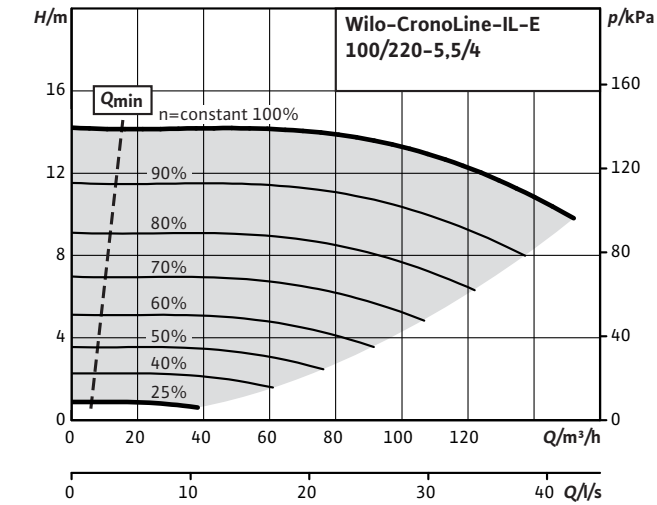

Curve caratteristiche

CronoLine-IL-E 100/270-11/4 (4 poli)

Curve caratteristiche

CronoLine-IL-E 125/210-5,5/4 (4 poli)

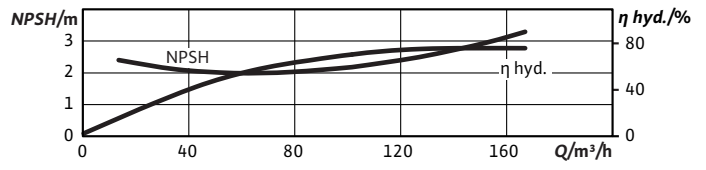
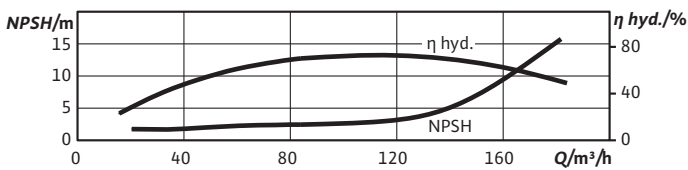
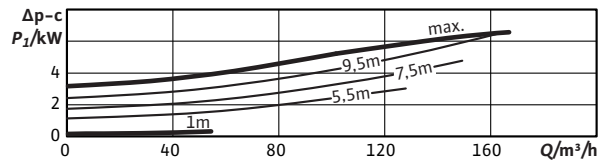
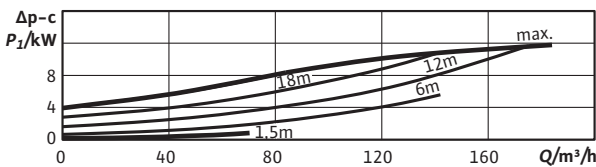
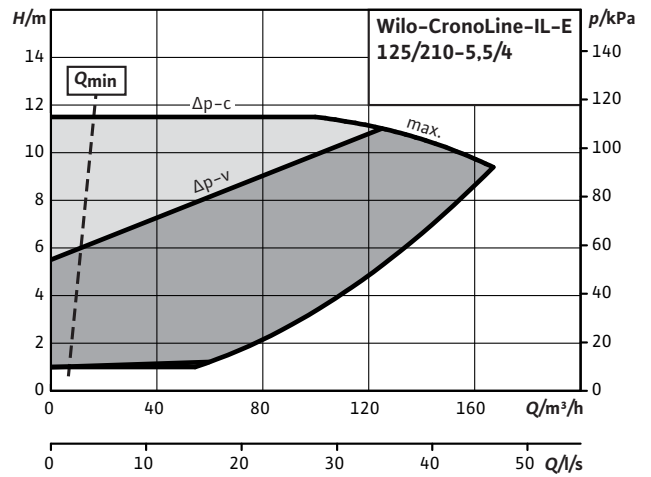
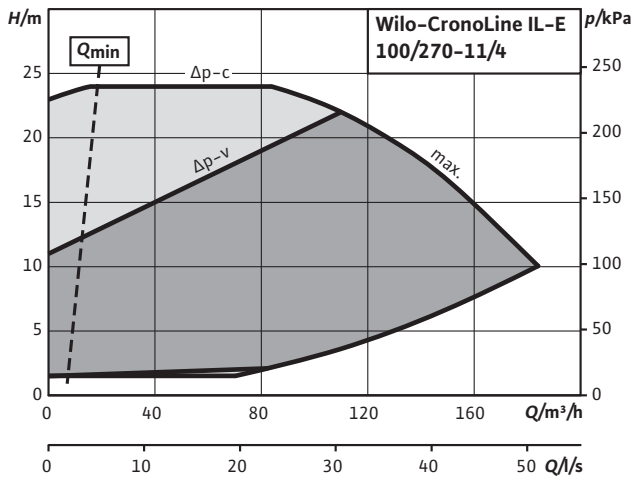
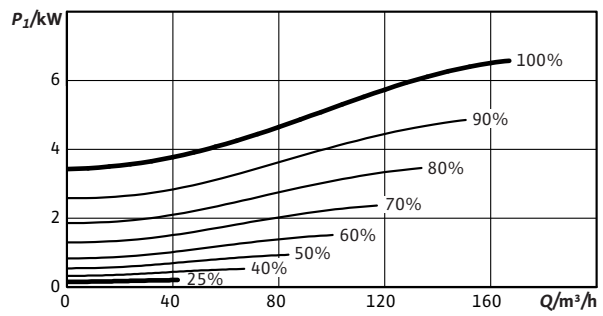
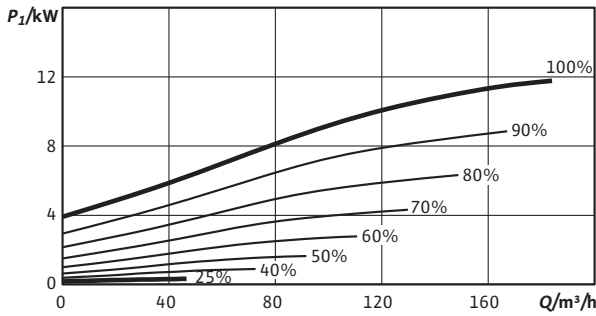
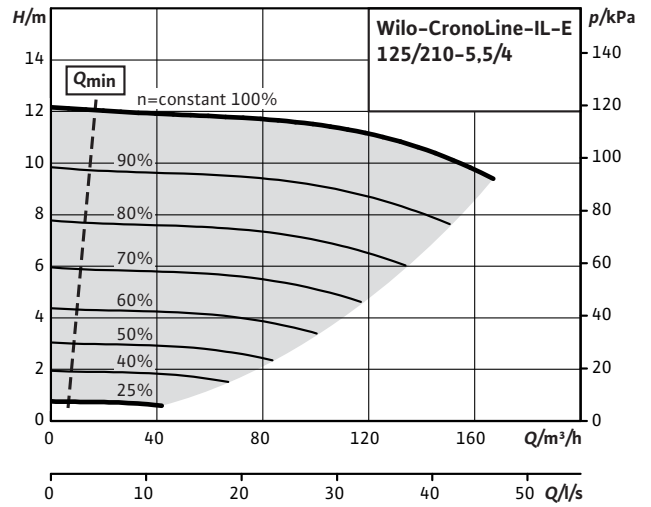
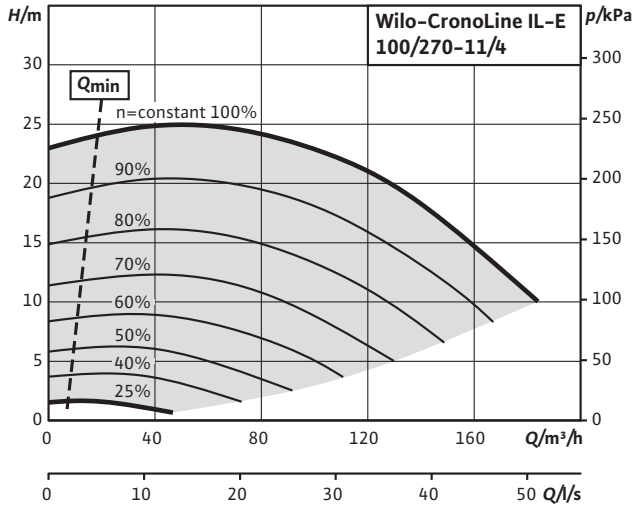

Riscaldamento, condizionamento e refrigerazione

Curve caratteristiche

CronoLine-IL-E 125/220-7,5/4 (4 poli)

Curve caratteristiche

CronoLine-IL-E 150/190-5,5/4 (4 poli)

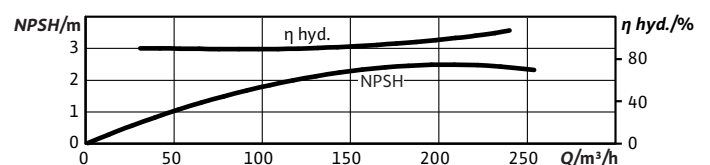
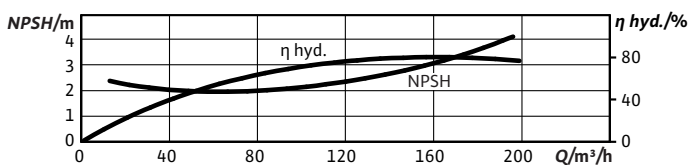
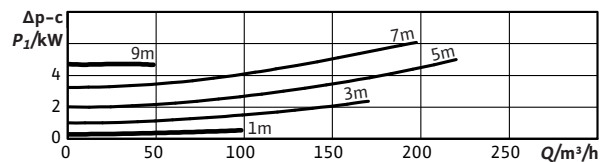
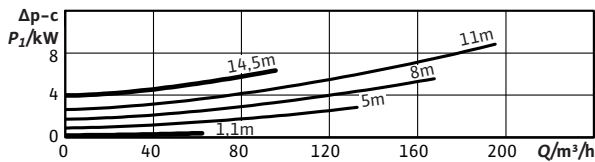
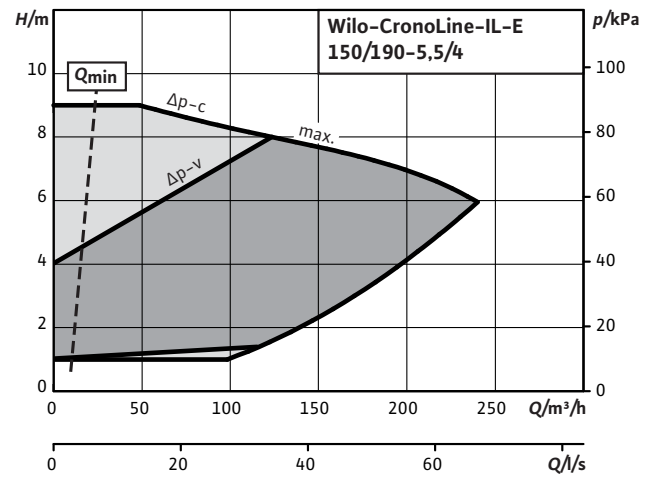
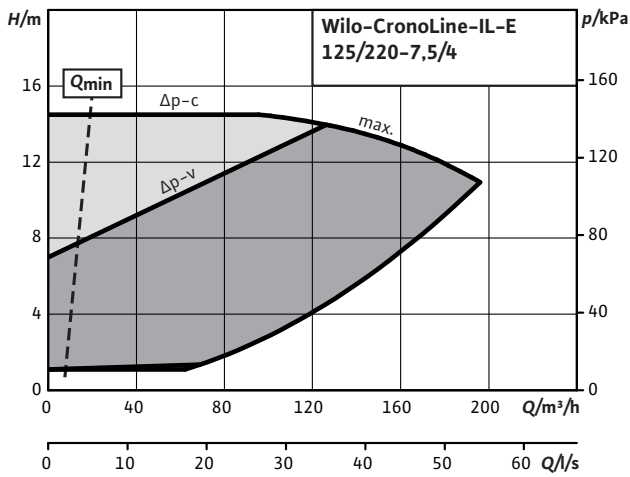
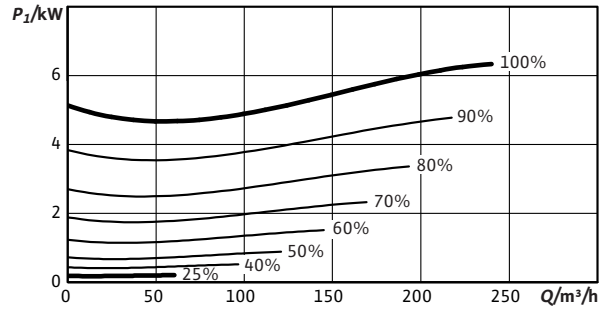
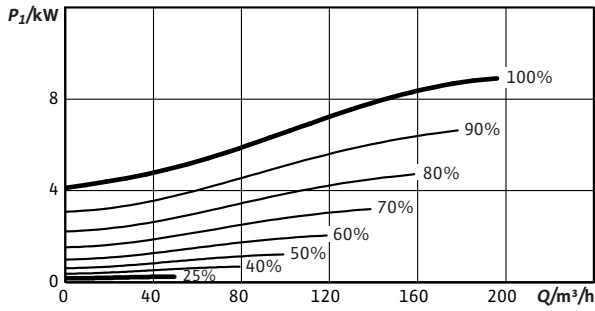
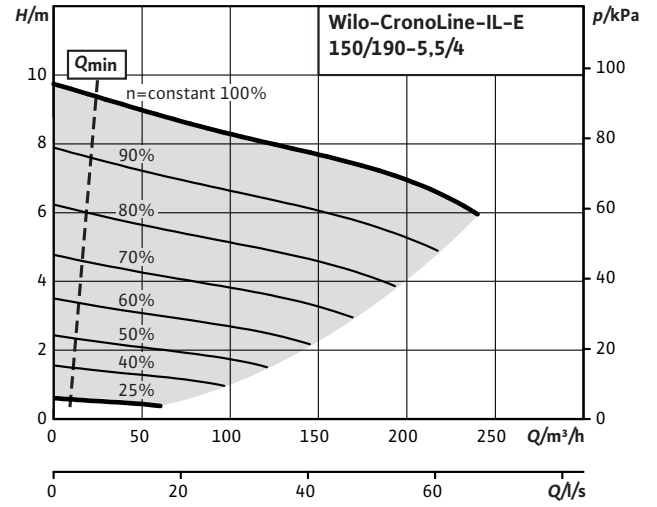
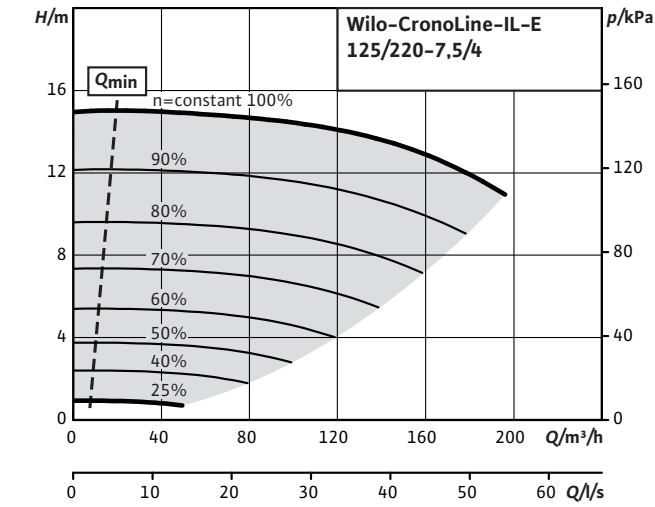



Curve caratteristiche

CronoLine-IL-E 150/200-7,5/4 (4 poli)

Curve caratteristiche

CronoLine-IL-E 150/220-11/4 (4 poli)

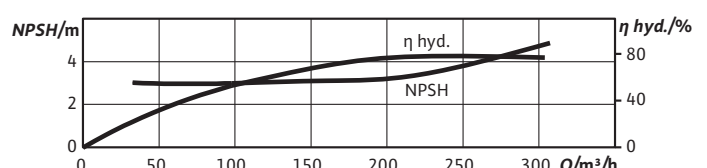
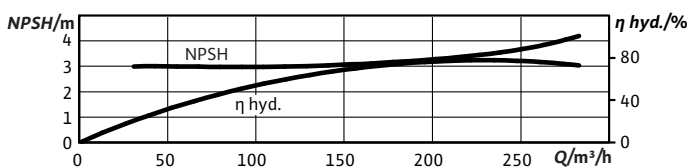
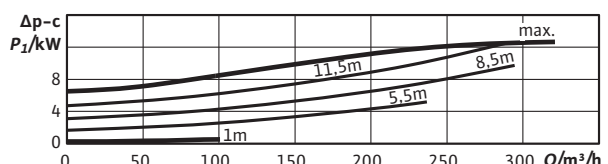
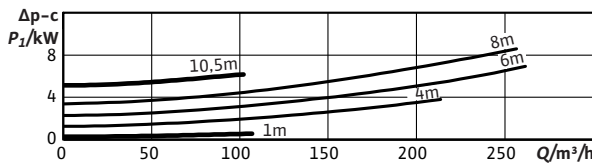
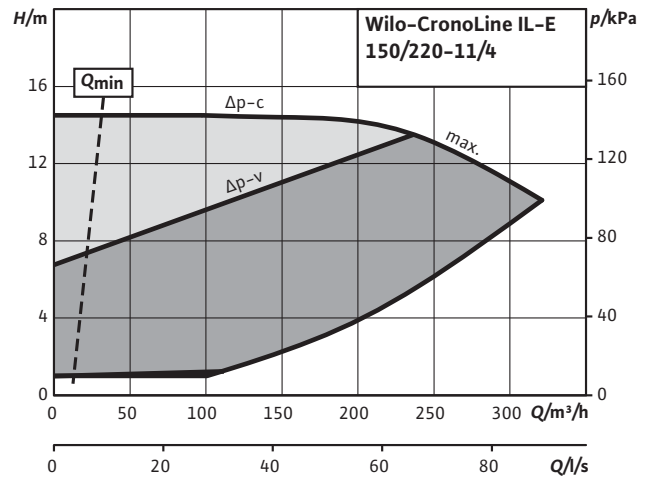
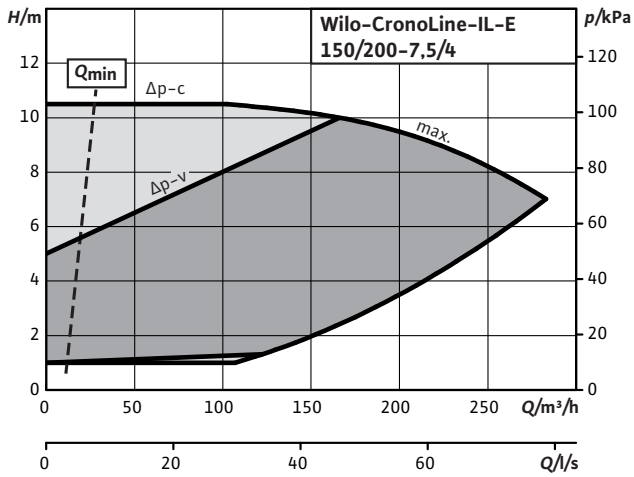
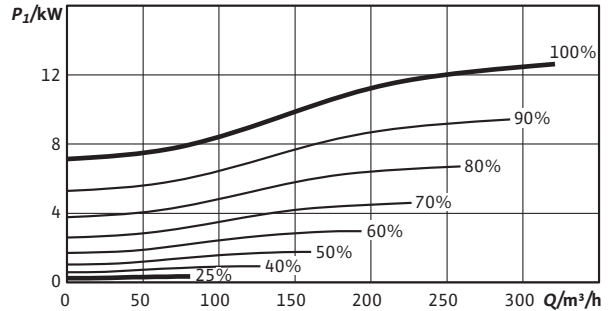
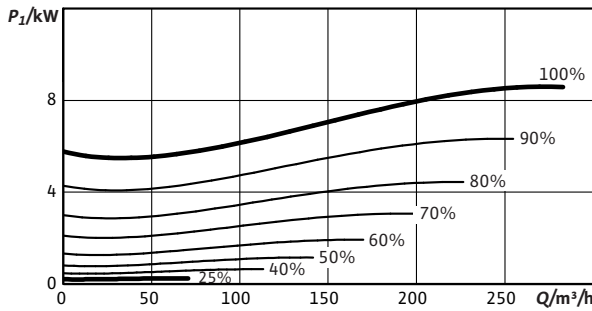
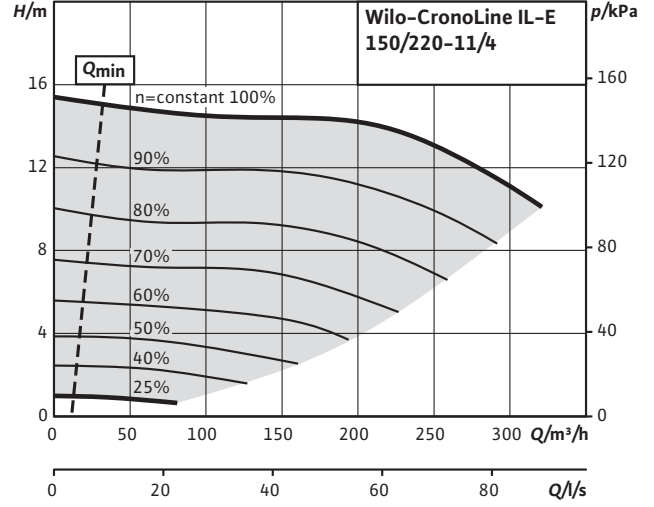
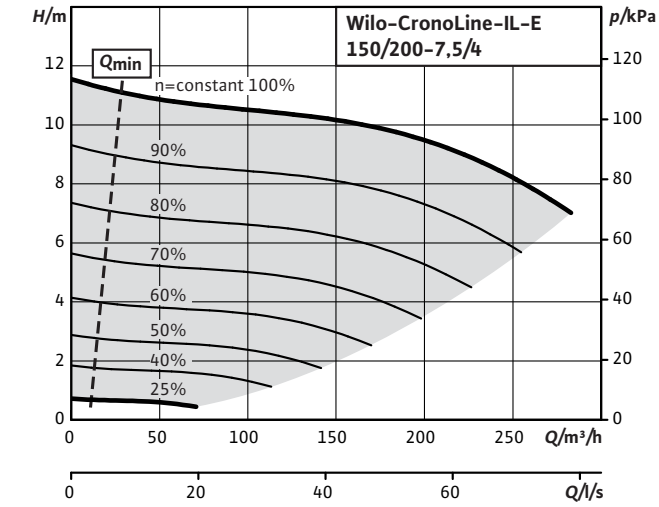

Riscaldamento, condizionamento e refrigerazione

Curve caratteristiche

CronoLine-IL-E 150/250-15/4 (4 poli)

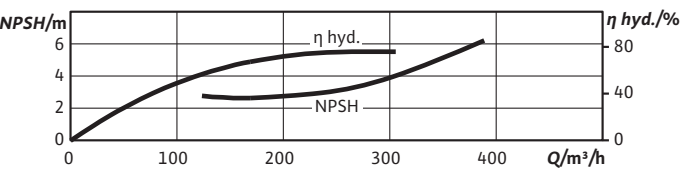
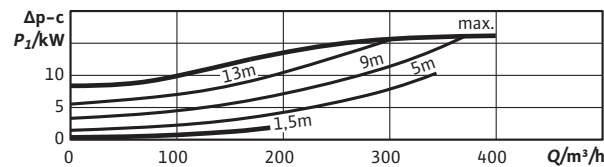
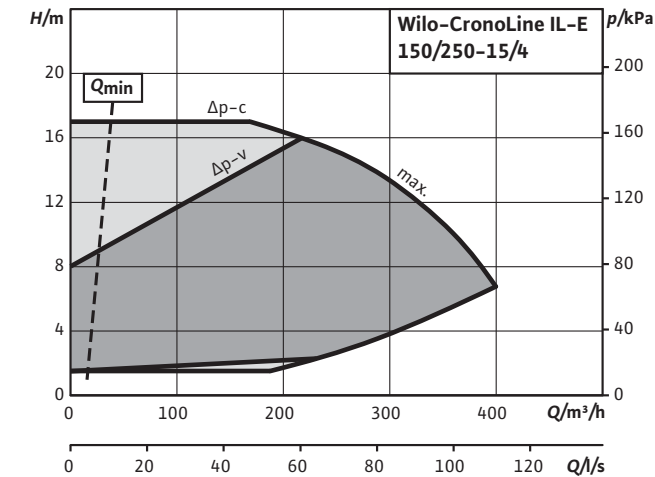
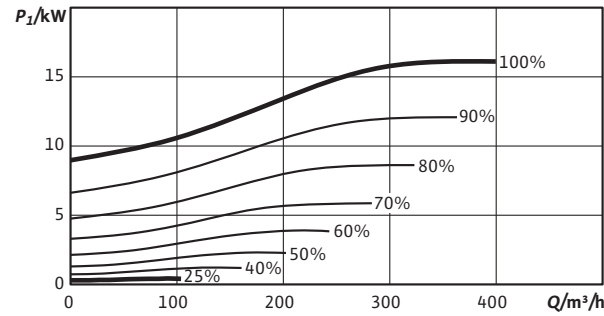
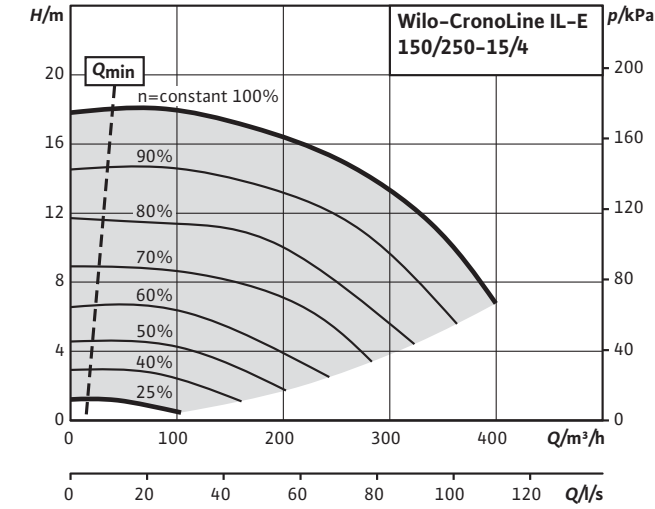

Curve caratteristiche

CronoLine-IL-E 150/260-18,5/4 (4 poli)

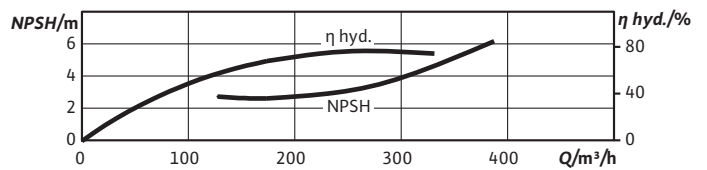
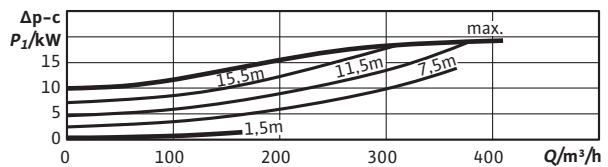
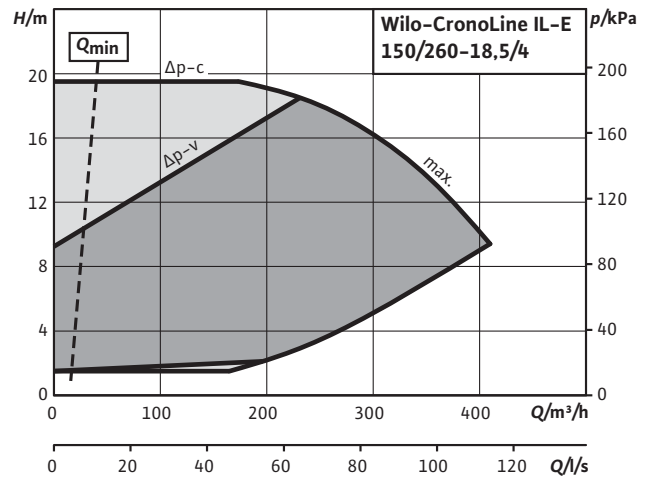
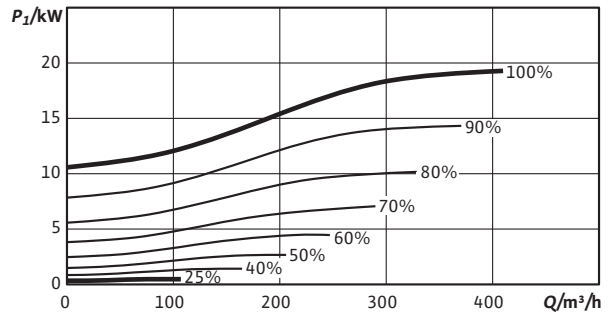
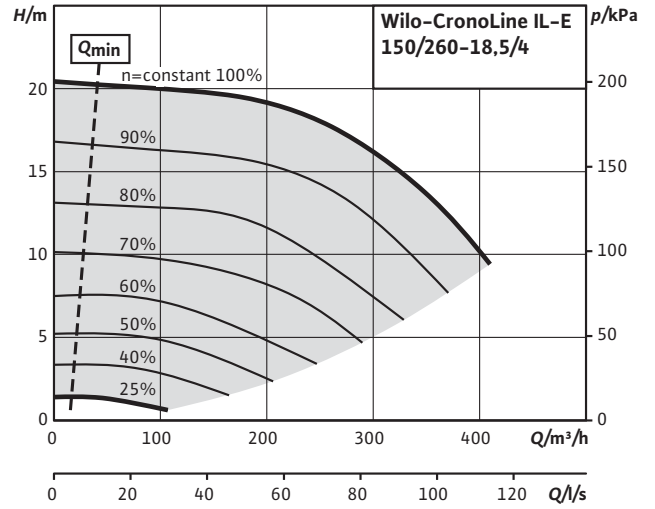

Curve caratteristiche

CronoLine-IL-E 150/270-22/4 (4 poli)

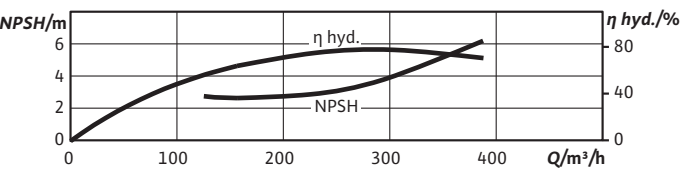
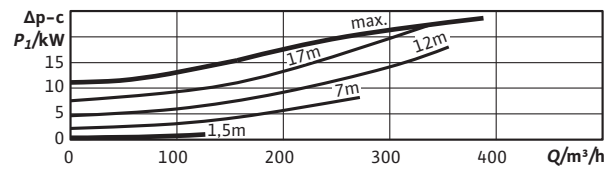
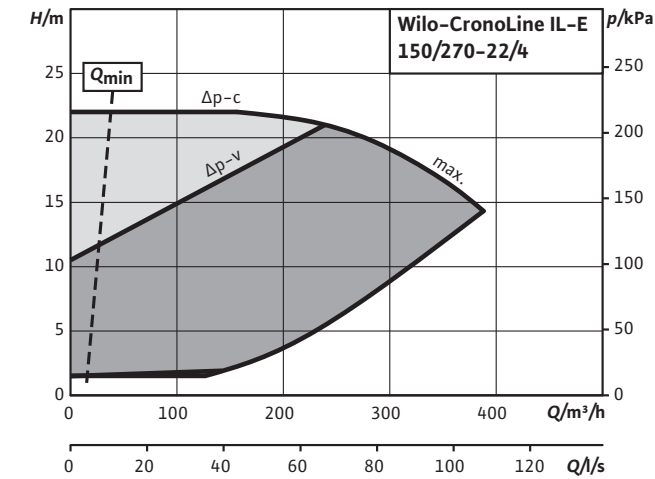
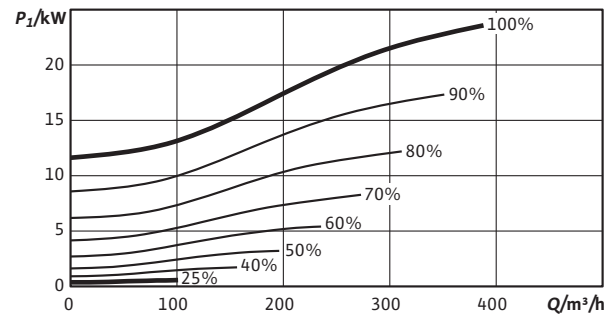
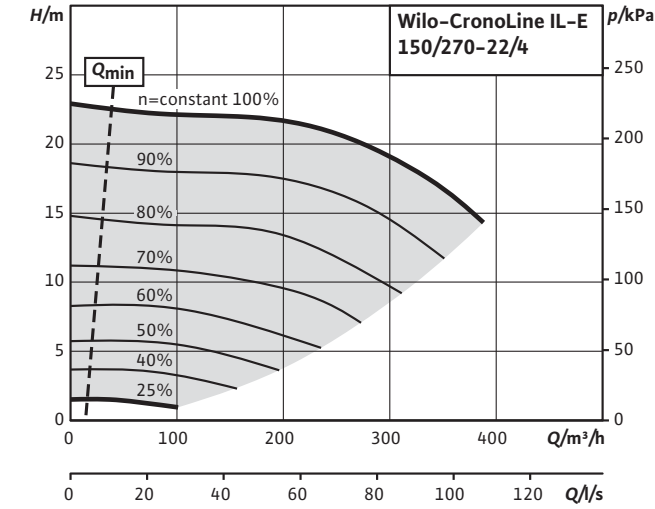

Curve caratteristiche

CronoLine-IL-E 200/240-15/4 (4 poli)

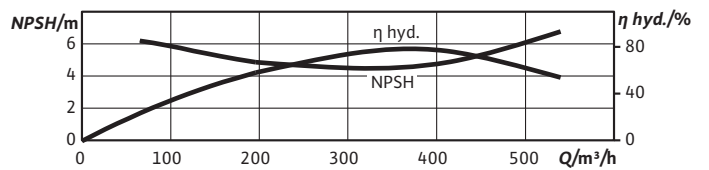
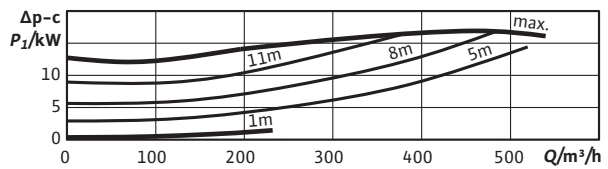
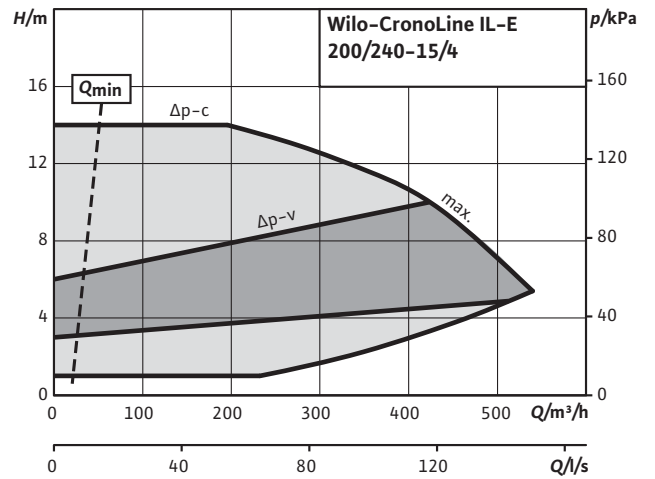
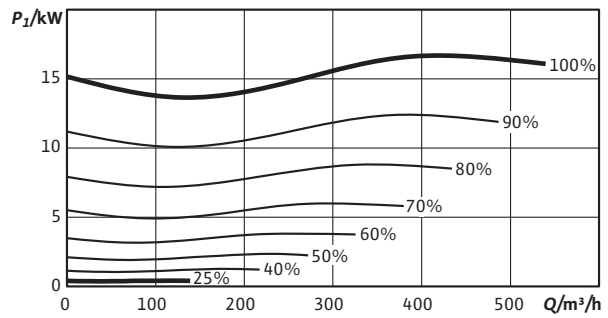
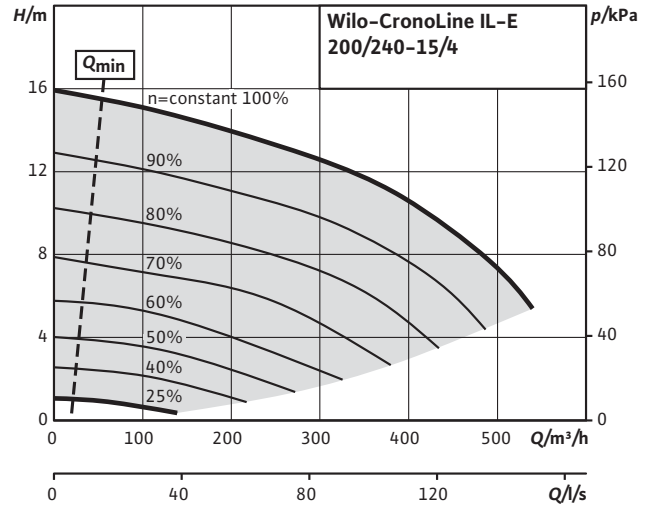

Riscaldamento, condizionamento e refrigerazione

Curve caratteristiche

CronoLine-IL-E 200/250-18,5/4 (a 4 poli)

Curve caratteristiche

CronoLine-IL-E 200/260-22/4 (4 poli)

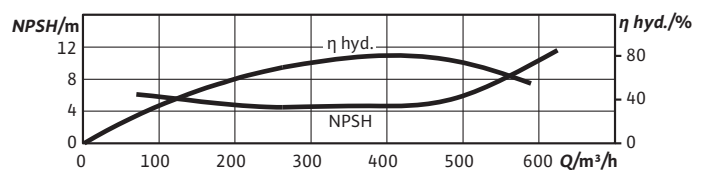
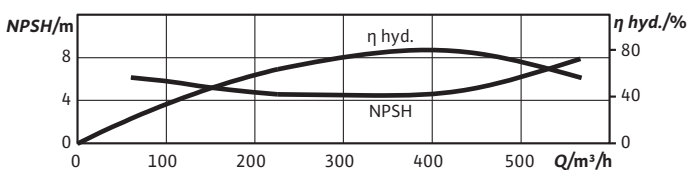
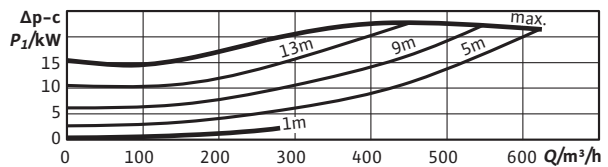
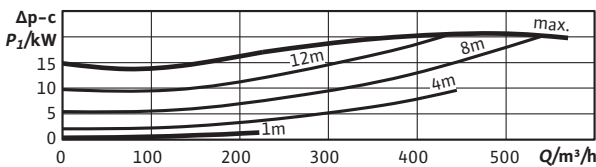
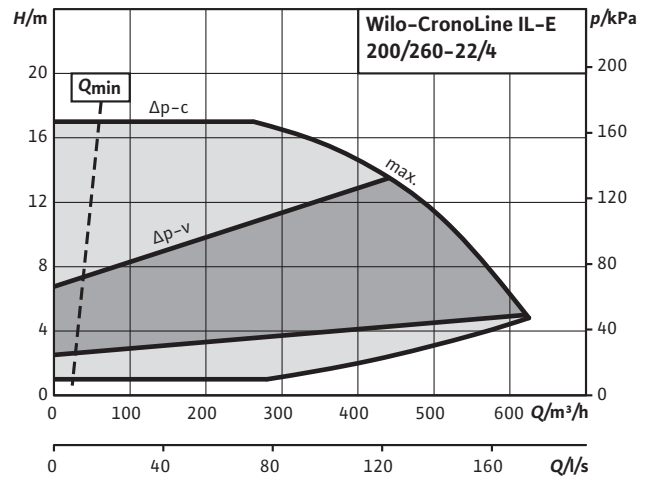
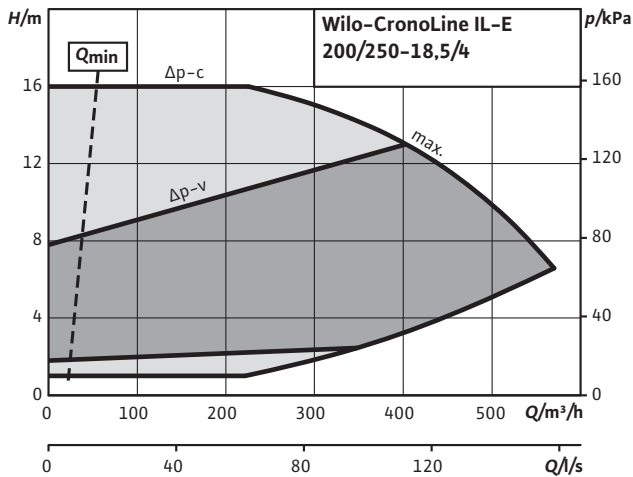
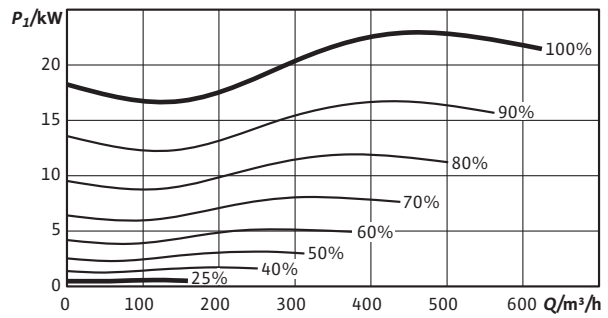
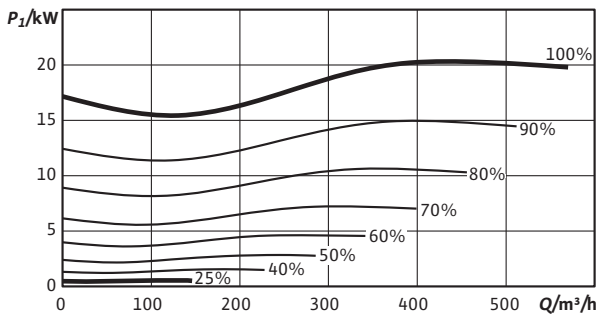
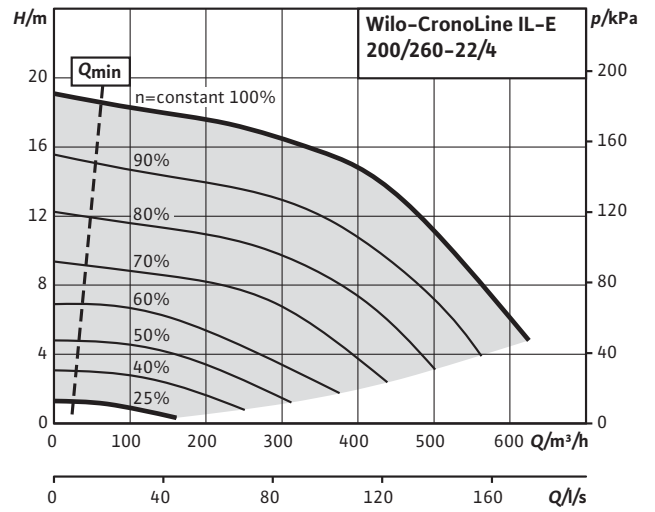
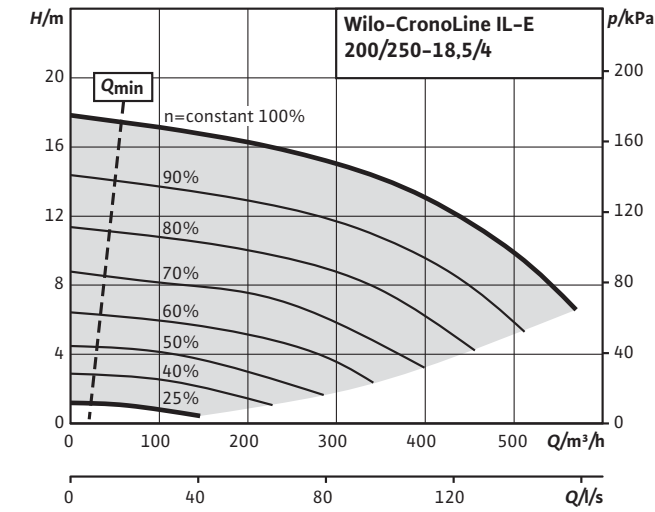

Curve caratteristiche

CronoLine-IL-E 40/170-5,5/2 (2 poli)

Curve caratteristiche

CronoLine-IL-E 40/200-7,5/2 (2 poli)

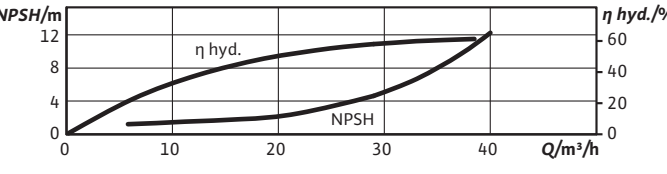
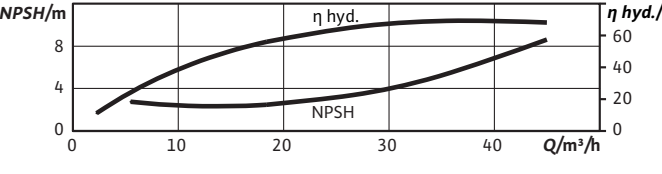
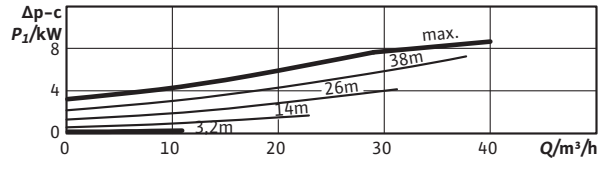
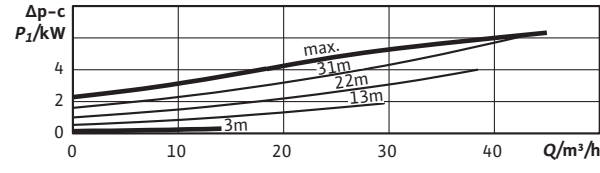
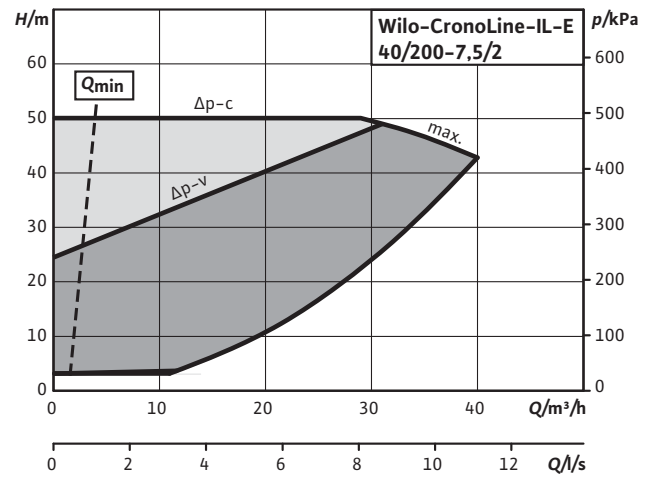
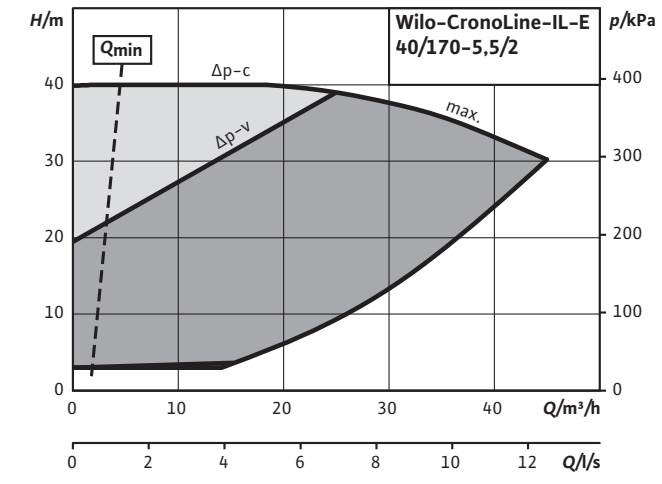
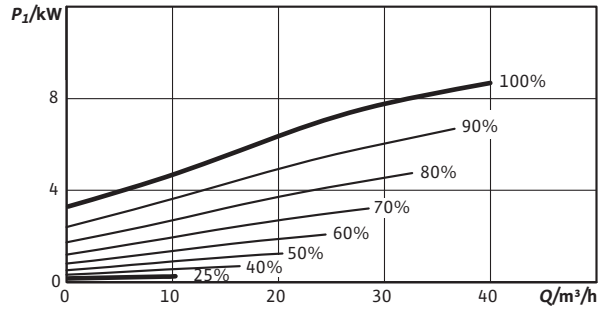
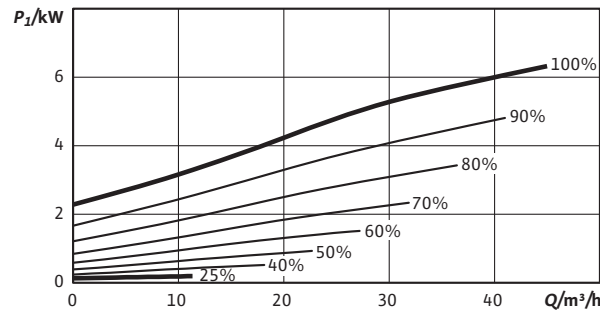
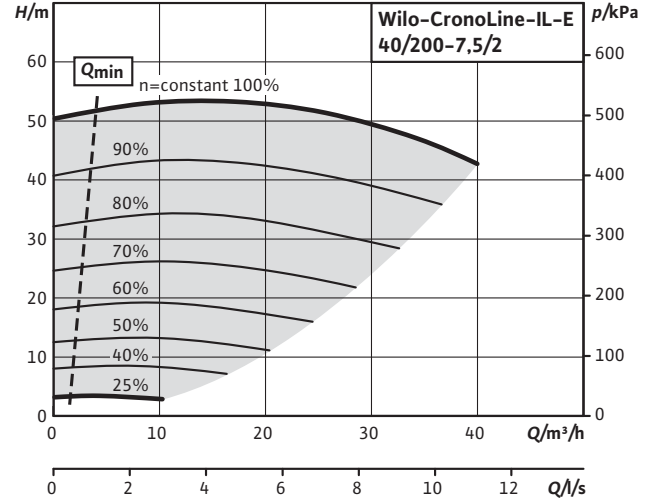
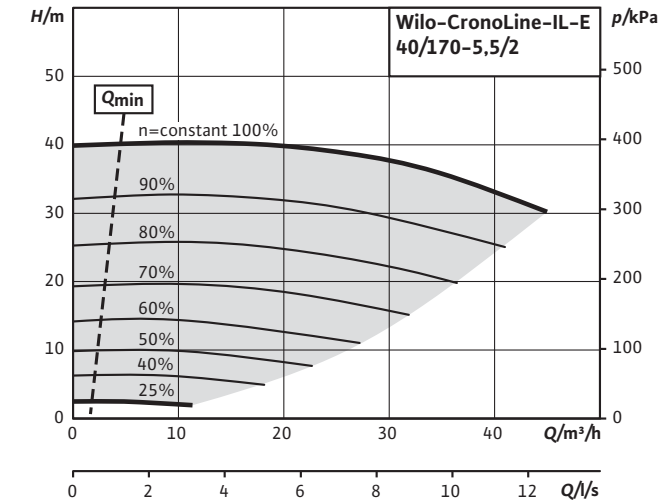

Riscaldamento, condizionamento e refrigerazione

Curve caratteristiche

CronoLine-IL-E 40/220-11/2 (2 poli)

Curve caratteristiche

CronoLine-IL-E 50/160-5,5/2 (2 poli)

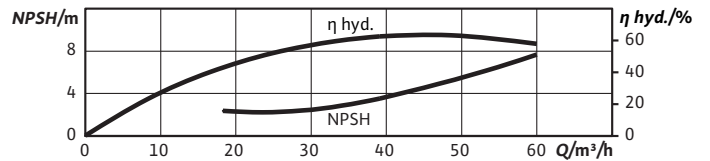
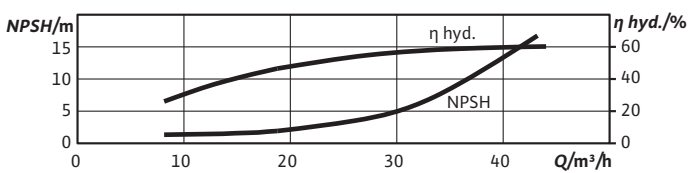
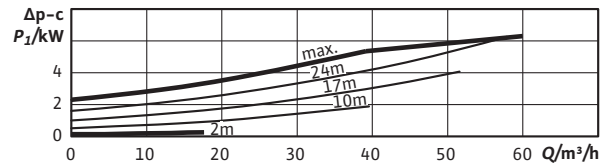
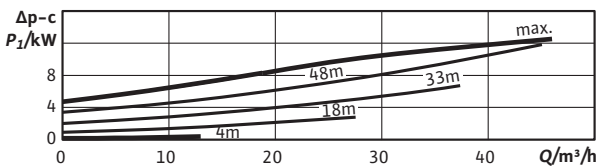
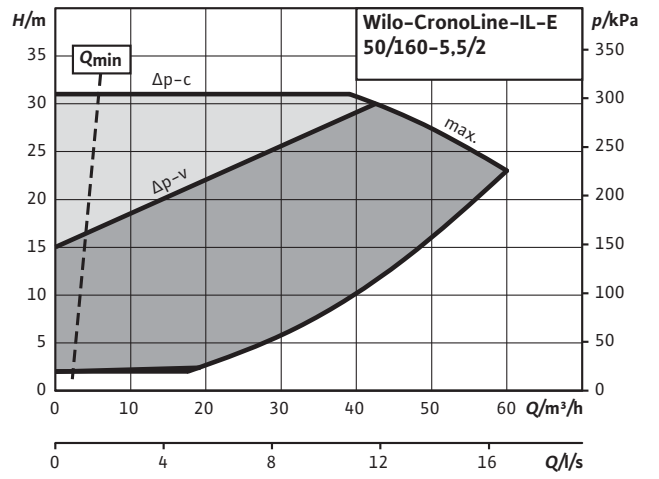
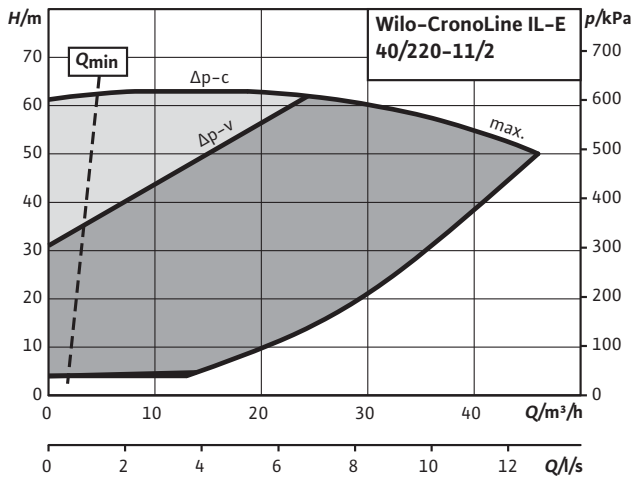
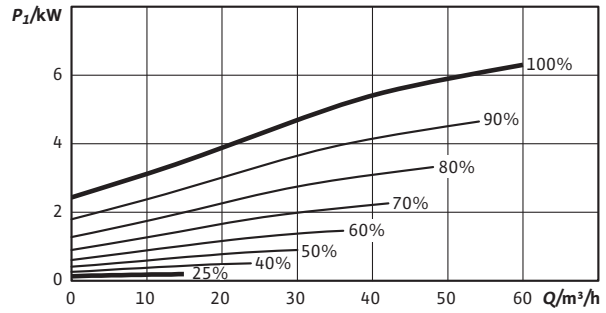
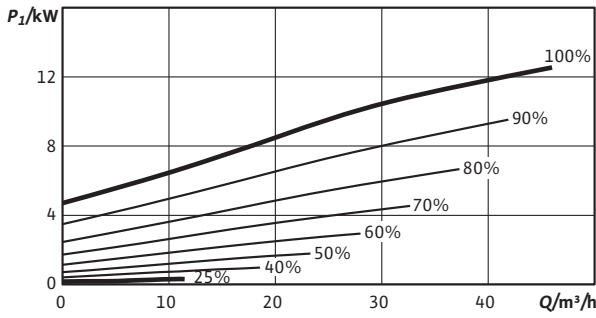
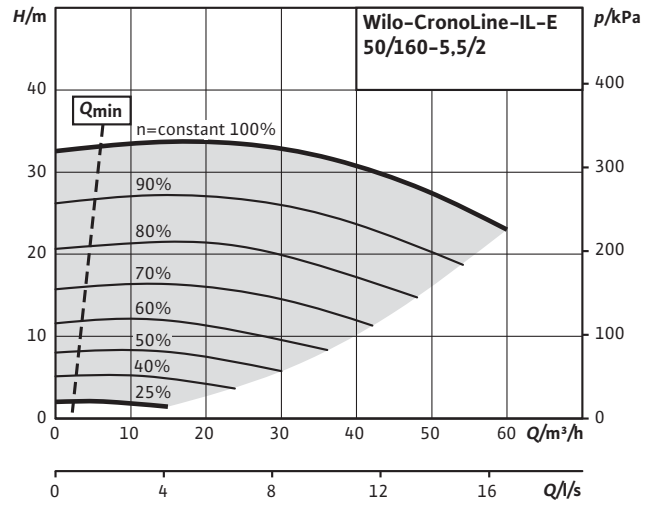
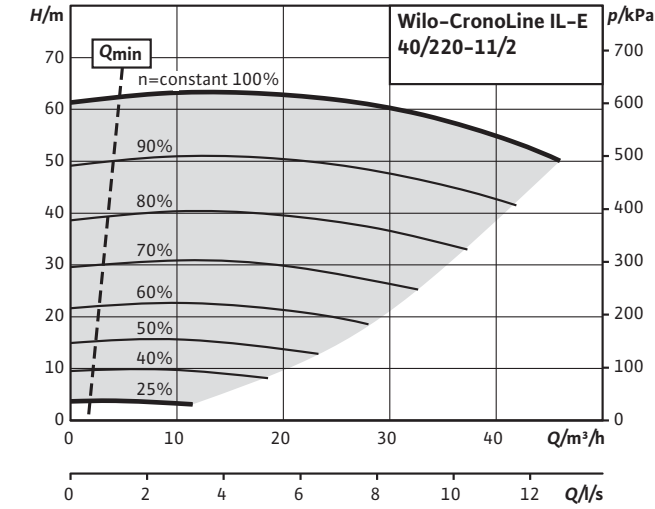

Curve caratteristiche

CronoLine-IL-E 50/170-7,5/2 (2 poli)

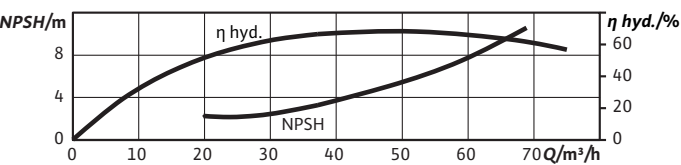
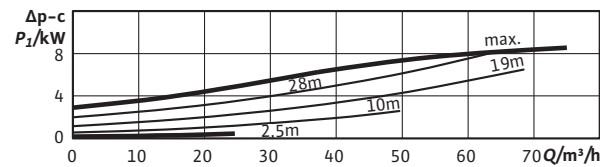
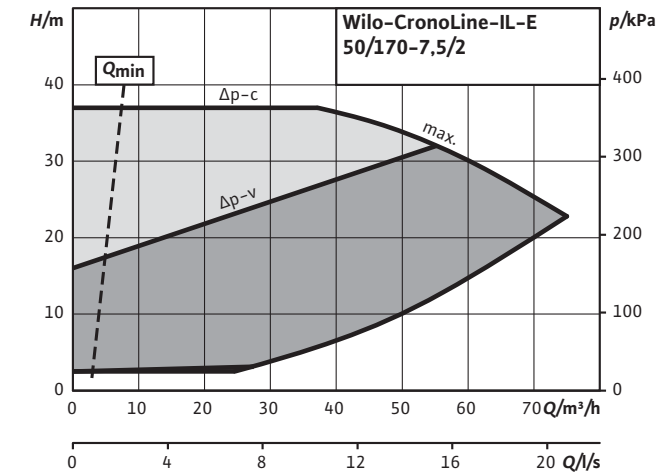
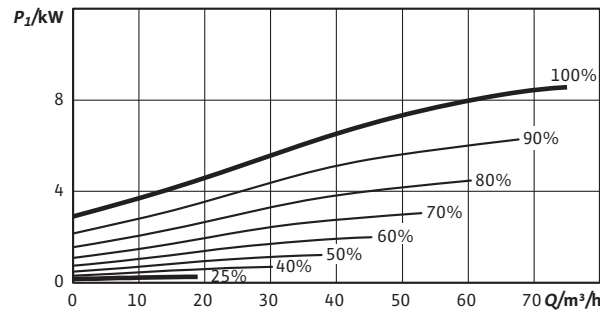
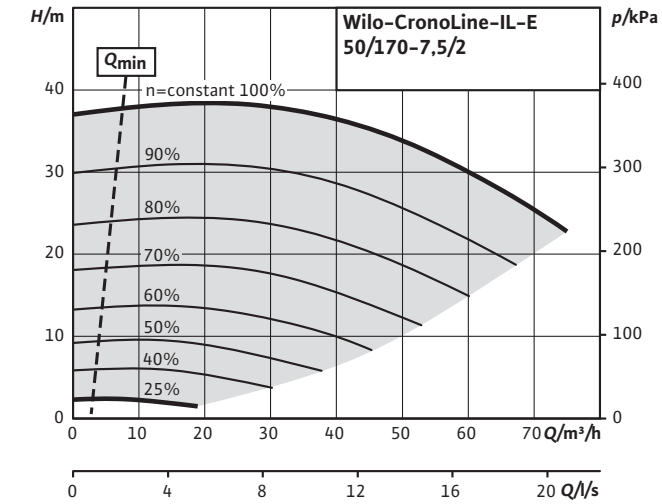

Curve caratteristiche

CronoLine-IL-E 50/180-7,5/2 (2 poli)

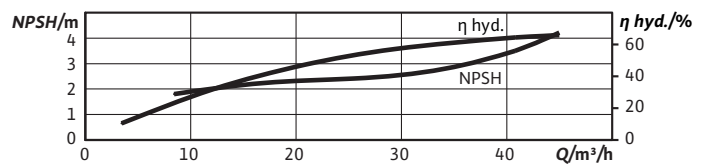
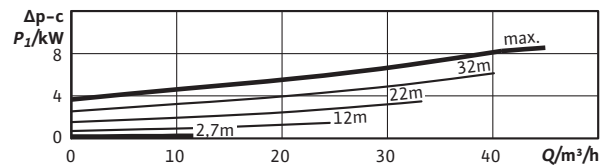
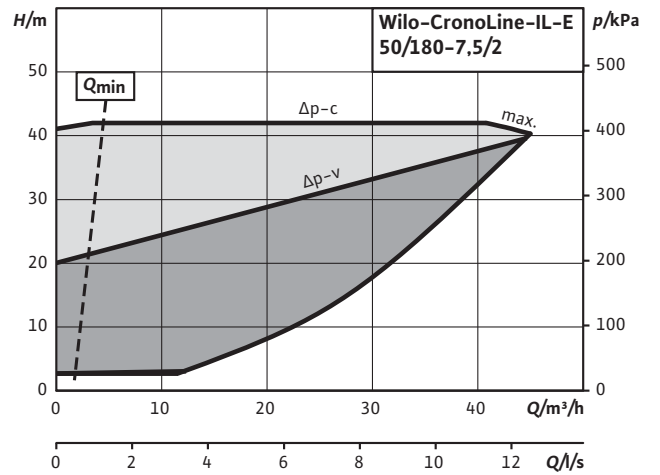
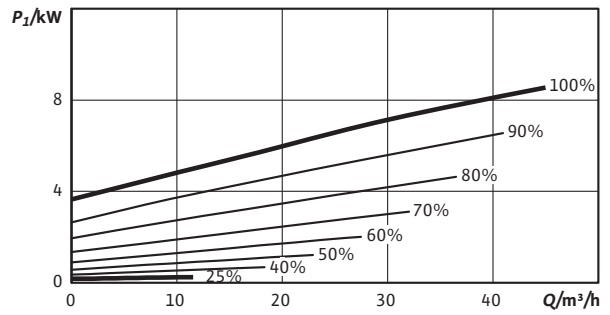
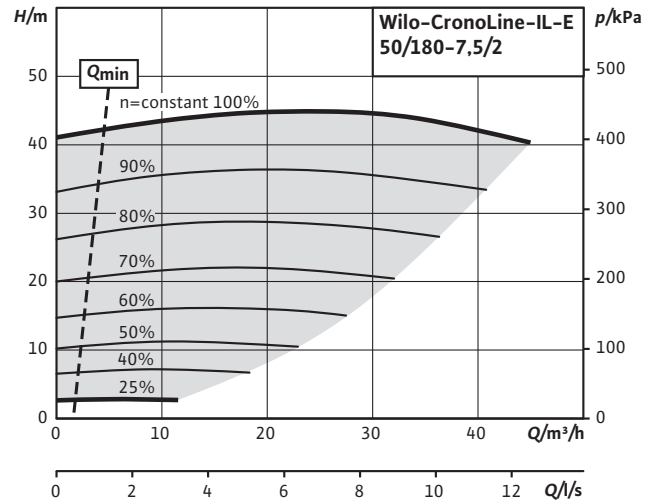

Riscaldamento, condizionamento e refrigerazione

Curve caratteristiche

CronoLine-IL-E 50/210-11/2 (2 poli)

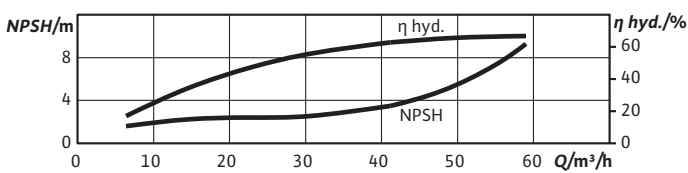
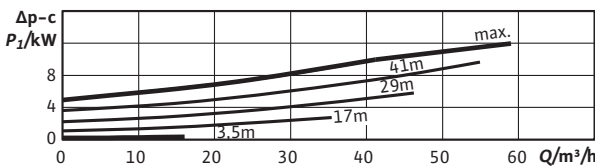
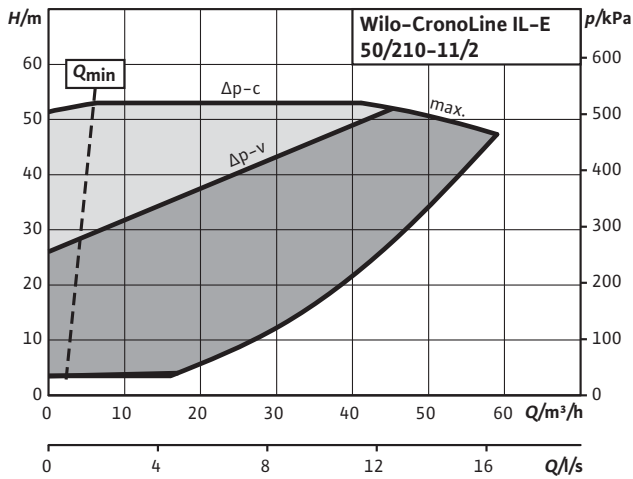
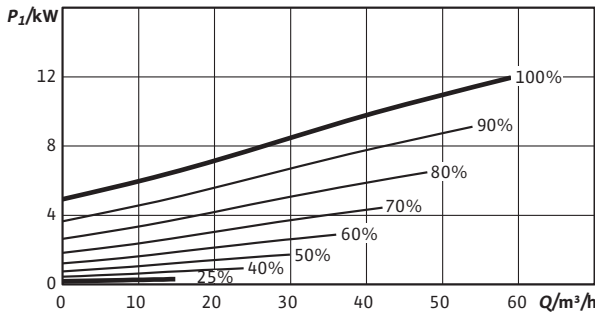
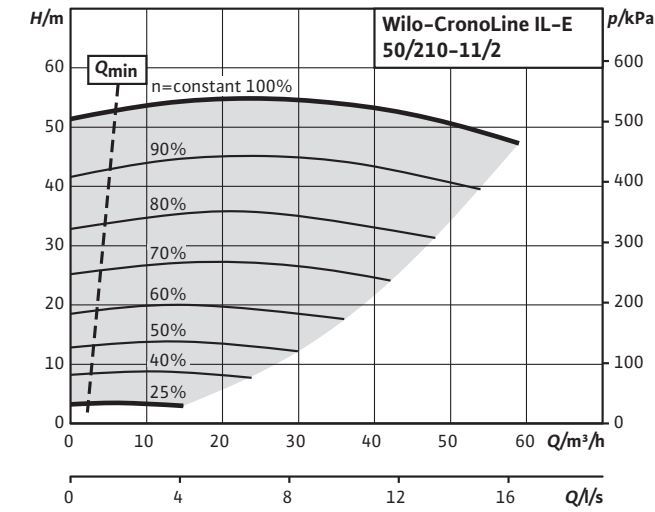

Curve caratteristiche

CronoLine-IL-E 50/220-15/2 (2 poli)

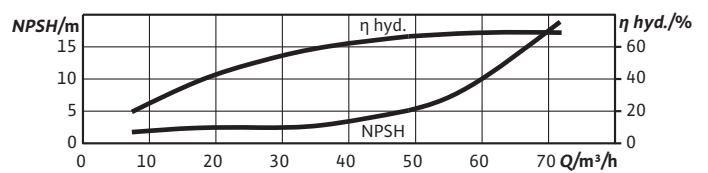
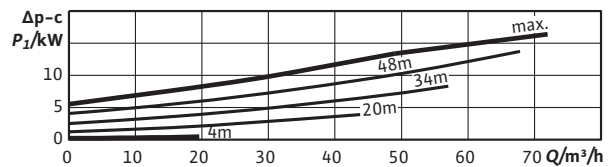
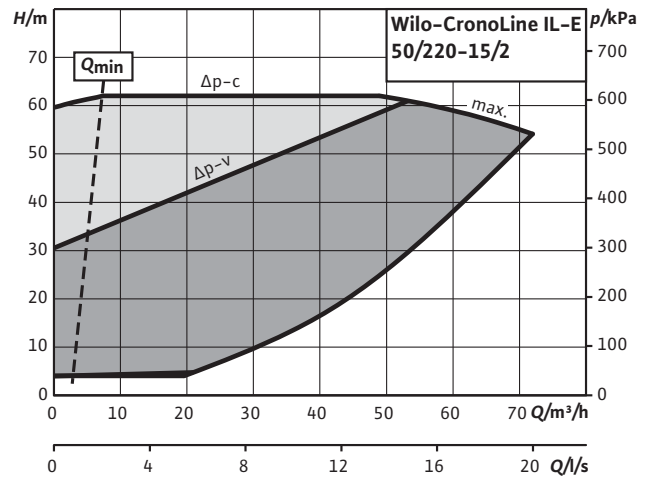
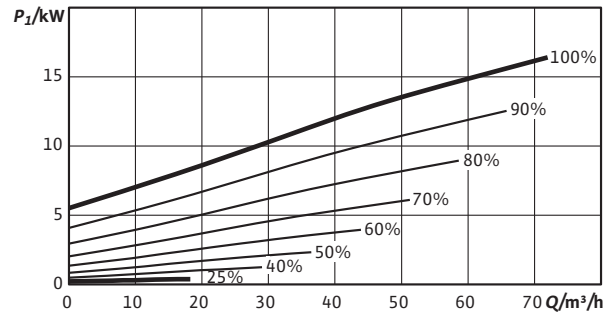
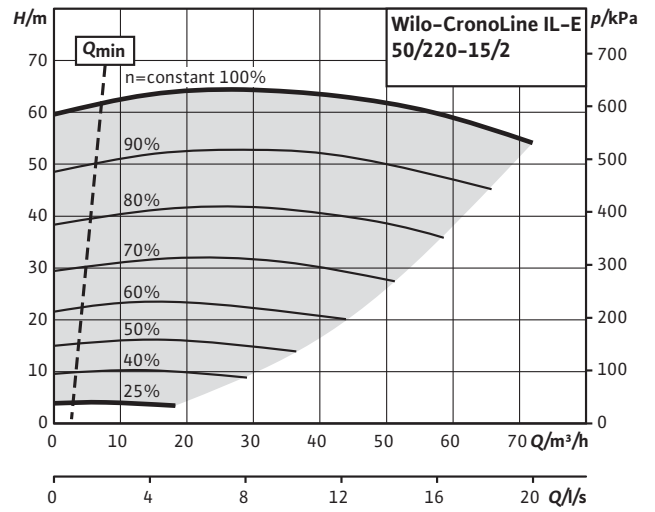



Curve caratteristiche

CronoLine-IL-E 65/150-5,5/2 (2 poli)

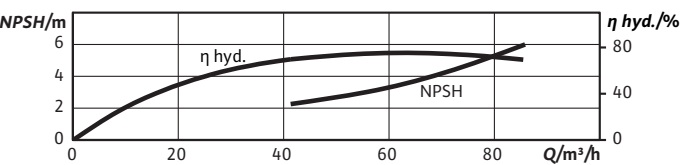
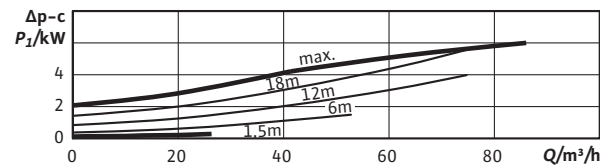
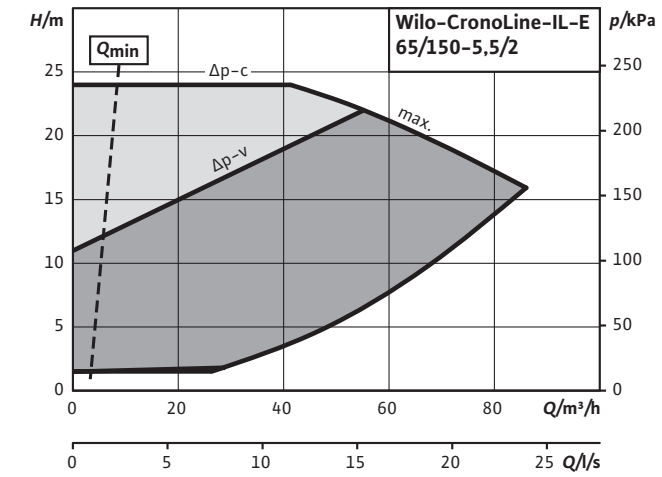
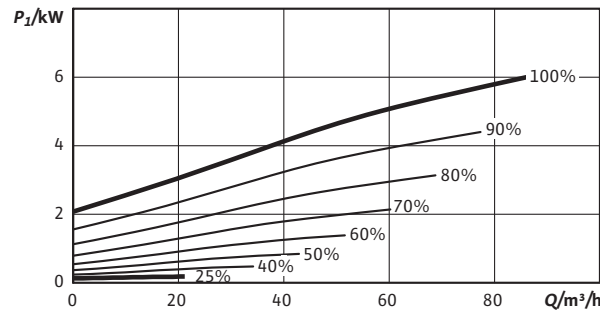
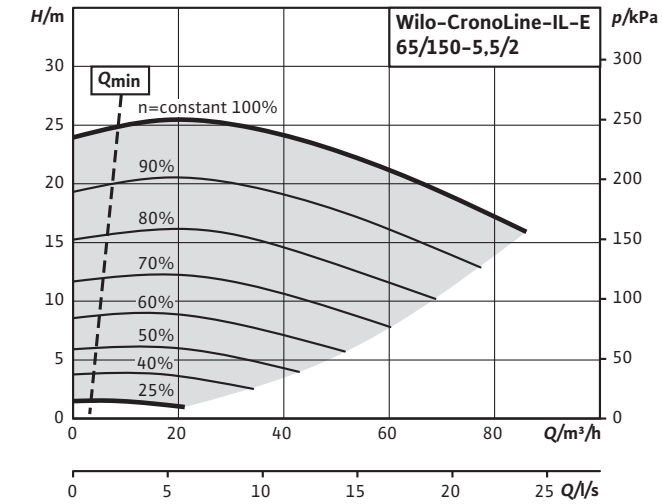

Curve caratteristiche

CronoLine-IL-E 65/160-7,5/2 (2 poli)

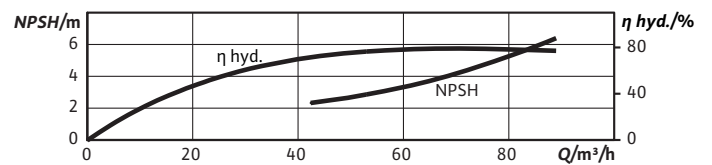
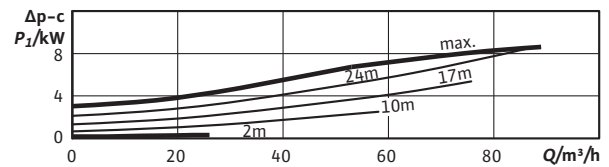
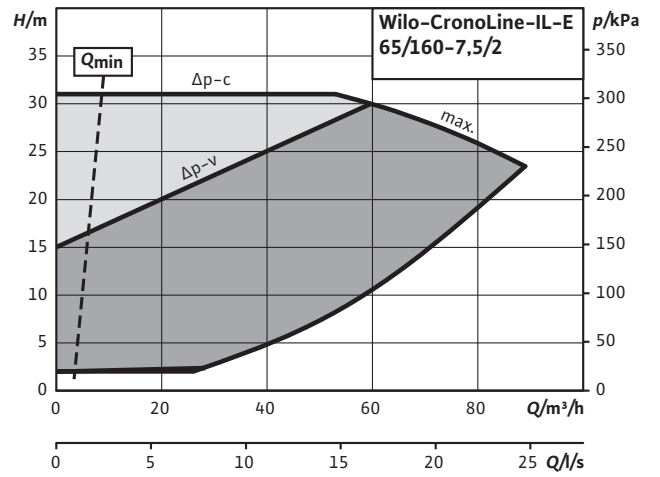
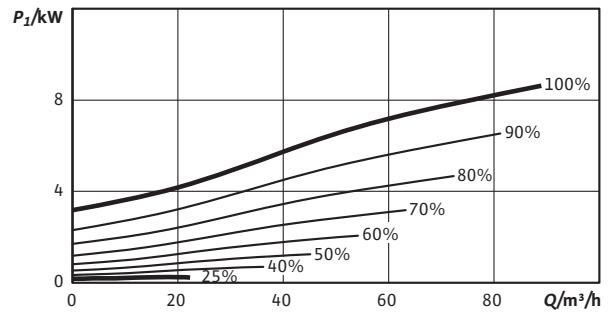
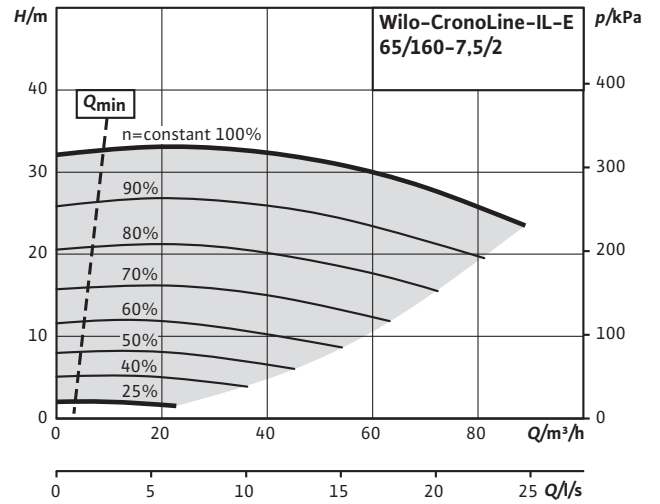

Riscaldamento, condizionamento e refrigerazione

Curve caratteristiche

CronoLine-IL-E 65/170-11/2 (2 poli)

Curve caratteristiche

CronoLine-IL-E 65/200-15/2 (2 poli)

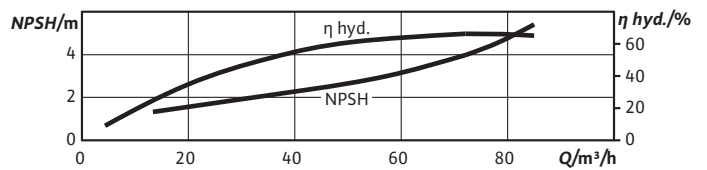
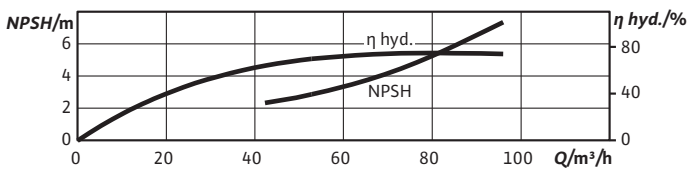
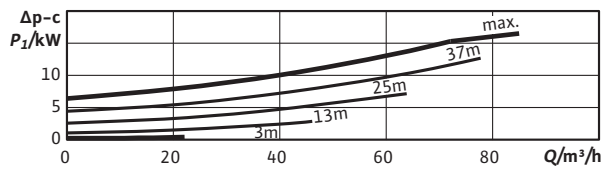
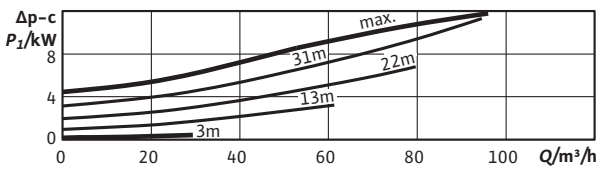
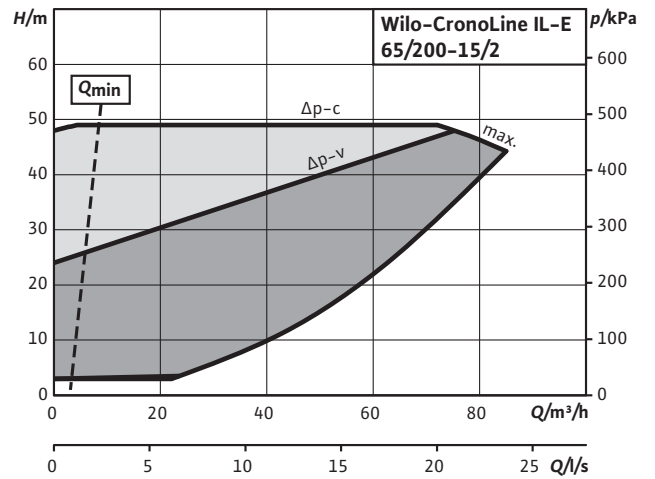
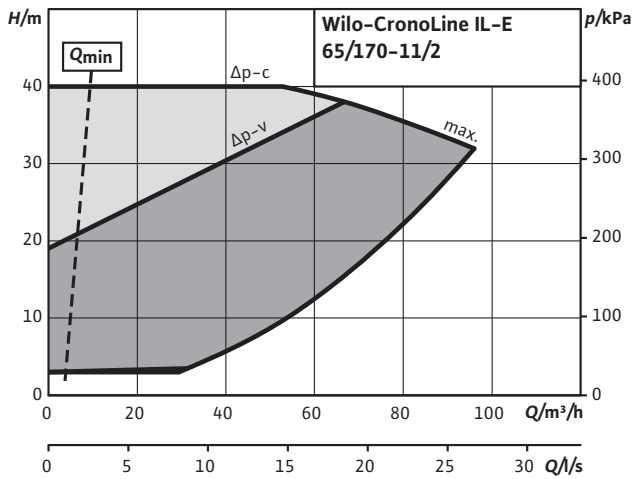
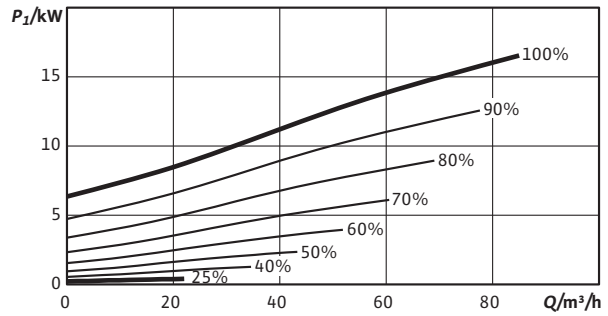
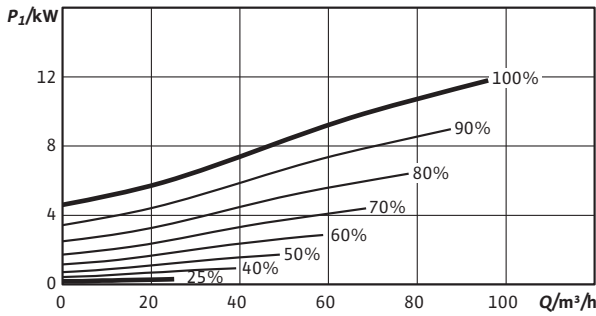
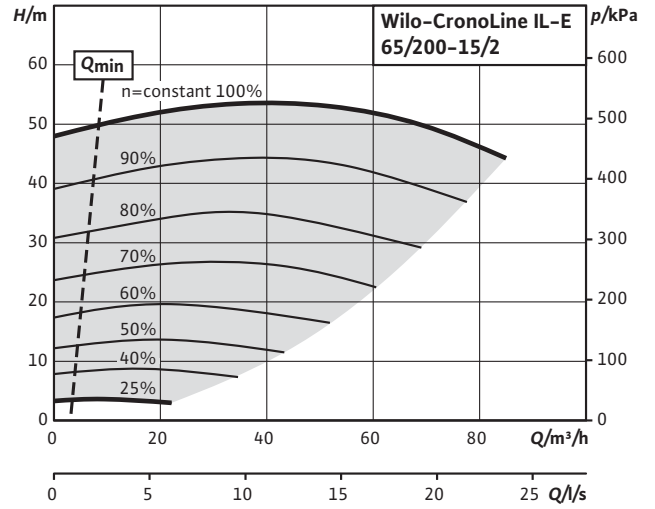
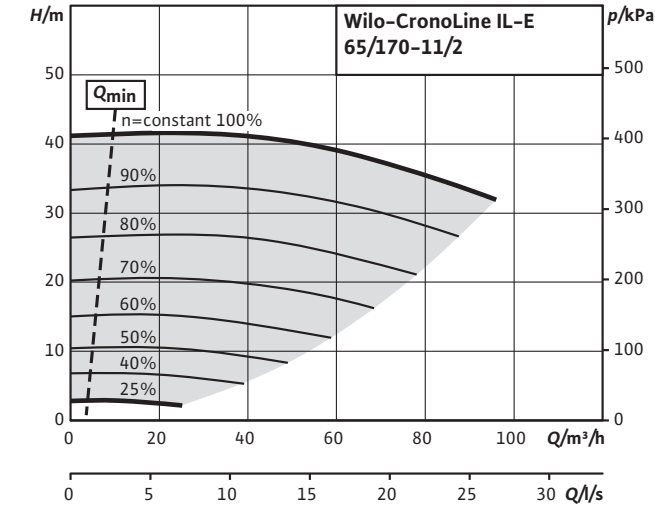

Curve caratteristiche

CronoLine-IL-E 65/210-18,5/2 (2 poli)

Curve caratteristiche

CronoLine-IL-E 65/220-22/2 (2 poli)

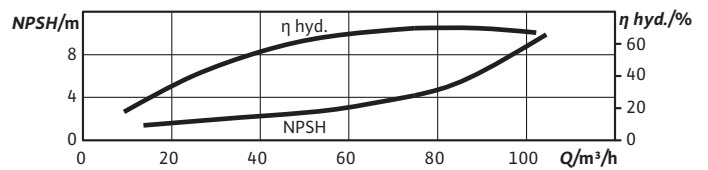
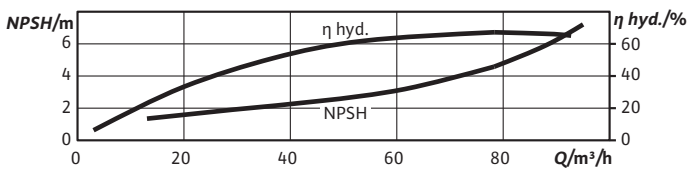
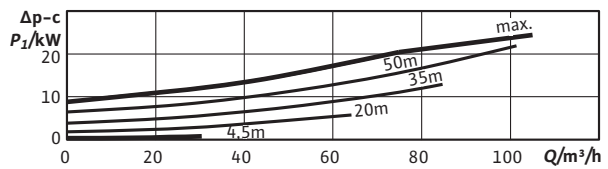
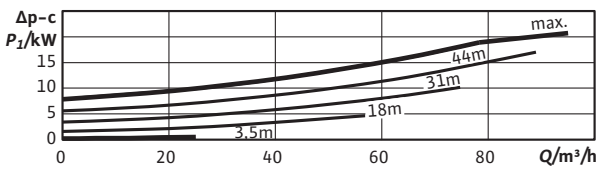
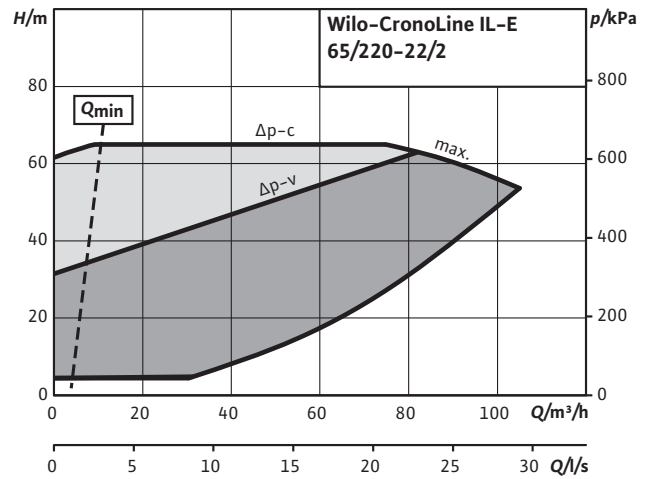
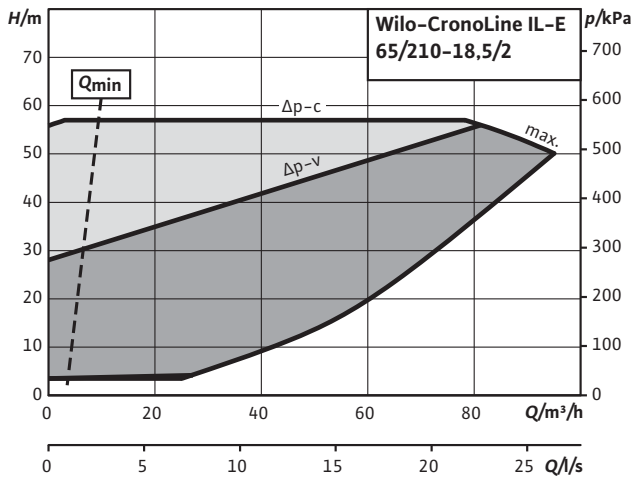
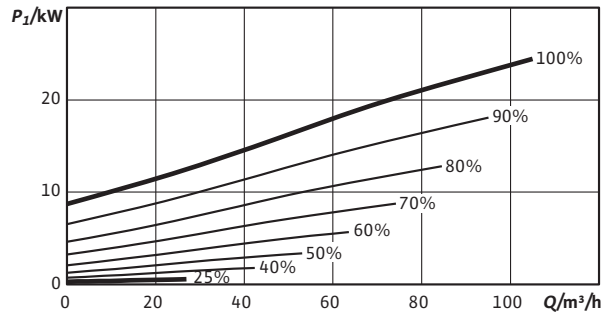
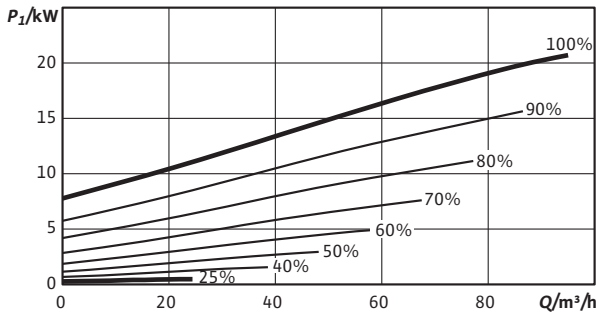
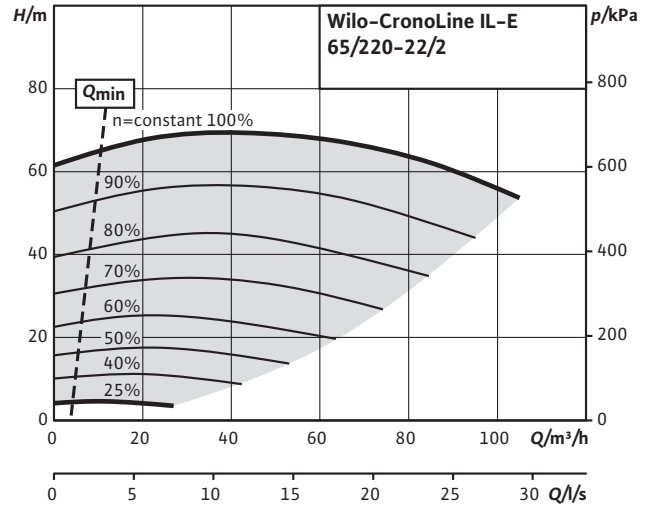
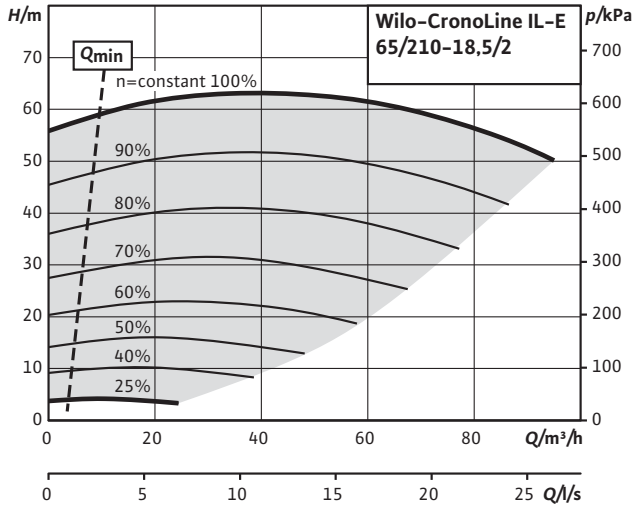

Riscaldamento, condizionamento e refrigerazione

Curve caratteristiche

CronoLine-IL-E 80/130-5,5/2 (2 poli)

Curve caratteristiche

CronoLine-IL-E 80/140-7,5/2 (2 poli)

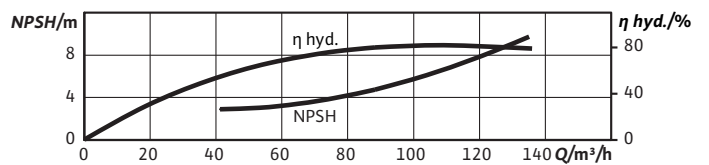
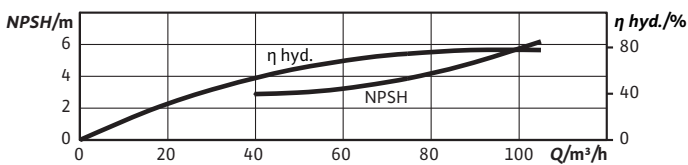
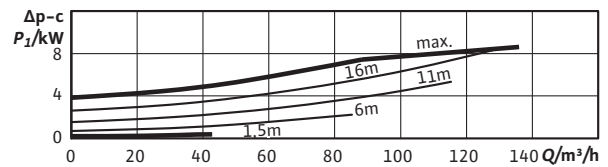
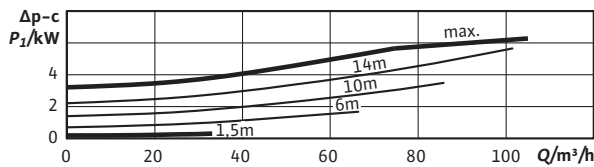
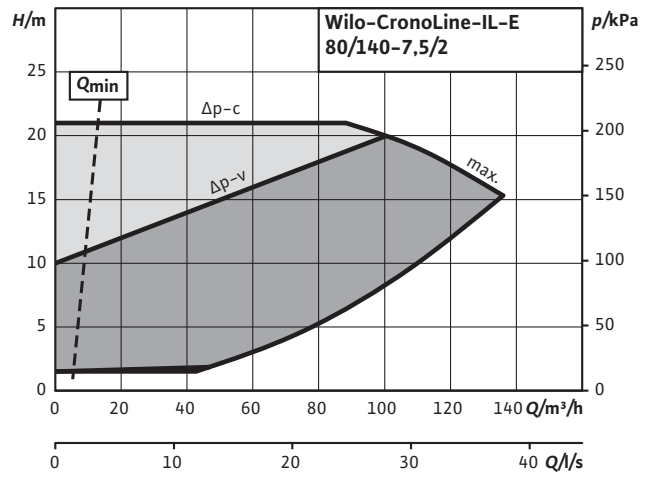
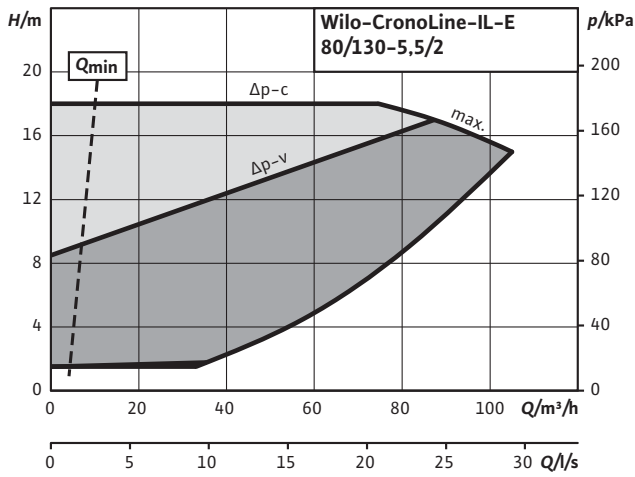
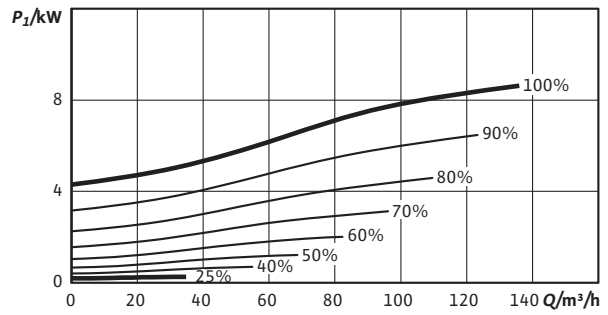
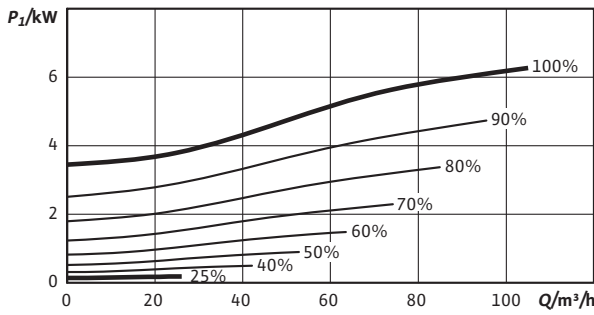
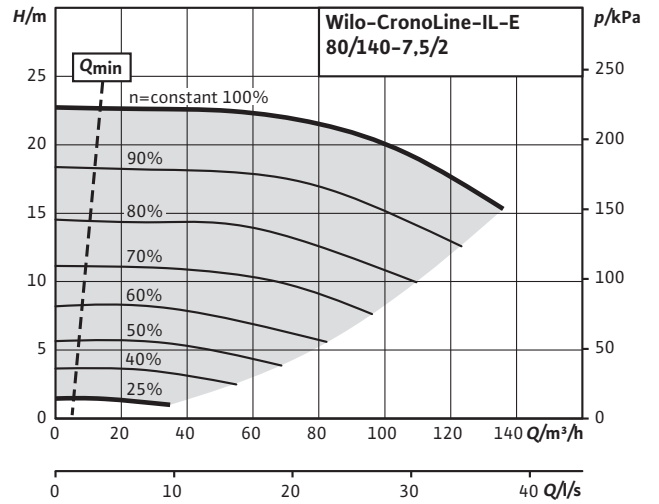
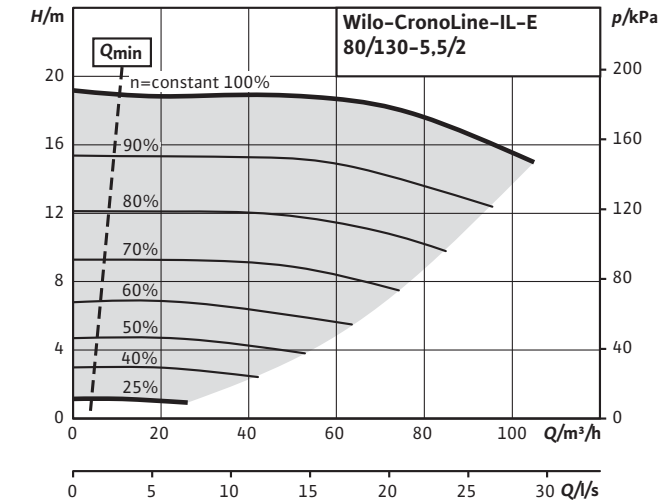

Curve caratteristiche

CronoLine-IL-E 80/150-7,5/2 (2 poli)

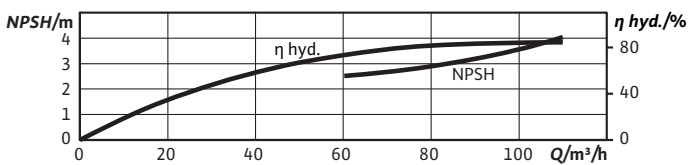
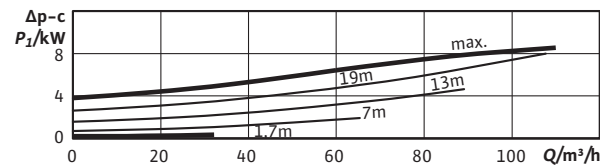
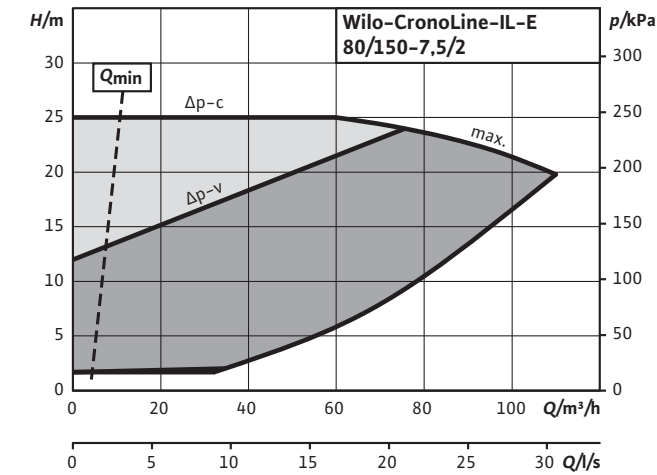
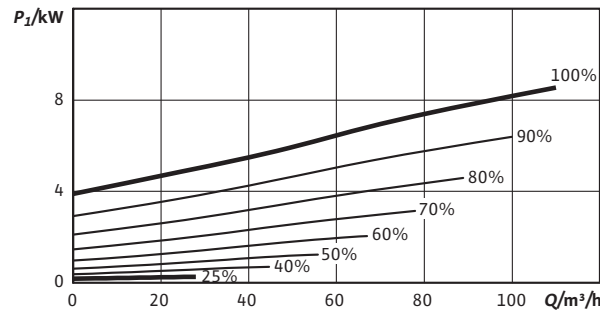
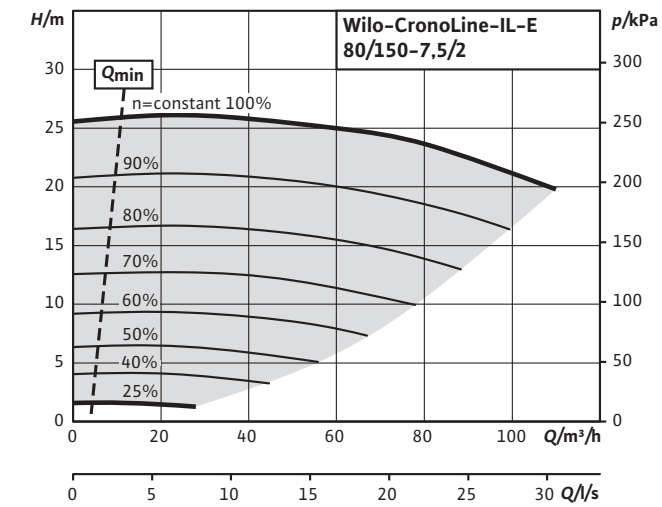

Curve caratteristiche

CronoLine-IL-E 80/160-11/2 (2 poli)

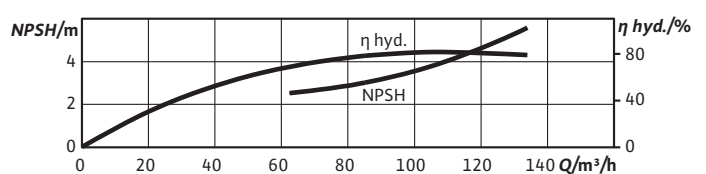
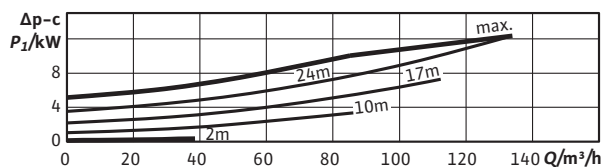
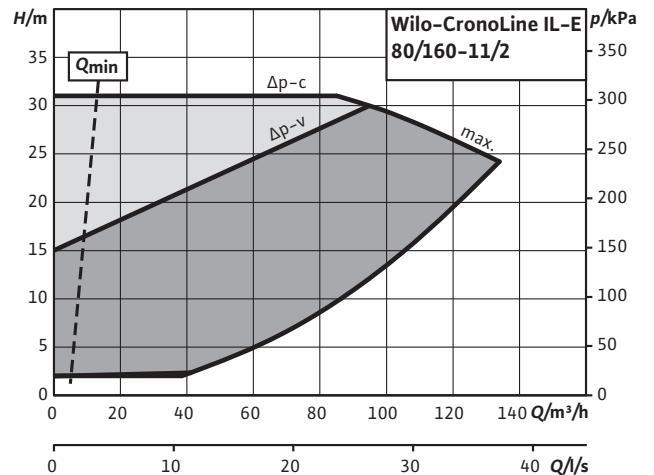
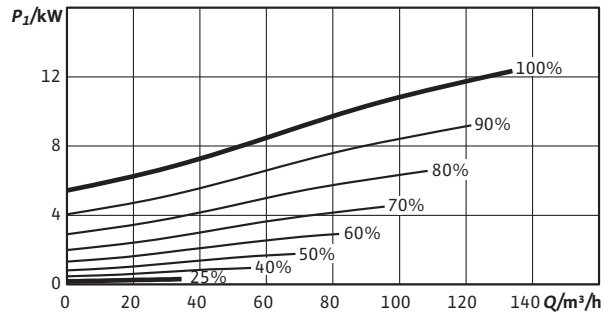
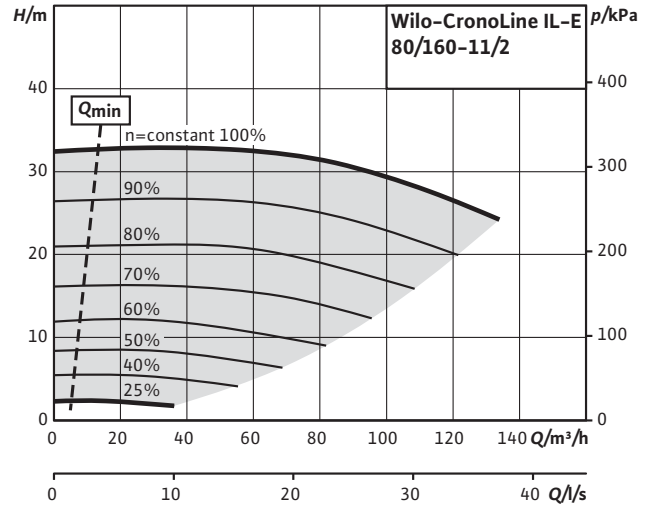

Riscaldamento, condizionamento e refrigerazione

Curve caratteristiche

CronoLine-IL-E 80/170-15/2 (2 poli)

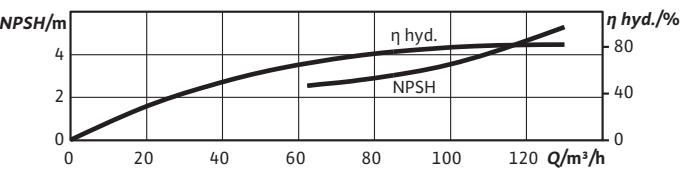
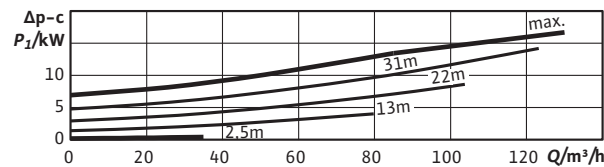
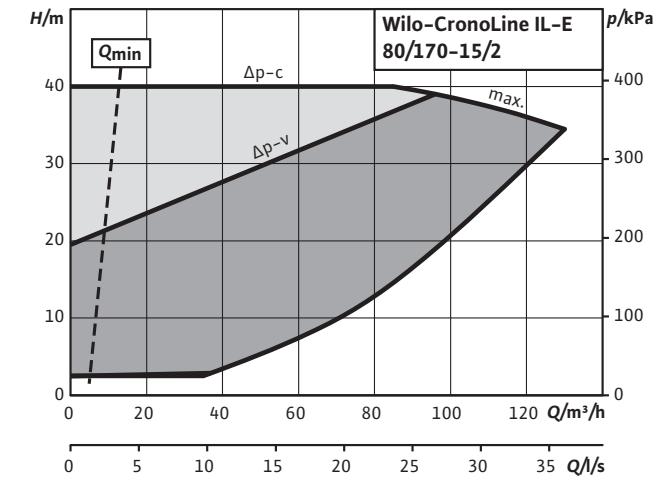
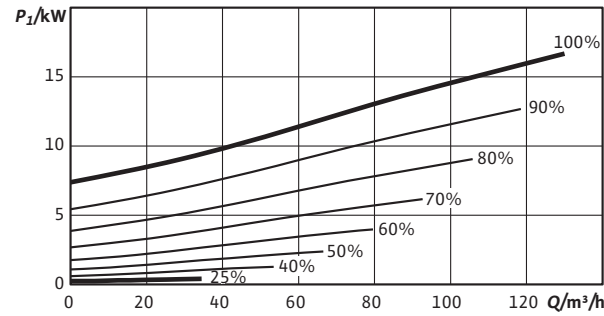
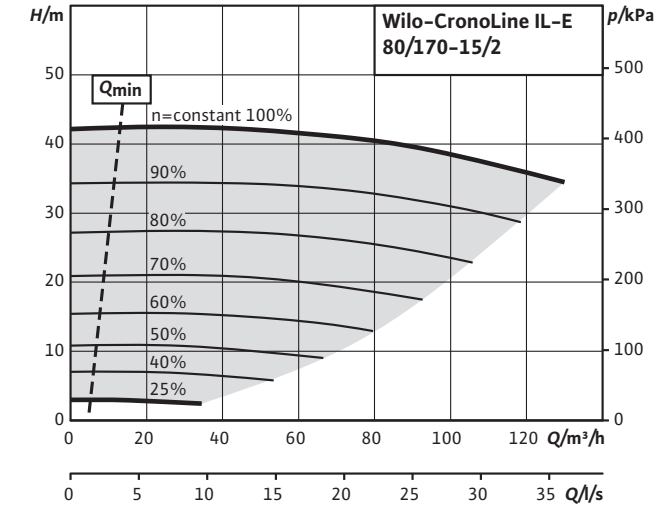

Curve caratteristiche

CronoLine-IL-E 80/190-18,5/2 (2 poli)

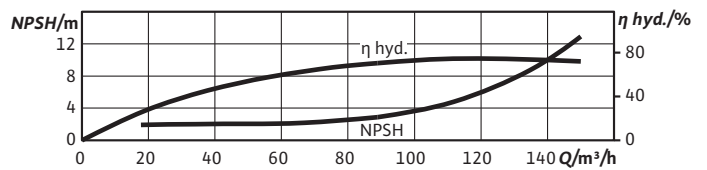
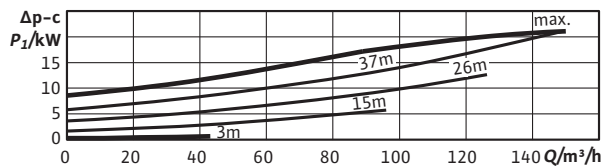
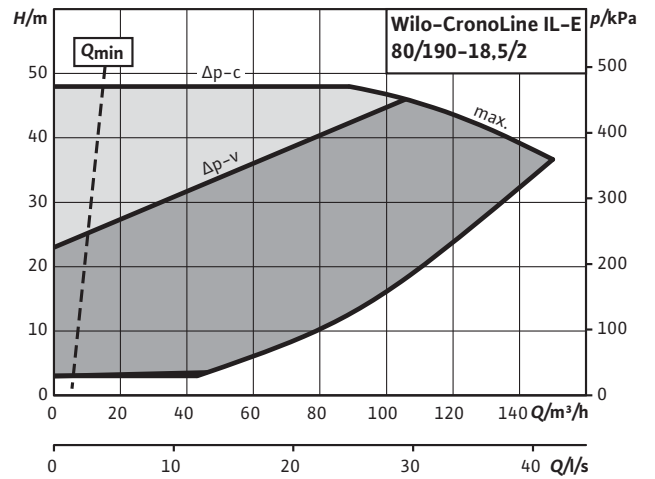
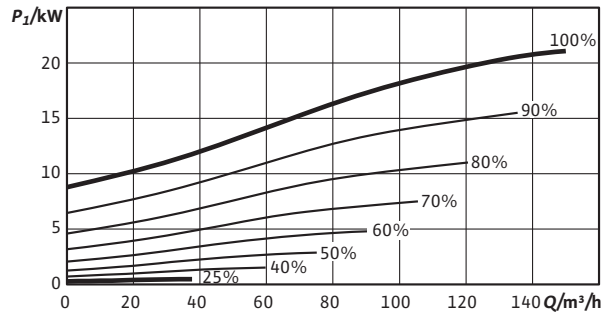
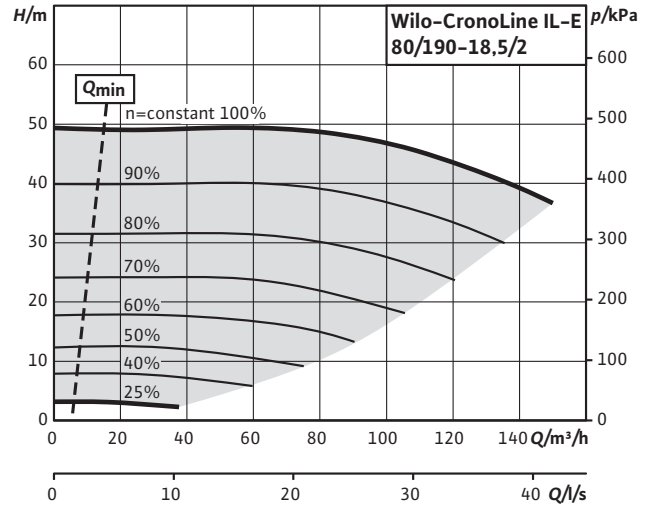

Curve caratteristiche

CronoLine-IL-E 80/200-22/2 (2 poli)

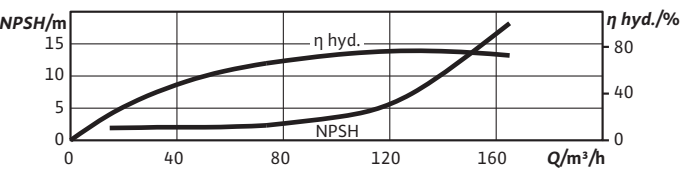
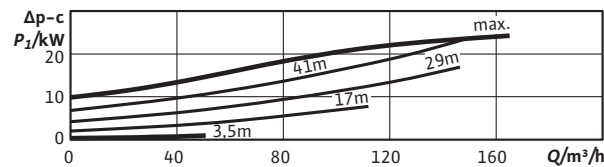
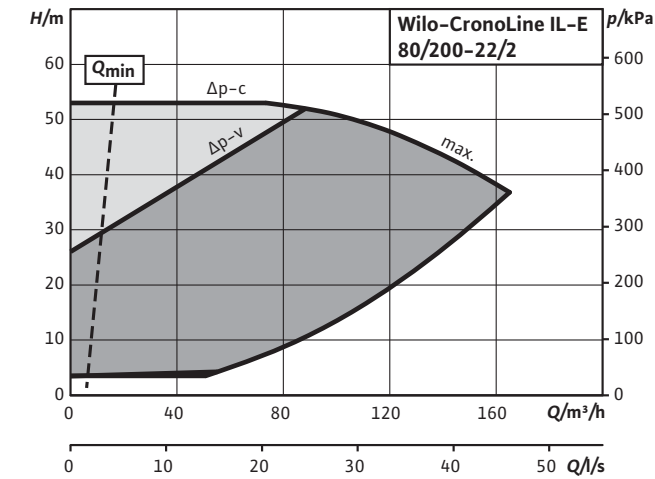
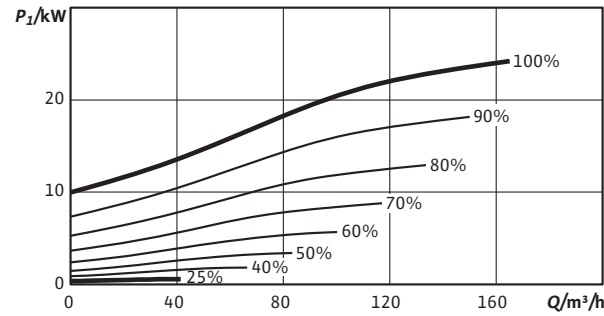
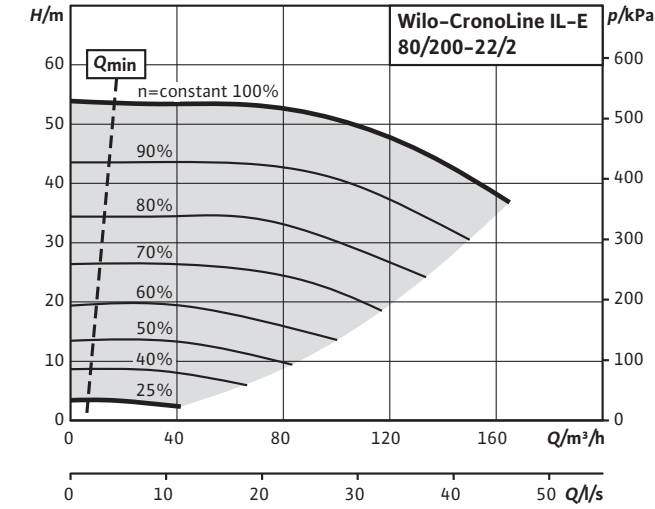

Curve caratteristiche

CronoLine-IL-E 100/145-11/2 (2 poli)

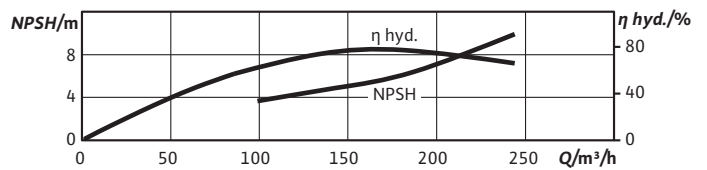
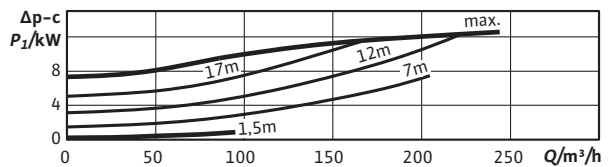
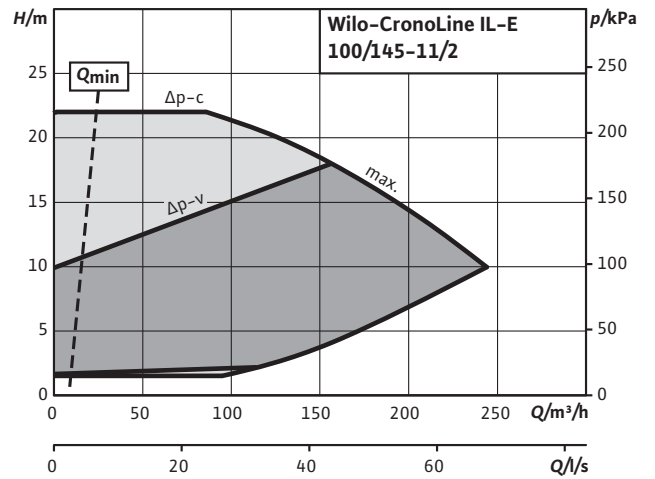
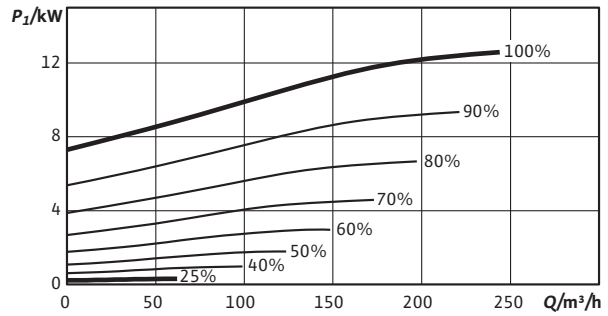
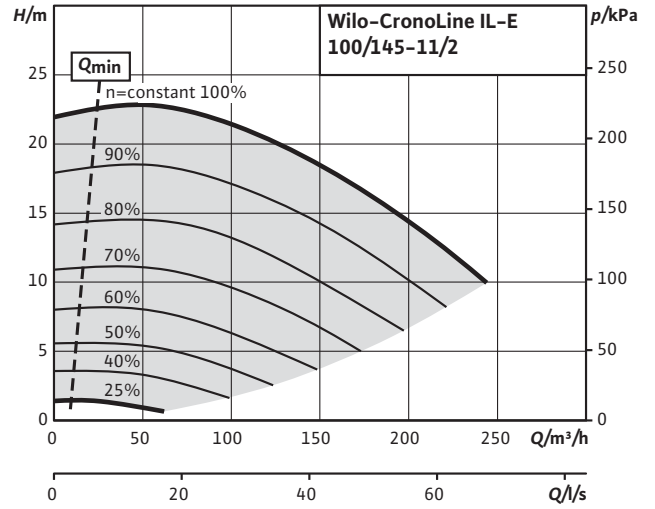

Riscaldamento, condizionamento e refrigerazione

Curve caratteristiche

CronoLine-IL-E 100/150-15/2 (2 poli)

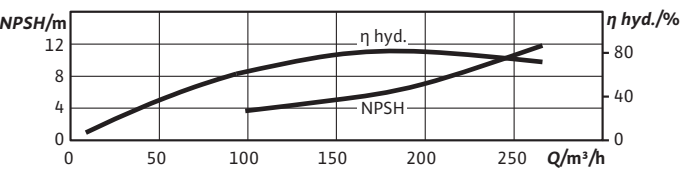
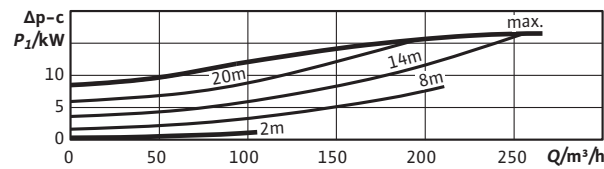
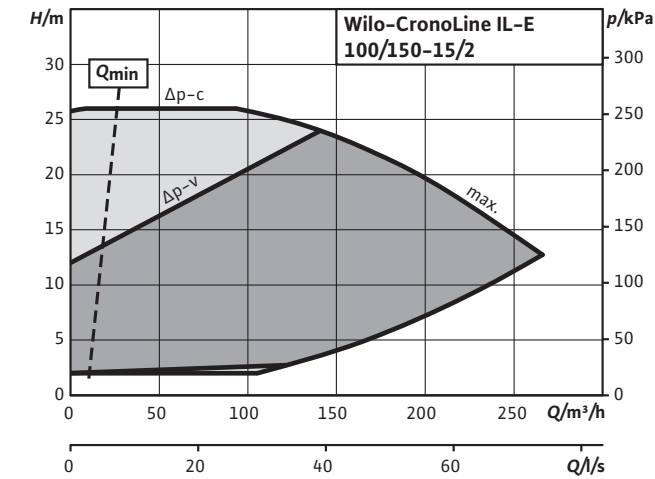
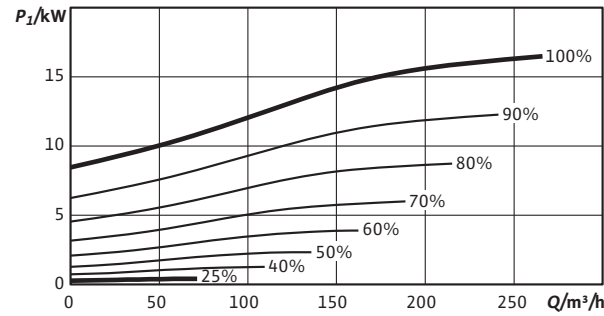
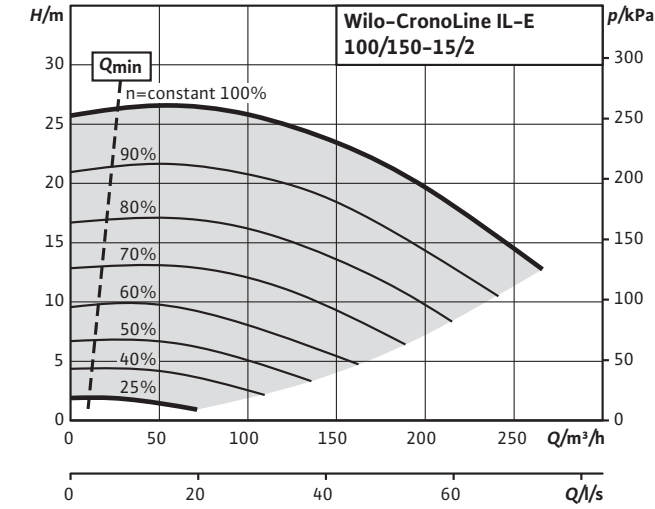

Curve caratteristiche

CronoLine-IL-E 100/160-18,5/2 (2 poli)

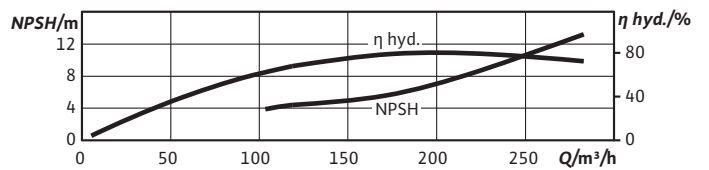
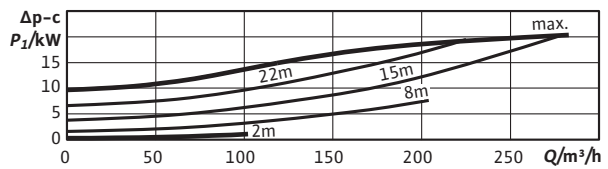
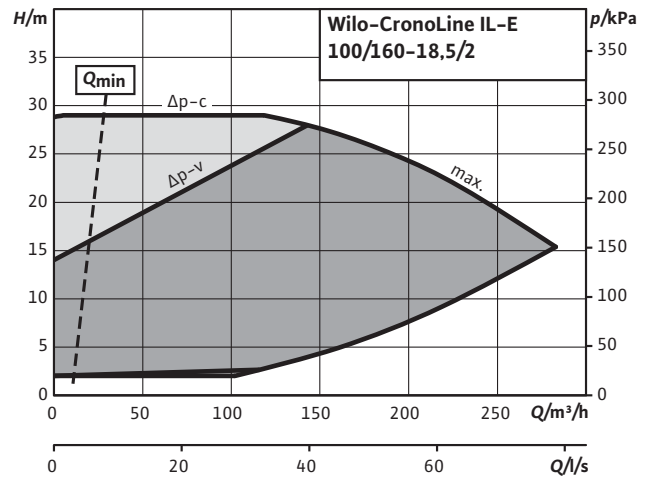
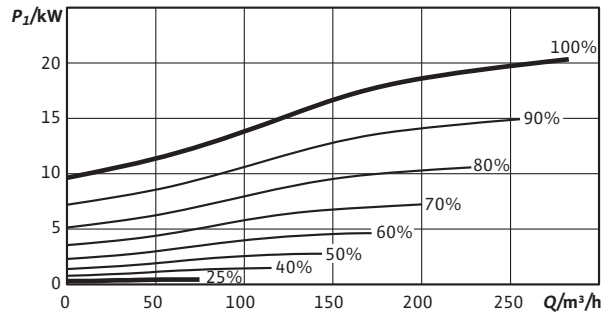
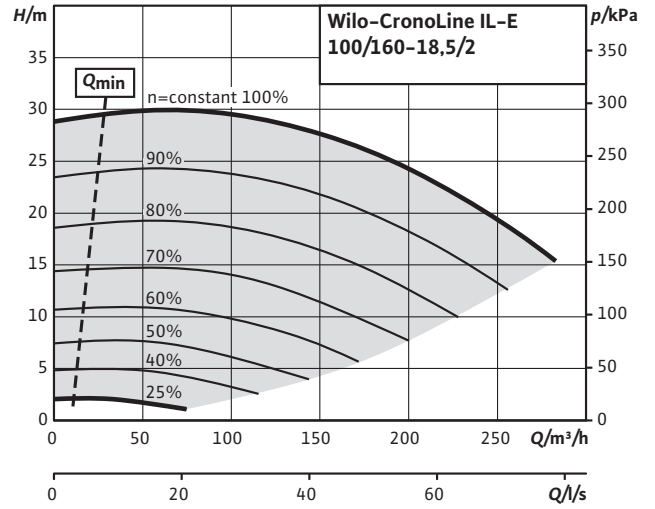



Curve caratteristiche

CronoLine-IL-E 100/165-22/2 (2 poli)

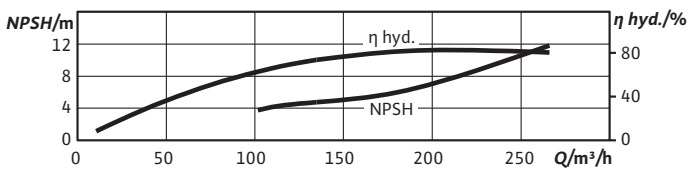
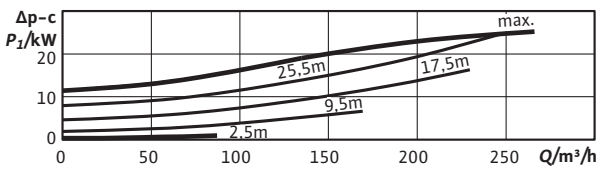
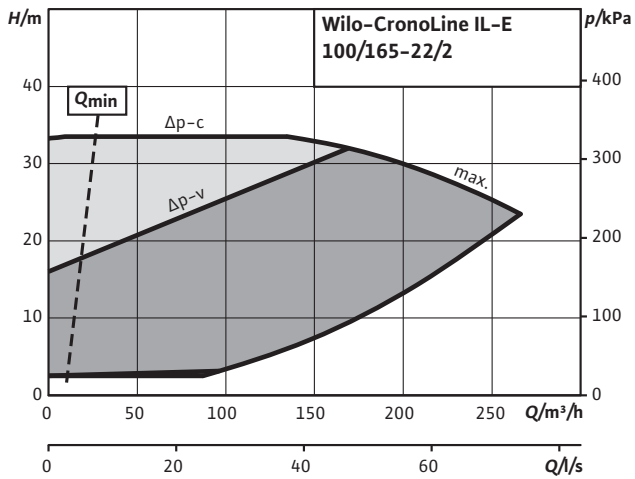
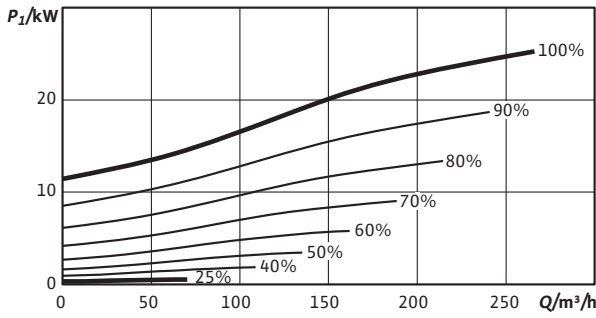
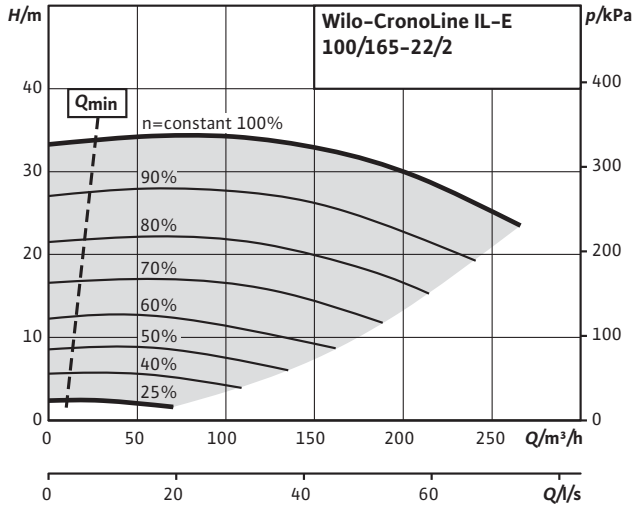

Riscaldamento, condizionamento e refrigerazione

## Disegno quotato

## SCHEMA DIMENSIONALE A

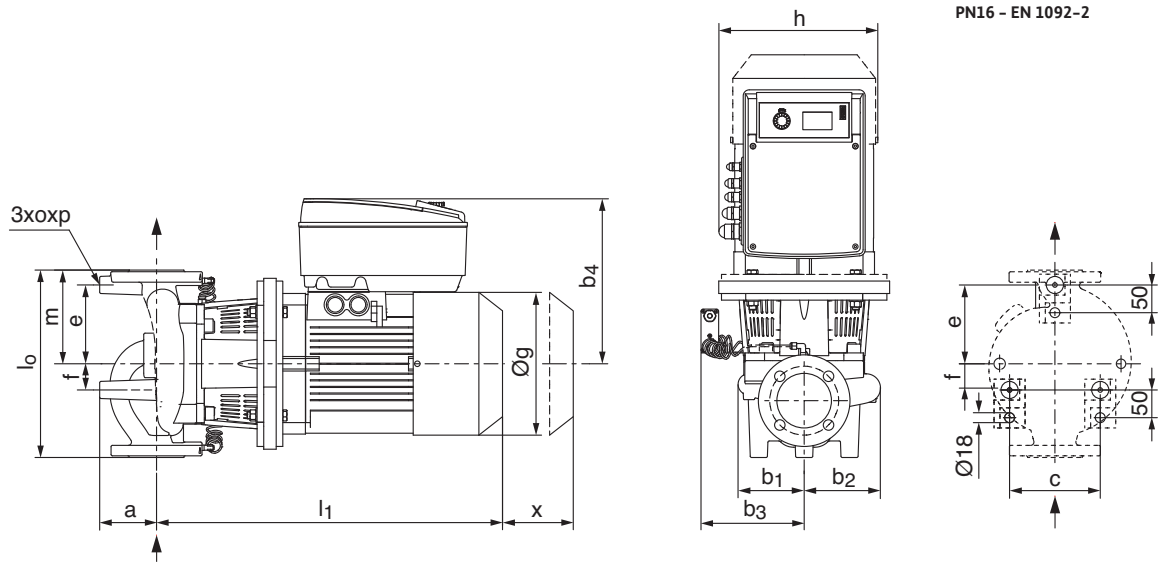

PN16 - EN 1092-2

## SCHEMA DIMENSIONALE B

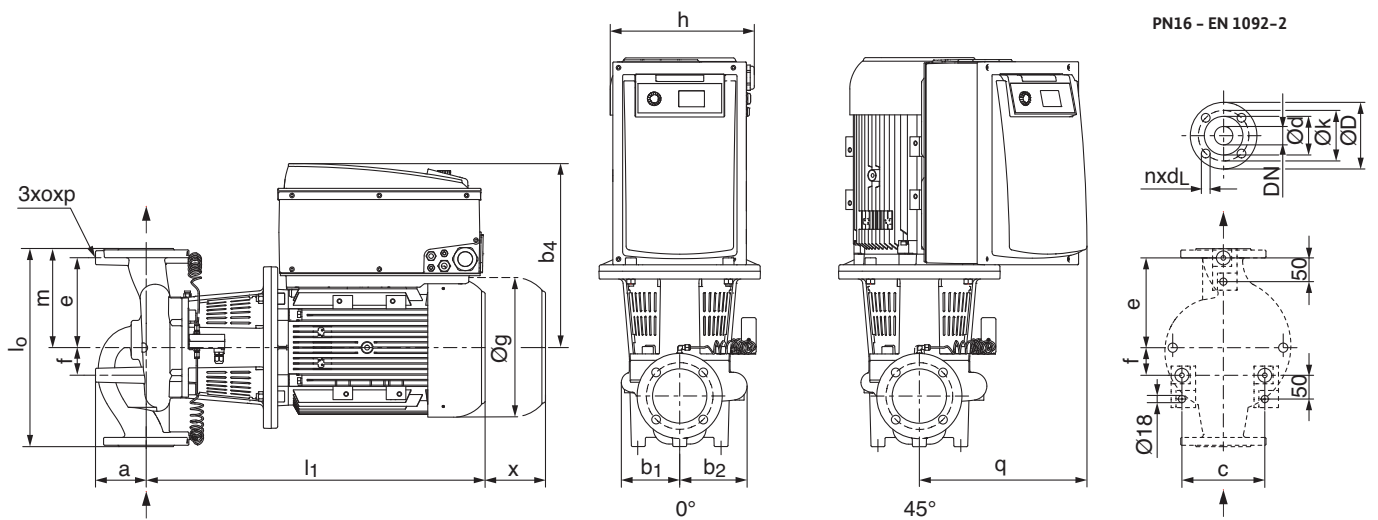

PN16 - EN 1092-2

## SCHEMA FLANGIE

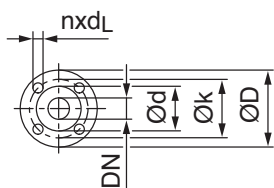

DN	Ø D	Ø k	Ø d	fori
	mm	mm	mm	n x Ø
40	150	110	84	4 x 19
50	165	125	99	4 x 19
65	185	145	118	4 x 19
80	200	160	132	8 x 19
100	220	180	156	8 x 19
125	250	210	184	8 x 19
150	285	240	211	8 x 23
200	340	295	266	12 x 23

Caratteristiche elettriche e dimensionamento

Modello	MOTORE		TRASD.	POMPA																	peso kg	Schema
	Potenza	Intensità	DDG	DN	a	b1	b2	b3	b4	h	l0	l1	c	e	f	m	x	Øg				
	P2	A			mm	mm	mm	mm	mm	mm	mm	mm	mm	mm	mm	mm	mm	mm	mm			
	kW																					
<b>4 poli</b>																						
IL-E 100/220-5,5/4	5,5	11	20-7	100	155	173	202	224	303	260	550	626	220	231	99	255	120	266	139	A		
IL-E 100/250-7,5/4	7,5	13.4	20-7	100	180	188	214	224	303	260	550	626	240	236	114	260	120	266	158	A		
IL-E 100/270-11/4	11	19.6	40-5	100	180	188	214	-	463	320	550	821	240	236	114	260	120	302	181	A		
IL-E 125/210-5,5/4	5,5	11	20-7	125	175	177	212	224	303	260	620	639	280	266	54	280	120	266	151	A		
IL-E 125/220-7,5/4	7,5	14	20-7	125	175	177	212	224	303	260	620	639	280	266	54	280	120	266	162	A		
IL-E 150/190-5,5/4	5,5	10.6	20-7	150	200	202	249	224	303	260	700	651	260	284	116	310	130	266	185	A		
IL-E 150/200-7,5/4	7,5	13.9	20-7	150	200	202	249	224	303	260	700	651	260	284	116	310	130	266	192	A		
IL-E 150/220-11/4	11	20.9	20-7	150	200	202	249	-	463	320	700	885	260	284	116	310	130	302	181	A		
IL-E 150/250-15/4	15	28	20-6	150	230	278	320	-	463	320	700	904	288	304	146	330	135	302	181	A		
IL-E 150/260-18,5/4	18,5	34.3	40-5	150	230	278	320	-	483	320	700	967	288	304	146	330	135	370	181	A		
IL-E 150/270-22/4	22	39.2	40-5	150	230	278	320	-	483	320	700	967	288	304	146	330	135	370	181	A		
IL-E 200/240-15/4	15	27.9	20-6	200	245	281	362	-	483	320	800	929	330	270	165	370	140	302	384	A		
IL-E 200/250-18,5/4	18,5	33.3	20-6	200	245	281	362	-	483	320	800	992	330	270	165	370	140	370	181	A		
IL-E 200/260-22/4	22	39	20-6	200	245	281	362	-	483	320	800	992	330	270	165	370	140	370	181	A		
<b>2 poli</b>																						
IL-E 40/170-5,5/2	5,5	11.2	40-6	40	82	113	129	-	303	260	340	624	130	149	58	170	95	266	100	A		
IL-E 40/200-7,5/2	7,5	14.6	60-2	40	110	145	149	-	303	260	440	629	180	172	75	190	100	266	117	A		
IL-E 40/220-11/2	11	18.7	100-1	40	110	145	149	-	441	320	440	772	180	172	75	190	100	305	197	A		
IL-E 50/160-5,5/2	5,5	11.0	40-6	50	103	120	138	-	303	260	340	631	164	143	48	170	100	266	104	A		
IL-E 50/170-7,5/2	7,5	14.3	40-6	50	103	120	138	-	303	260	340	631	164	143	48	170	100	266	108	A		
IL-E 50/180-7,5/2	7,5	14.5	60-2	50	120	145	150	-	303	260	440	630	160	170	70	190	100	266	121	A		
IL-E 50/210-11/2	11	19.2	60-1	50	120	145	150	-	441	320	440	773	160	170	70	190	100	305	209	A		
IL-E 50/220-15/2	15	25.8	100-1	50	120	145	150	-	441	320	440	773	160	170	70	190	100	305	209	A		
IL-E 65/150-5,5/2	5,5	11.1	40-6	65	110	126	146	-	303	260	430	637	180	195	60	215	120	266	110	A		
IL-E 65/160-7,5/2	7,5	14.5	40-6	65	110	126	146	-	303	260	430	637	180	195	60	215	120	266	114	A		
IL-E 65/170-11/2	11	18.8	40-5	65	110	126	146	425		320	430	789	180	195	60	215	120	305	187	B		
IL-E 65/200-15/2	15	26.5	60-1	65	130	150	168	-	441	320	475	782	200	225	50	245	110	305	215	A		
IL-E 65/210-18,5/2	18,5	33.0	60-1	65	130	150	168	-	463	320	475	842	200	225	50	245	110	350	258	A		
IL-E 65/220-22/2	22	38.4	100-1	65	130	150	168	-	463	320	475	842	200	225	50	245	110	350	267	A		
IL-E 80/130-5,5/2	5,5	11.5	20-7	80	105	123	151	-	303	260	400	652	180	173	57	200	120	266	109	A		
IL-E 80/140-7,5/2	7,5	14.4	40-6	80	105	123	151	-	303	260	400	652	180	173	57	200	120	266	113	A		
IL-E 80/150-7,5/2	7,5	14.5	40-6	80	120	136	162	-	303	260	440	634	180	173	72	200	120	266	121	A		
IL-E 80/160-11/2	11	20.0	40-5	80	120	136	162	425		320	440	786	180	173	72	200	120	305	194	B		
IL-E 80/170-15/2	15	25.8	40-5	80	120	136	162	425		320	440	786	180	173	72	200	120	305	202	B		
IL-E 80/190-18,5/2	18,5	33.0	60-1	80	145	157	182	-	463	320	500	850	220	208	62	230	120	350	263	B		
IL-E 80/200-22/2	22	37.7	60-1	80	145	157	182	-	463	320	500	850	220	208	62	230	120	350	273	B		
IL-E 100/145-11/2	11	20.7	40-5	100	120	159	197	425		320	500	821	200	226	60	250	135	305	220	B		
IL-E 100/150-15/2	15	26.0	40-5	100	120	159	197	425		320	500	881	200	226	60	250	135	305	262	B		
L-E 100/160-18,5/2	18,5	32.5	40-5	100	120	159	197	425		320	500	881	200	226	60	250	135	350	272	B		
L-E 100/165-22/2	22	40.0	40-5	100	120	159	197	425		320	500	860	200	226	60	250	135	350	276	B		

Riscaldamento, condizionamento e refrigerazione

# Wilo-CronoTwin DL-E

Pompa gemellare a motore ventilato regolata elettronicamente

Per impianti di riscaldamento, condizionamento e refrigerazione commerciali ed industriali.



## Esecuzione

Pompe gemellari complete di trasduttore di pressione differenziale



## Efficienza

Motore elettrico normalizzato in classe di efficienza IE4 con accoppiamento con giunto rigido in esecuzione 2 e 4 poli



## Idraulica

Pompa con lanterna e giunto rigido per accoppiamento con motore normalizzato, tenuta meccanica standard.



Per maggiori informazioni sui prodotti:  
[www.wilo.it](http://www.wilo.it)



### Focus

- Efficienza idraulica  $MEI > 0,4$   
(secondo Direttiva ErP Regolamento CE n.547/2012)
- Efficienza motore IE4 (secondo IEC TS 60034-31 Ed.1)

### Vantaggi

- Campo di regolazione fino a tre volte maggiore delle pompe tradizionali regolate elettronicamente
- Con le interfacce seriali WILO-IF si integra con qualsiasi sistema di automazione degli edifici (BMS)

### In evidenza

Il display LCD di grandi dimensioni permette di visualizzare rapidamente i dati di SET della pompa.



### Tecnologia

La tecnologia 'pulsante rosso' rende la regolazione e l'installazione della pompa semplice e rapida.



### Installazione

I moduli WILO-IF permettono la connessione a tutte le reti di Building Management System.





Modifica della serie



## Wilo-CronoTwin-DL-E, efficace



### Chiave di lettura

Esempio	<b>DL-E 50/170-7,5/2-R1</b>
<b>DL-E</b>	Pompa doppia inline con regolazione elettronica
<b>50</b>	Diametro nominale DN della bocca
<b>170</b>	Diametro nominale della girante
<b>7,5</b>	Potenza nominale del motore P <sub>2</sub> in kW
<b>2</b>	Numero poli
<b>R1</b>	Versione senza sensore di pressione

### Particolarità/vantaggi del prodotto

- Motore elettrico IE4
- Risparmio energetico grazie alla regolazione della velocità integrata
- WILO-Moduli-IF opzionale per l'integrazione in sistemi di building automation
- Tecnologia del pulsante rosso e display per un semplice utilizzo
- Management integrato pompa doppia
- Protezione integrale del motore

Dati tecnici	
Indice di efficienza minimo (MEI)	≥ 0,4
<b>Fluidi consentiti (altri fluidi su richiesta)</b>	
Acqua riscaldamento (secondo VDI 2035)	Si
Miscela acqua/glicole (con 20-40 % vol. di glicole e temperatura fluido ≤ 40 °C)	Si
Acqua fredda e refrigerata	Si
Olio diatermico	Versione speciale
<b>Campo d'applicazione consentito</b>	
Campo di temperatura con una temperatura ambiente max. di +40 °C	-20...+140 °C (a seconda del fluido di pompaggio)
Pressione nominale PN	13 bar (fino a +140 °C) 16 bar (fino a +120 °C)
<b>Alimentazione elettrica</b>	
Alimentazione rete	3~440V ±10%, 50/60 Hz 3~400V ±10%, 50/60 Hz 3~380V -5%/+10%, 50/60 Hz

Dati tecnici	
<b>Motore/elettronica</b>	
Indice di efficienza motore elettrico	IE4
Protezione integrale del motore	Si
Grado protezione	IP 55
Classe isolamento	F
Emissione disturbi	EN 61800-3
Immunità	EN 61800-3
<b>Materiali</b>	
Corpo pompa	EN-GJL-250
Lanterna	EN-GJL-250
Girante	EN-GJL-200
Girante (versione speciale)	G-CuSn10
Albero della pompa	1.4122
Tenuta meccanica	AQEGG
Altre tenute meccaniche	su richiesta

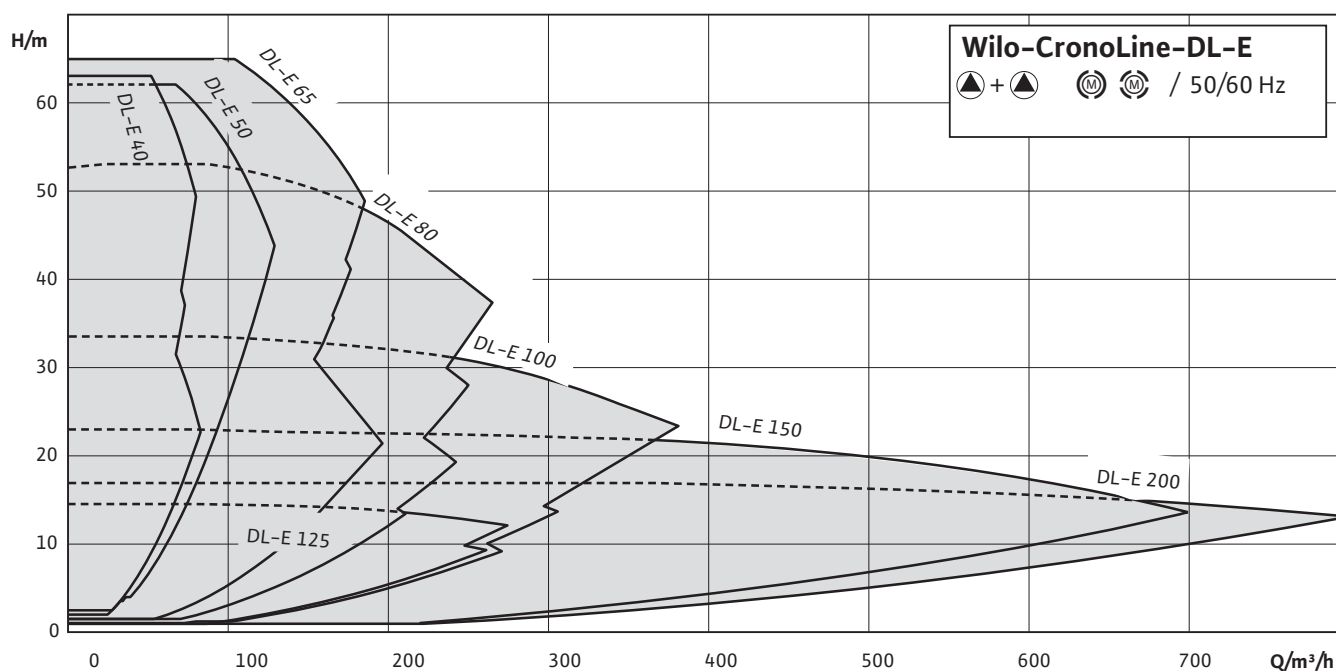

### Equipaggiamento/funzionamento

#### Modi di funzionamento

- $\Delta p$ -c per pressione differenziale costante
- $\Delta p$ -v per pressione differenziale variabile
- Controllo PID
- Funzionamento come servomotore (n = costante)

#### Livello di comando

- Pulsante rosso e display

#### Funzioni manuali

- Impostazione pompa on/off
- Impostazione del modo funzionamento
- Configurazione di tutti i parametri di esercizio
- Impostazione del numero di giri
- 

#### Funzioni di comando esterne

- Ingresso di comando "prioritario Off"
- Ingresso di comando "scambio pompa" (solo con funzionamento a pompa doppia)
- Ingresso analogico per funzionamento come servomotore (DDC) e regolazione a distanza del valore di consegna:
  - 0-10 V
  - 2-10 V
  - 0-20 mA
  - 4-20 mA
- Ingresso analogico per segnale diretto dal sensore di pressione:
  - 0-10 V
  - 2-10 V
  - 0-20 mA
  - 4-20 m

#### Funzioni di segnalazione e visualizzazione

- Segnalazione cumulativa di blocco SSM
- Segnalazione cumulativa di funzionamento SBM

#### Scambio dati

- Porta di comunicazione a infrarossi per lo scambio dati senza fili con monitor IR o WILO-IR STICK
- Vano per innesto di moduli IF Wilo (Modbus, BACnet, CAN, PLR, LON) per interfaccia al sistema di automazione degli edifici (BMS)
- 

#### Funzioni di sicurezza

- Protezione integrale del motore con elettronica di sgancio integrata
- Blocco accesso (regolazione)

#### Management pompa doppia (1 pompa gemellare)

- Funzionamento principale/di riserva scambio pompa dopo 24 ore di funzionamento (o eventuale anomalia ad una pompa)
- Funzione pompa doppia (somma di portata) punto di funzionamento ottimizzato al migliore rendimento

#### Opzioni

- Versione ...-R1 senza trasduttore di pressione differenziale
- Variante ...-S1/-S2 con tenuta meccanica speciale

#### Accessori

- 3 mensole con materiale di fissaggio per montaggio a basamento
- Monitor IR, WILO-IR STICK
- Modulo IF PLR per collegamento a PLR/convertitore porta di comunicazione
- Modulo IF LON per collegamento alla rete LONWORKS
- Modulo IF BACnet
- Modulo IF Modbus
- Modulo IF CAN
- Quadri elettrici di controllo VR-HVAC
- Quadri elettrici di controllo CCE-HVAC
- Quadri elettrici di controllo SCE-HVAC
- Trasduttore differenza di pressione (DDG)

Curve caratteristiche

CronoTwin-DL-E 100/220-5,5/4 (4 poli - funzionamento singolo)

Curve caratteristiche

CronoTwin-DL-E 100/220-5,5/4 (4 poli - funzionamento parallelo)

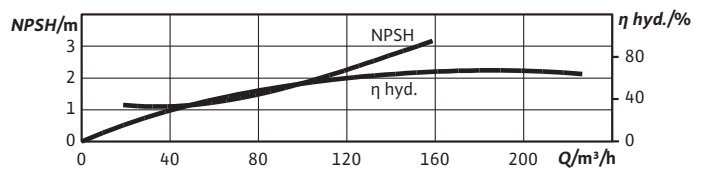
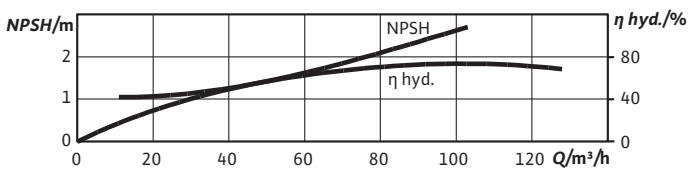
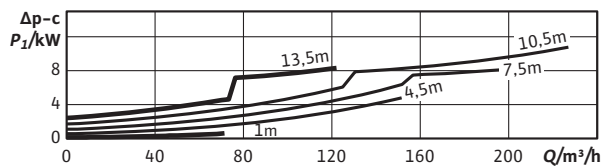
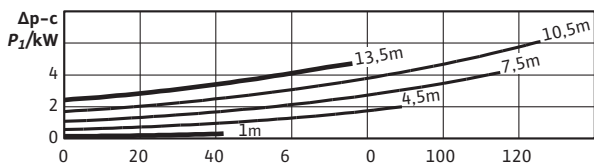
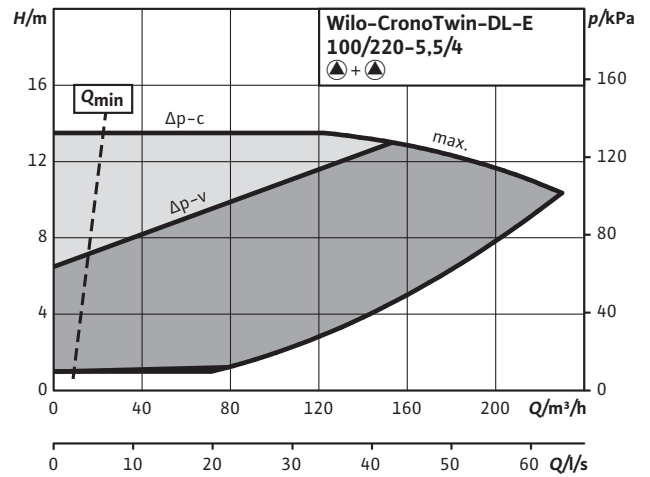
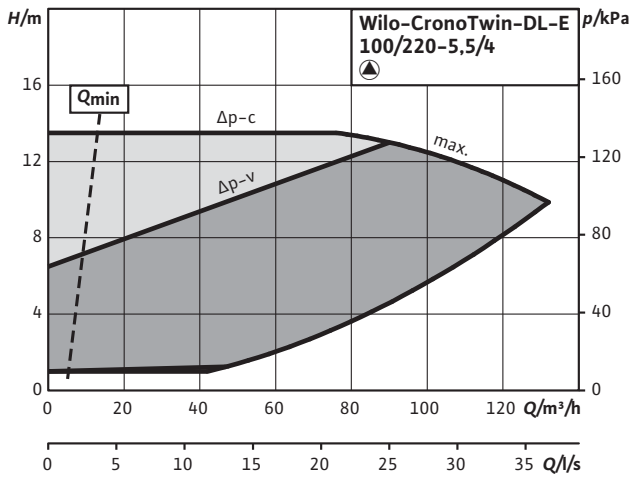
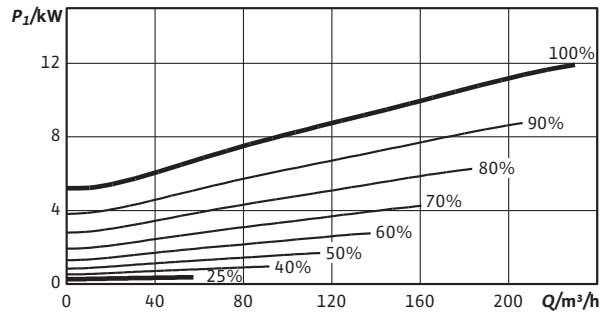
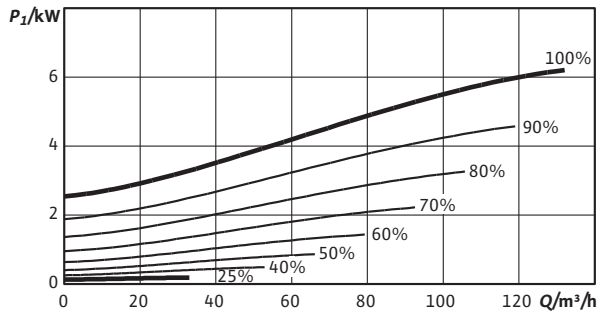
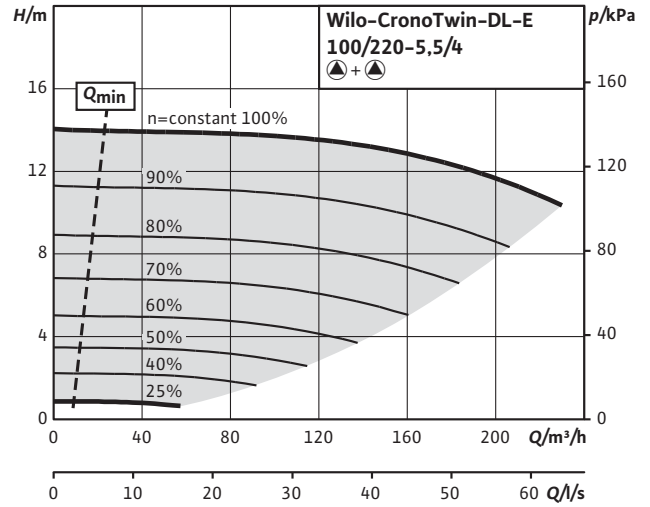
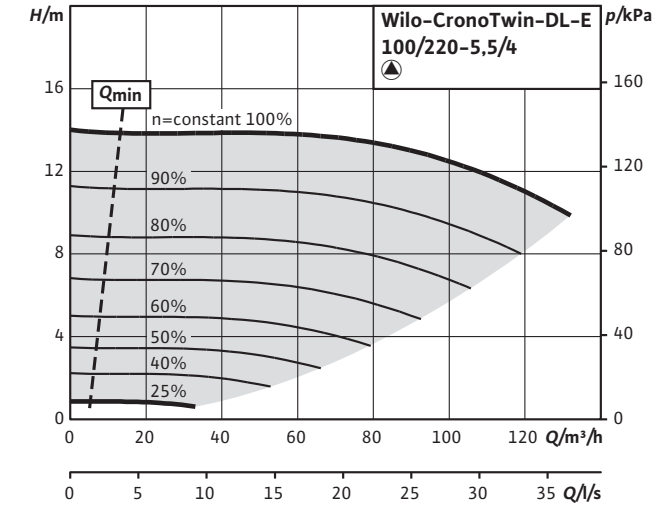



Curve caratteristiche

CronoTwin-DL-E 100/250-7,5/4 (4 poli - funzionamento singolo)

Curve caratteristiche

CronoTwin-DL-E 100/250-7,5/4 (4 poli - funzionamento parallelo)

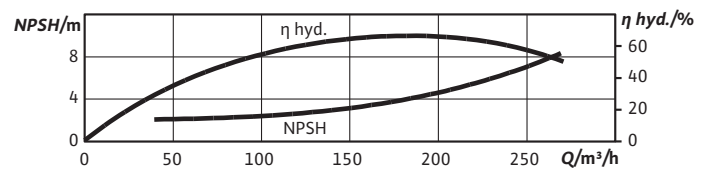
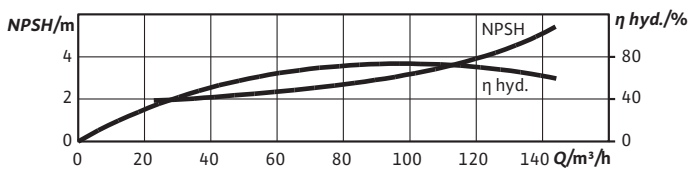
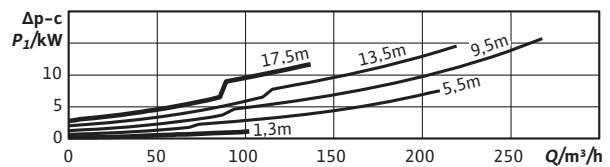
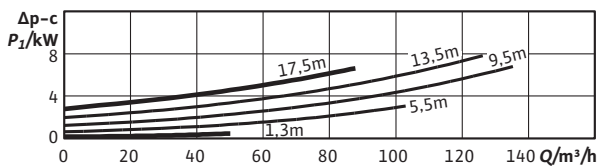
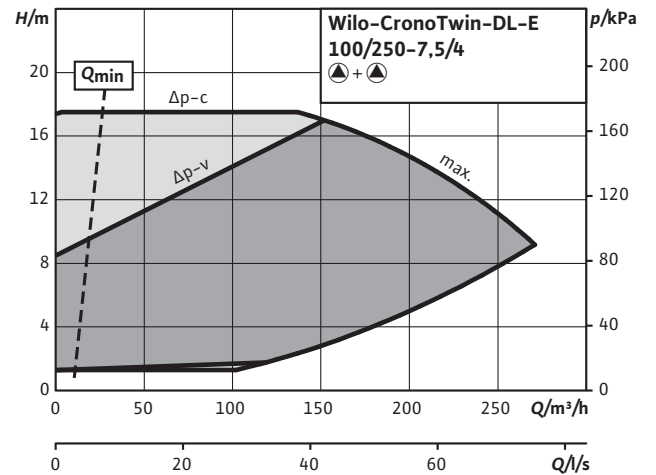
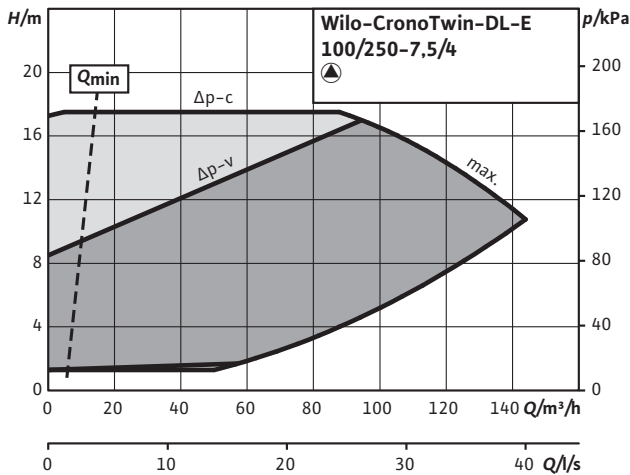
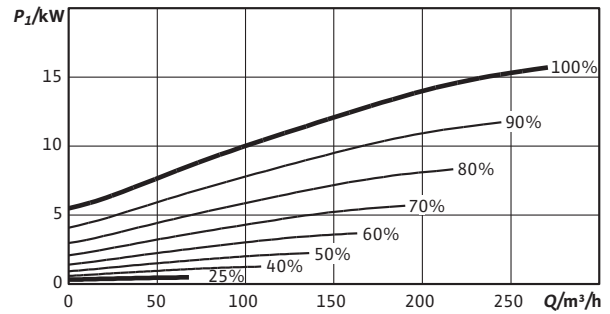
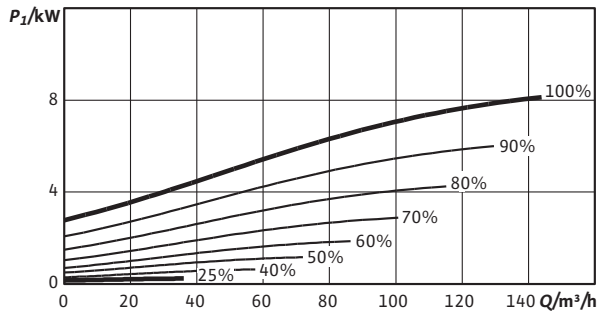
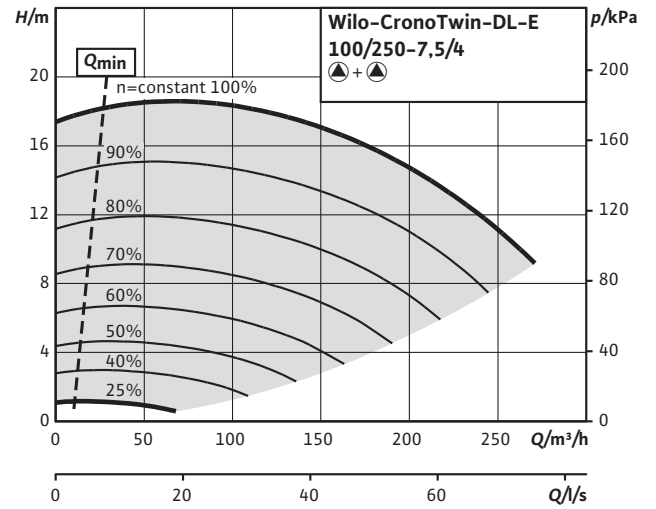
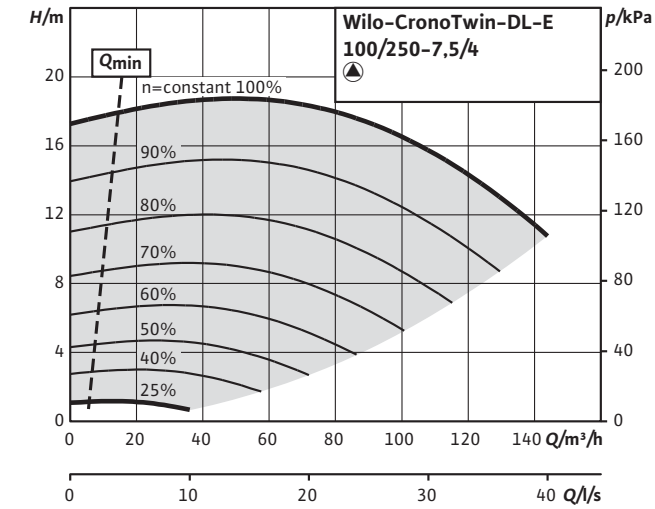

Riscaldamento, condizionamento e refrigerazione

Curve caratteristiche

CronoTwin-DL-E 100/270-11/4 (4 poli - funzionamento singolo)

Curve caratteristiche

CronoTwin-DL-E 100/270-11/4 (4 poli - funzionamento parallelo)

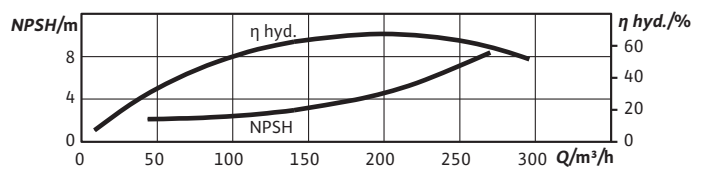
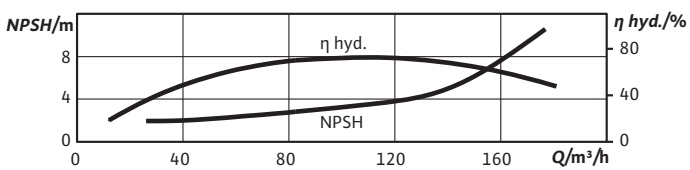
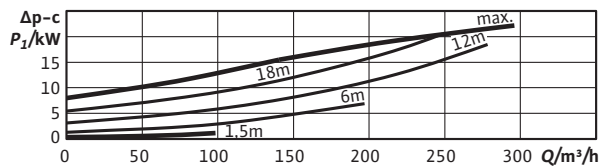
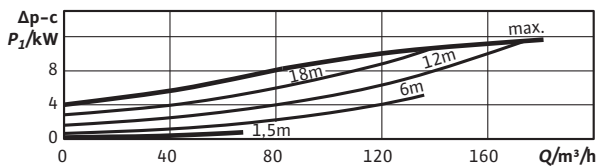
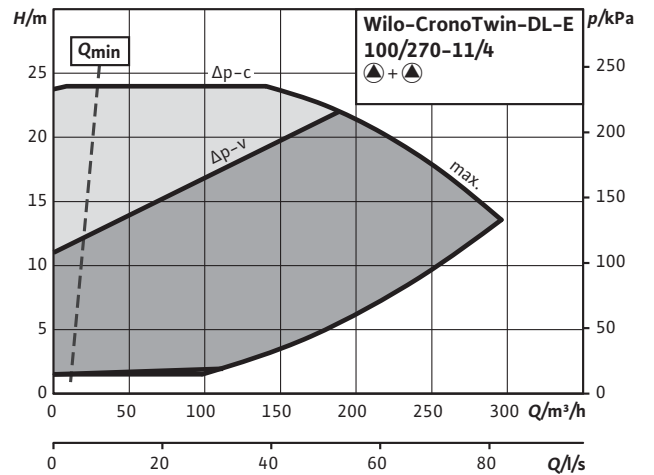
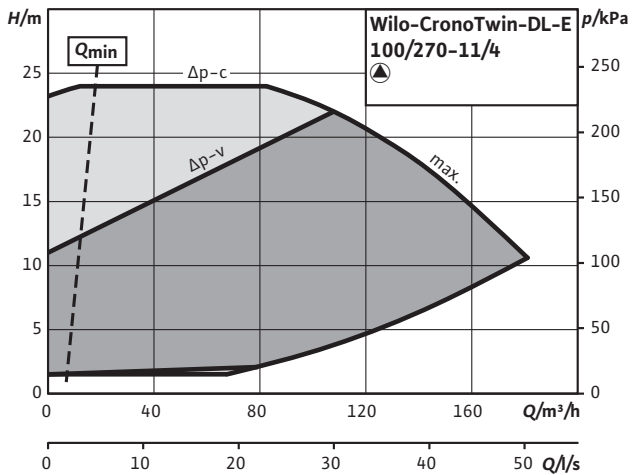
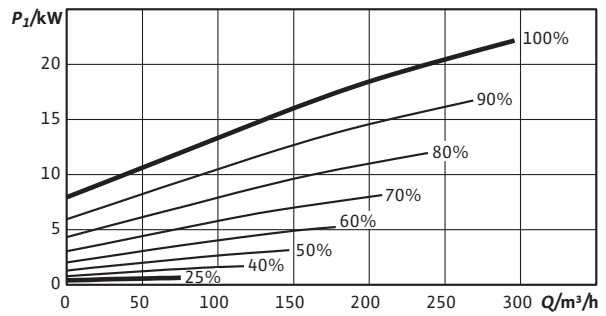
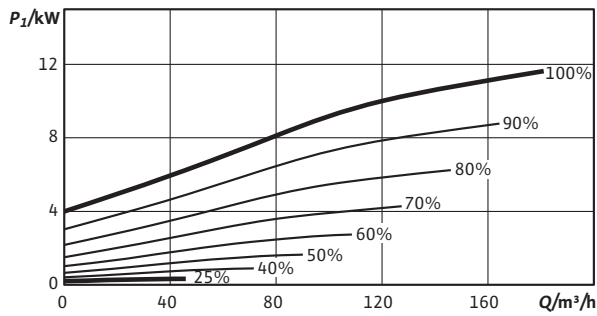
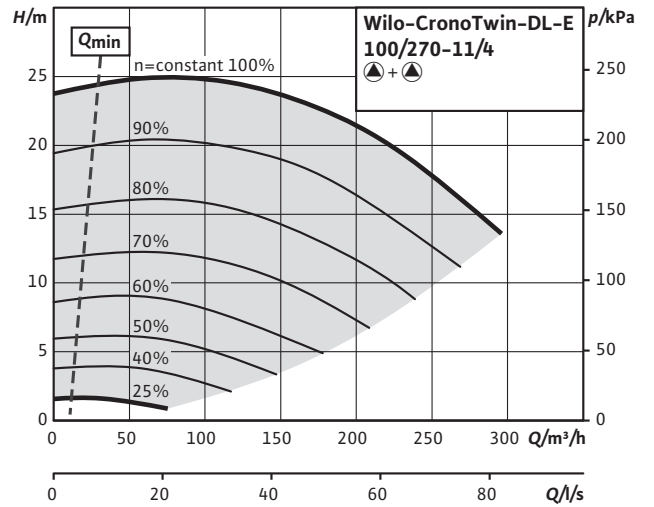
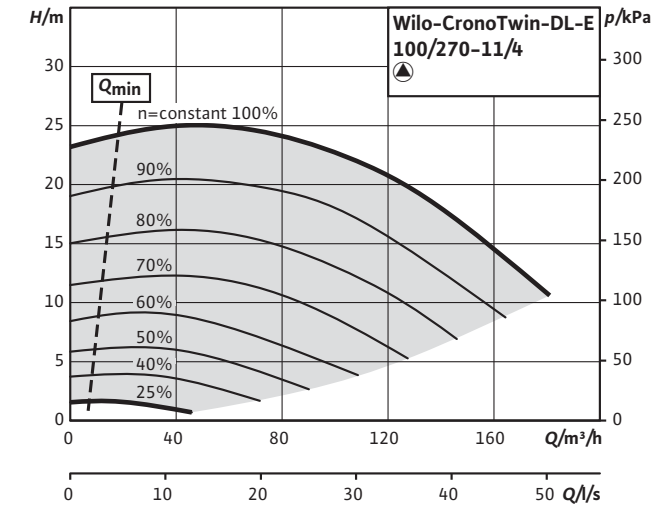

Curve caratteristiche

CronoTwin-DL-E 125/210-5,5/4 (4 poli - funzionamento singolo)

Curve caratteristiche

CronoTwin-DL-E 125/210-5,5/4 (4 poli - funzionamento parallelo)

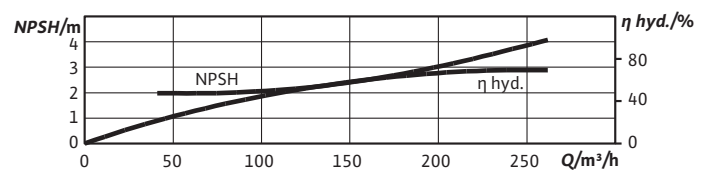
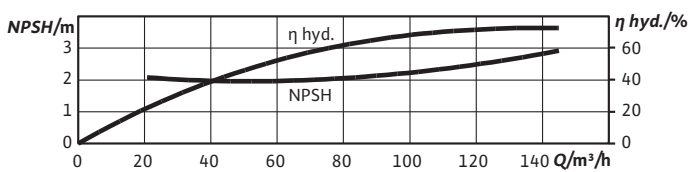
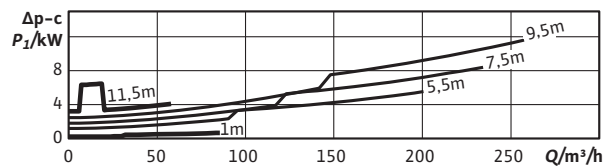
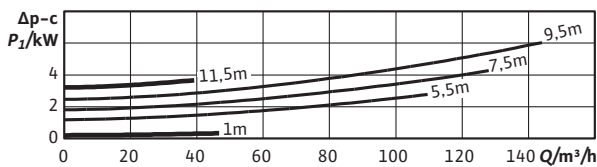
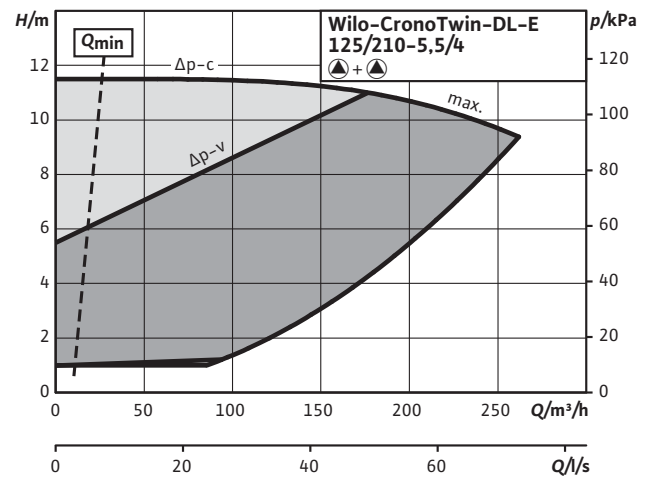
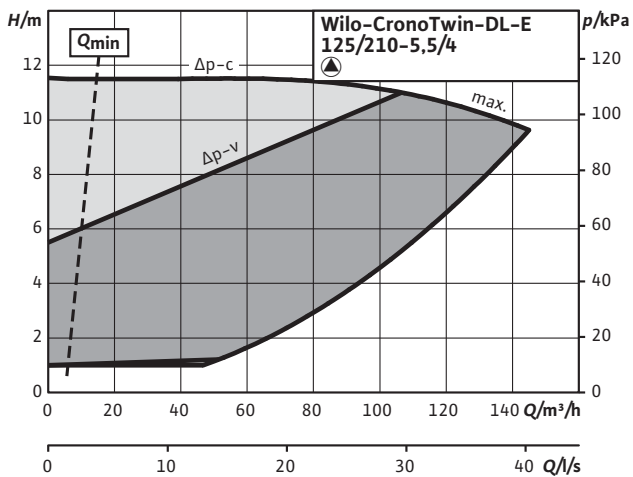
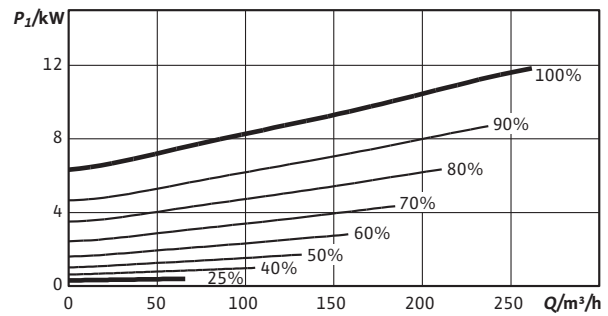
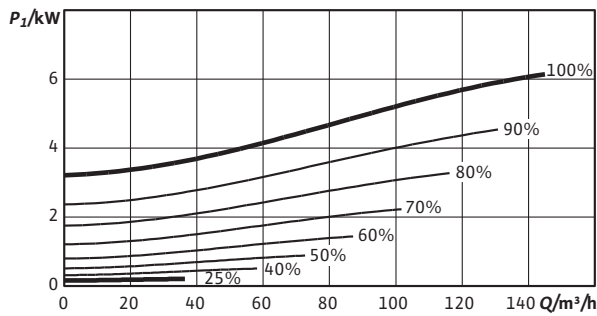
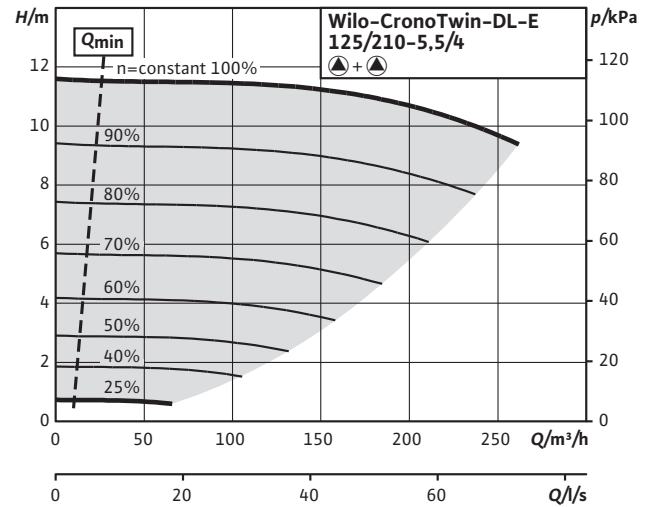
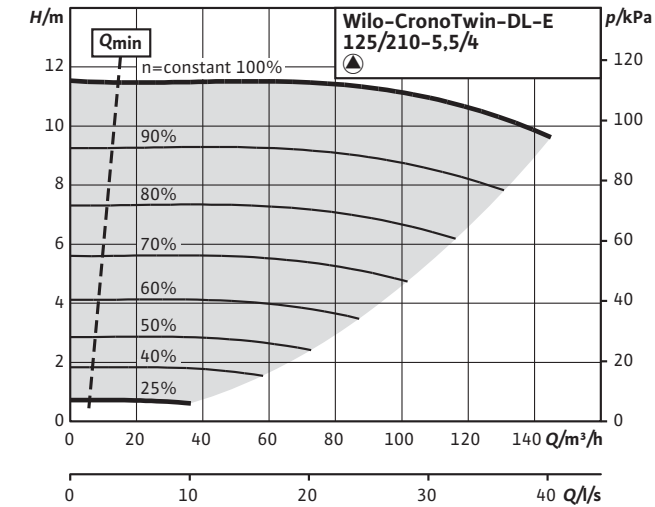

Riscaldamento, condizionamento e refrigerazione

Curve caratteristiche

CronoTwin-DL-E 125/220-7,5/4 (4 poli - funzionamento singolo)

Curve caratteristiche

CronoTwin-DL-E 125/220-7,5/4 (4 poli - funzionamento parallelo)

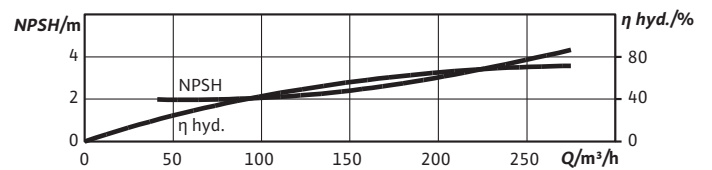
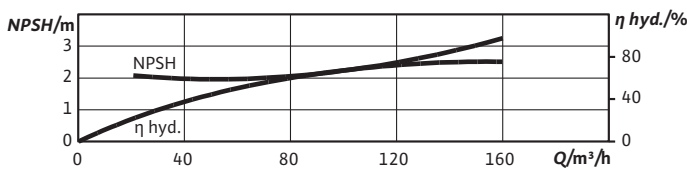
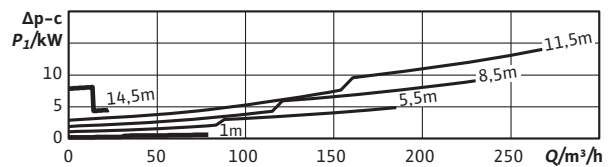
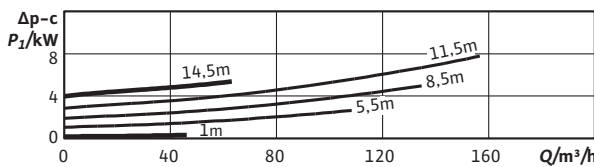
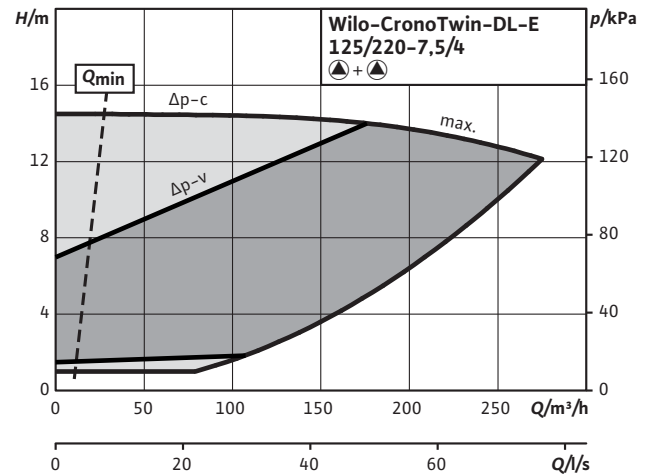
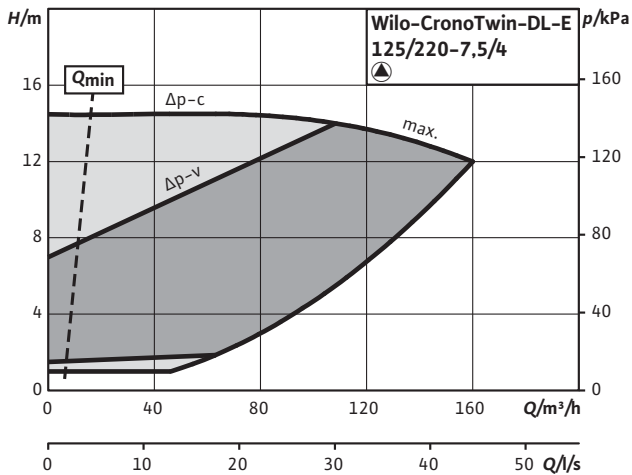
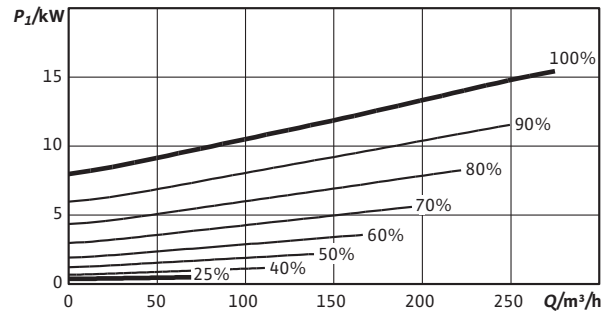
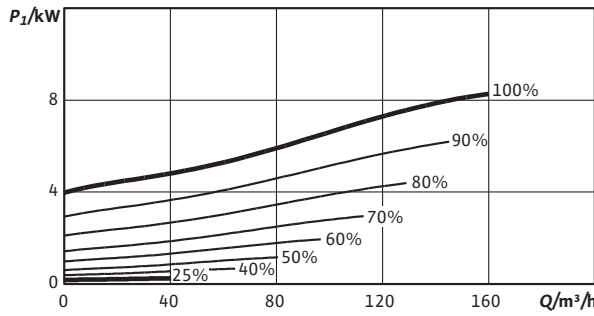
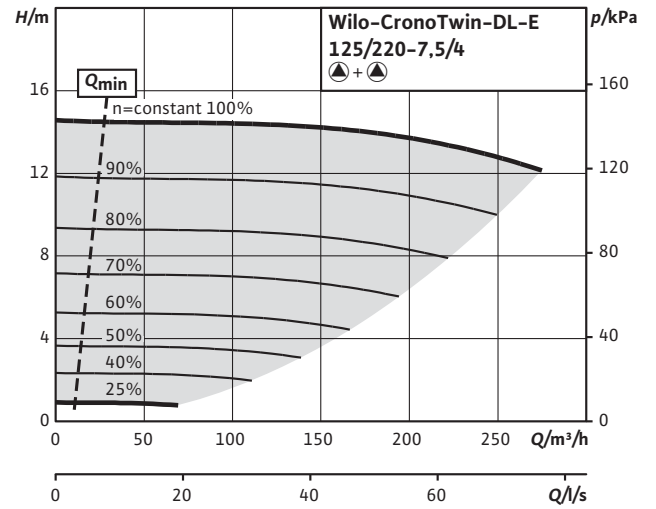
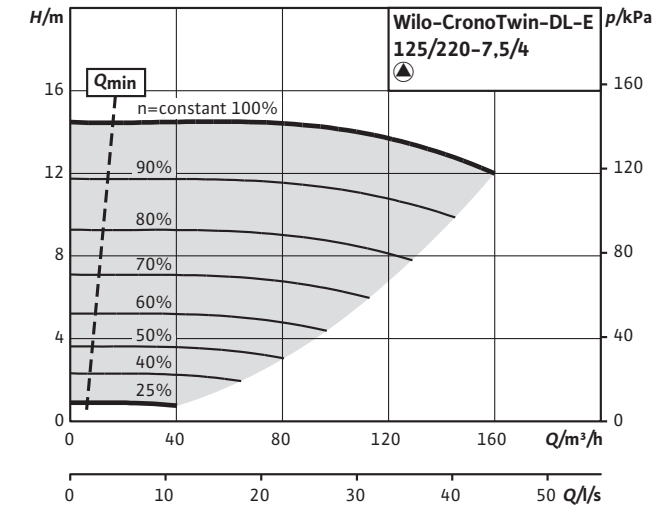

Curve caratteristiche

CronoTwin-DL-E 150/190-5,5/4 (4 poli - funzionamento singolo)

Curve caratteristiche

CronoTwin-DL-E 150/190-5,5/4 (4 poli - funzionamento parallelo)

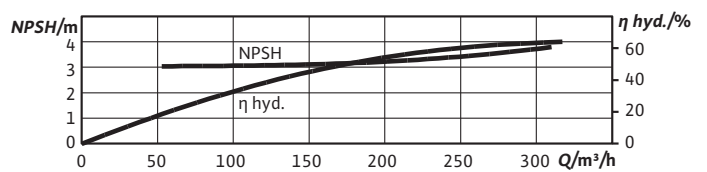
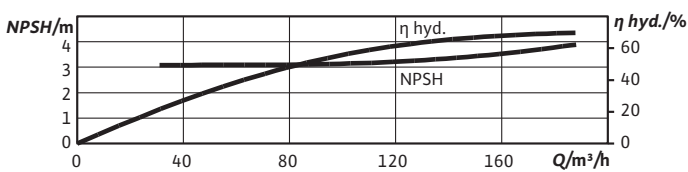
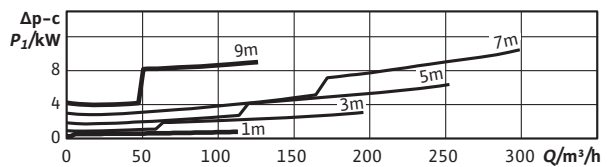
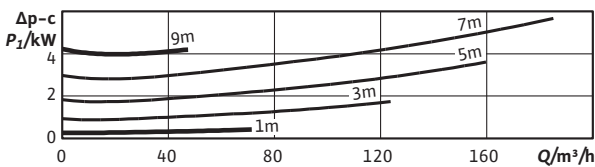
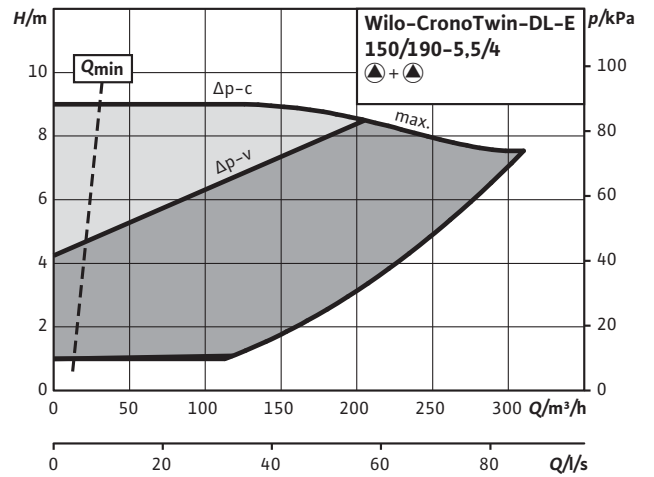
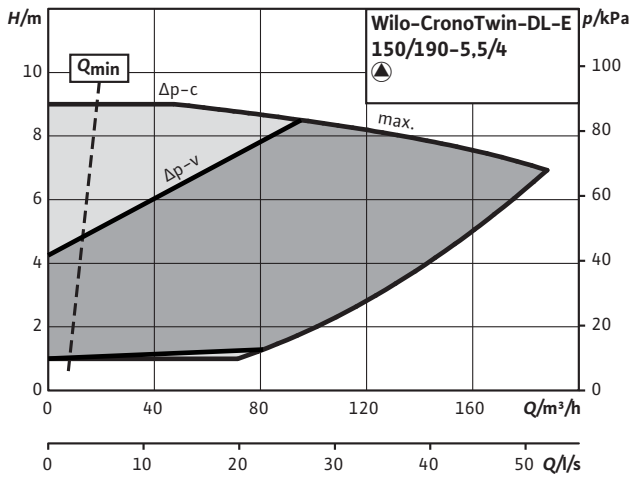
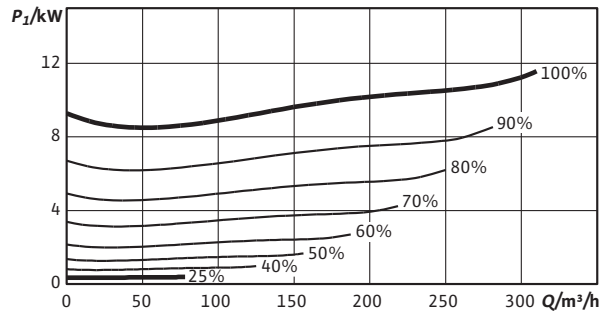
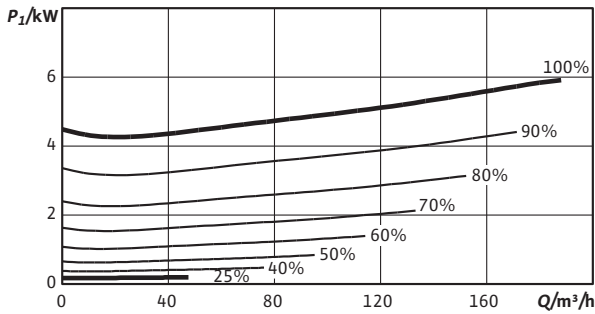
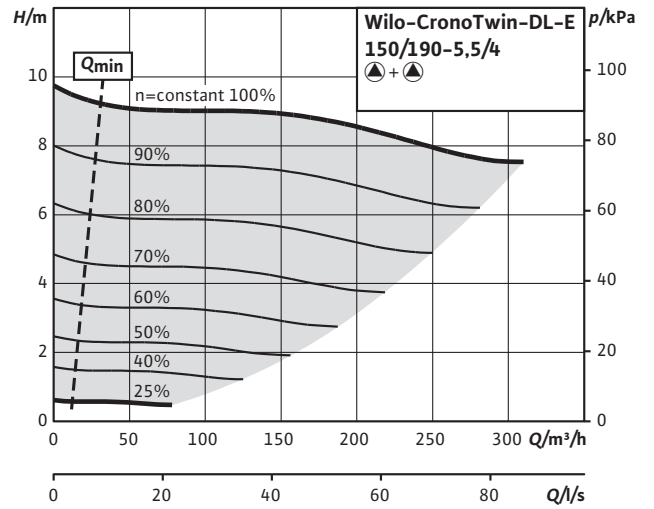
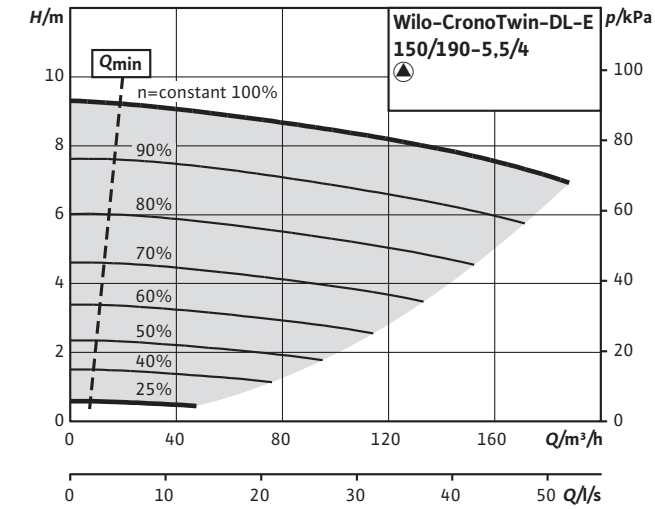

Riscaldamento, condizionamento e refrigerazione

Curve caratteristiche

CronoTwin-DL-E 150/200-7,5/4 (4 poli - funzionamento singolo)

Curve caratteristiche

CronoTwin-DL-E 150/200-7,5/4 (4 poli - funzionamento parallelo)

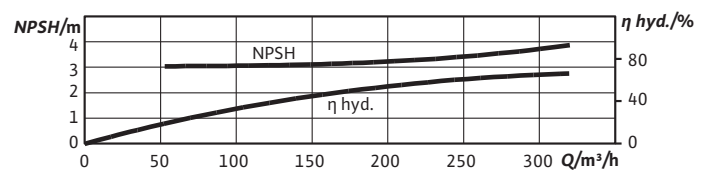
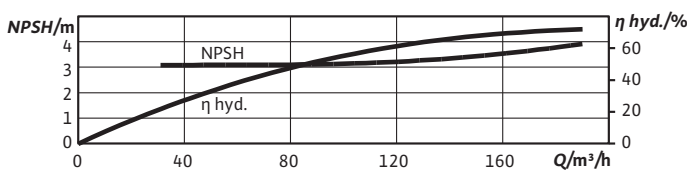
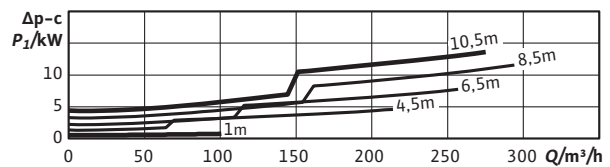
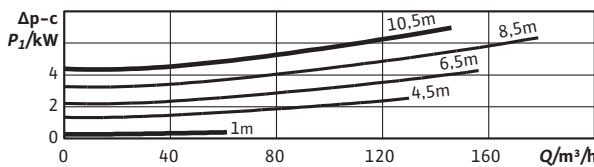
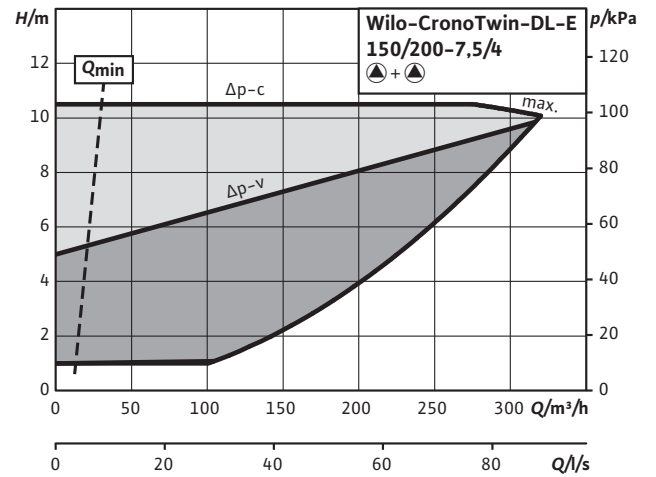
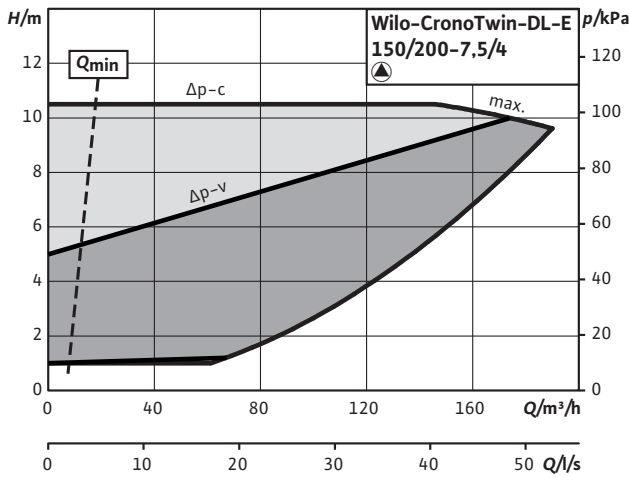
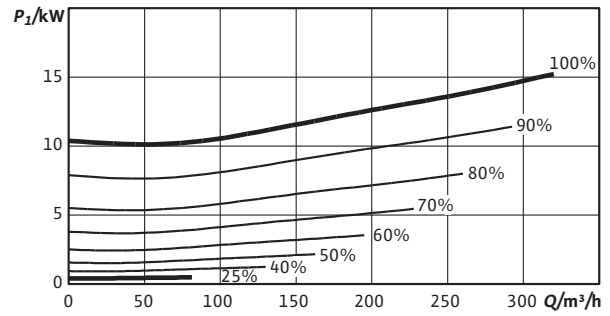
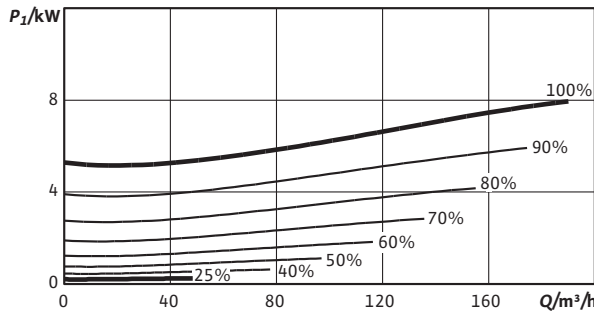
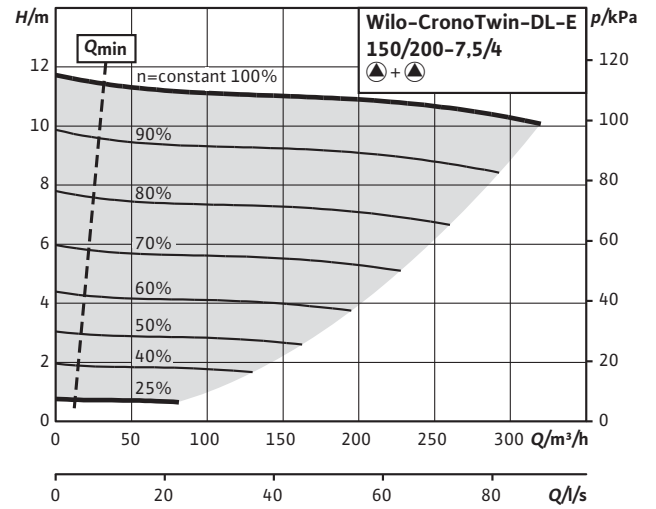
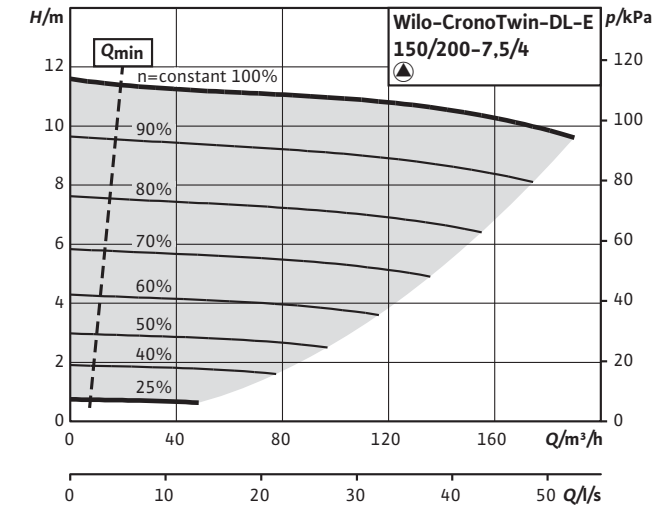

Curve caratteristiche

CronoTwin-DL-E 150/220-11/4 (4 poli - funzionamento singolo)

Curve caratteristiche

CronoTwin-DL-E 150/220-11/4 (4 poli - funzionamento parallelo)

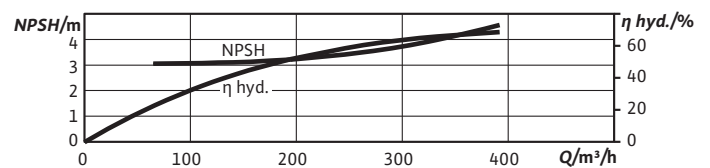
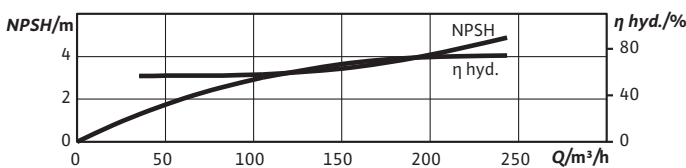
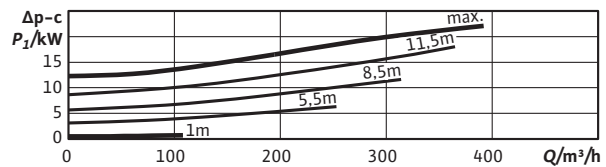
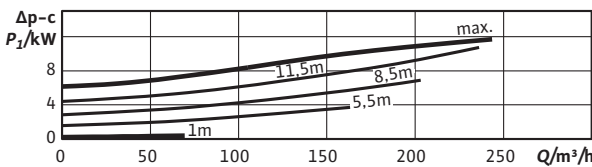
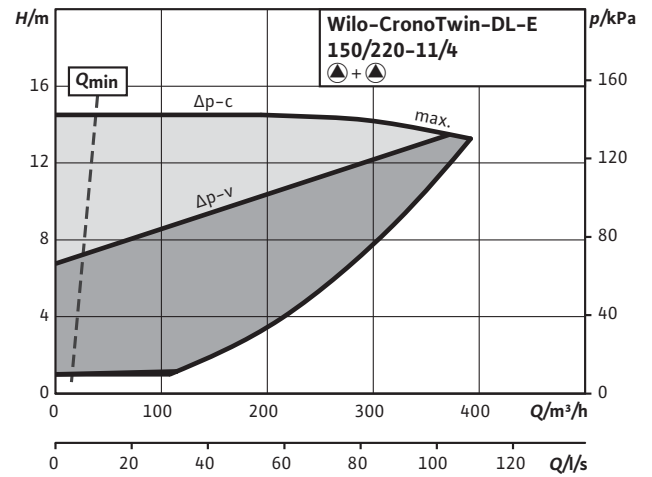
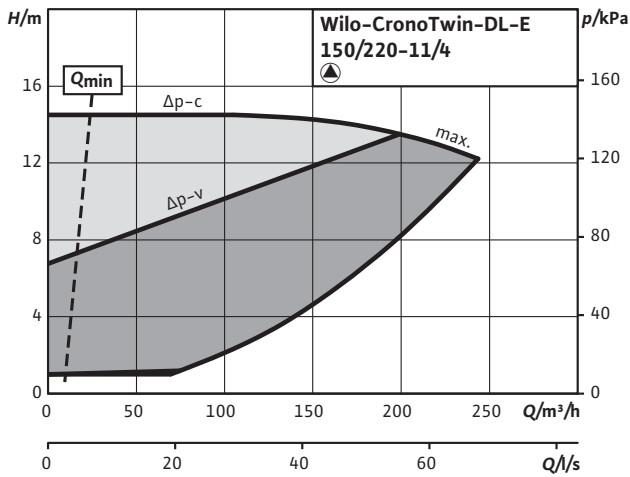
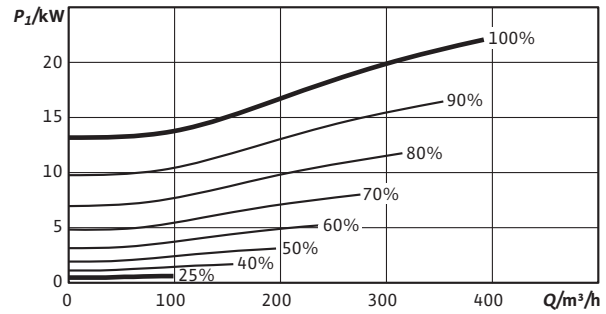
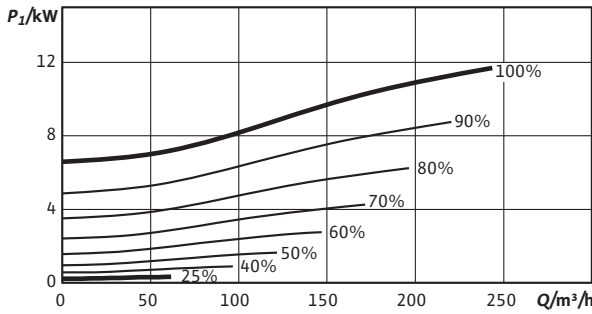
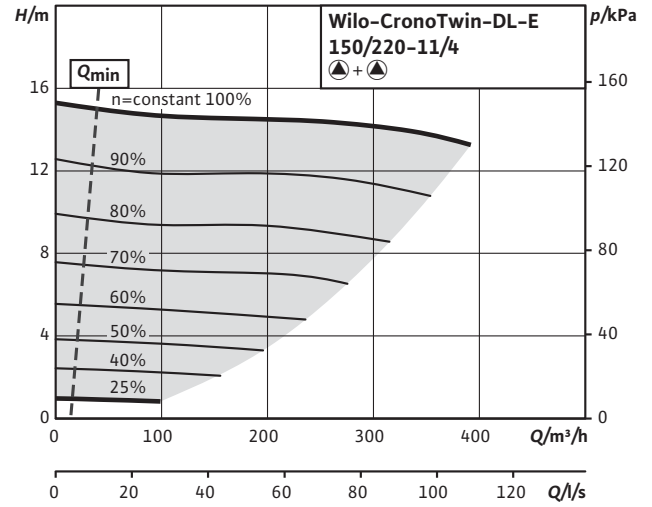
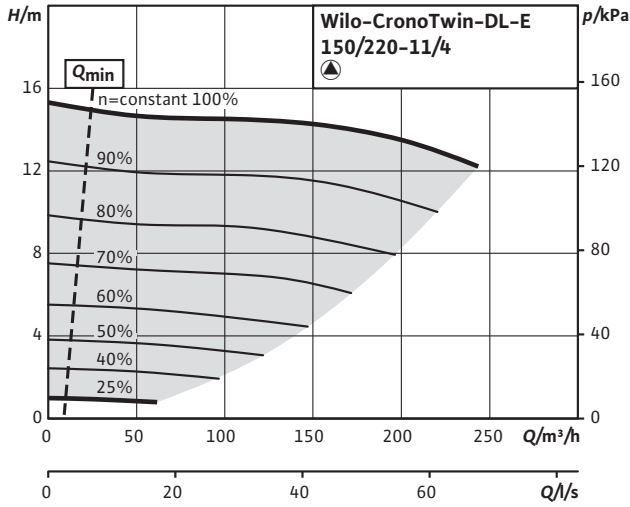

Riscaldamento, condizionamento e refrigerazione

Curve caratteristiche

CronoTwin-DL-E 150/250-15/4 (4 poli - funzionamento singolo)

Curve caratteristiche

CronoTwin-DL-E 150/250-15/4 (4 poli - funzionamento parallelo)

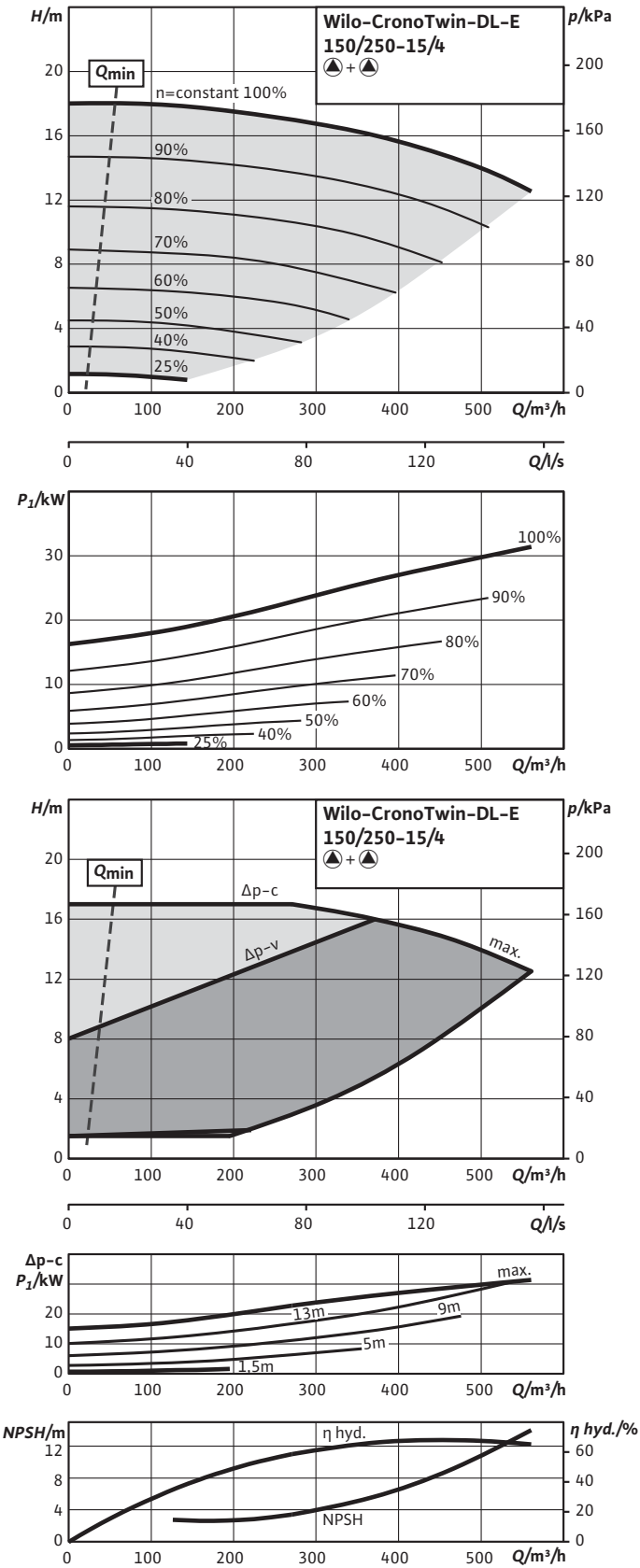
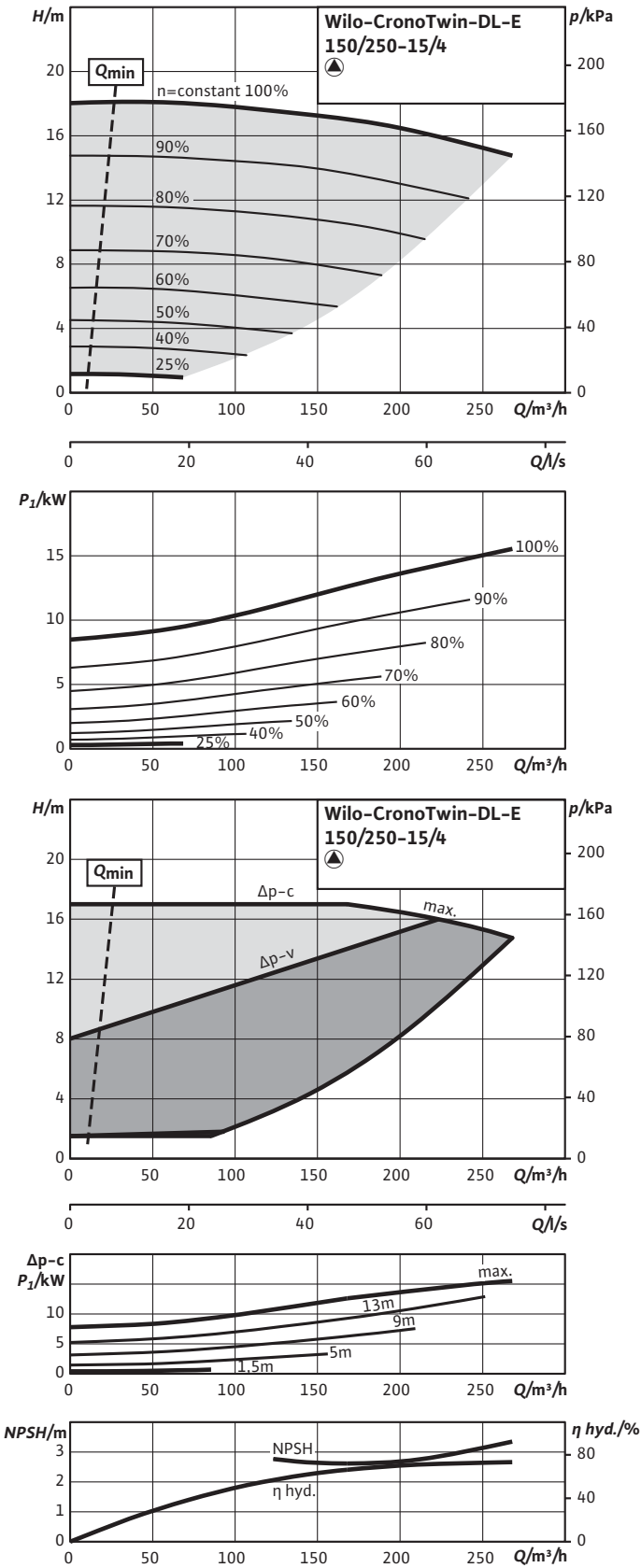



Curve caratteristiche

CronoTwin-DL-E 150/260-18,5/4 (4 poli - funzionamento singolo)

Curve caratteristiche

CronoTwin-DL-E 150/260-18,5/4 (4 poli - funzionamento parallelo)

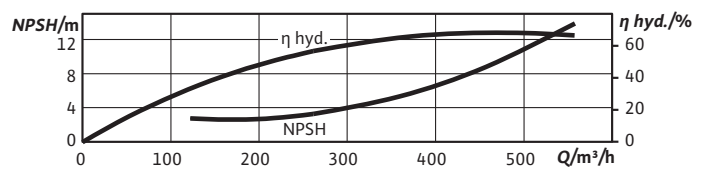
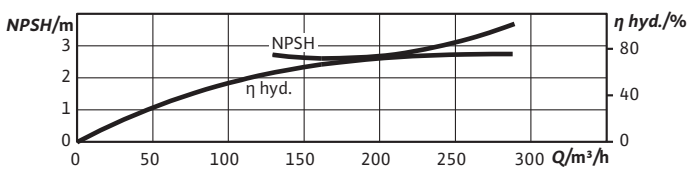
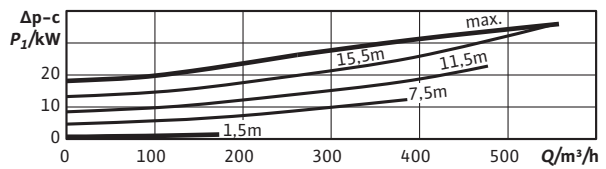
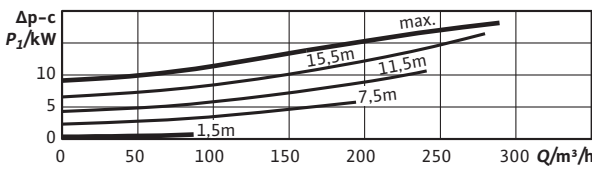
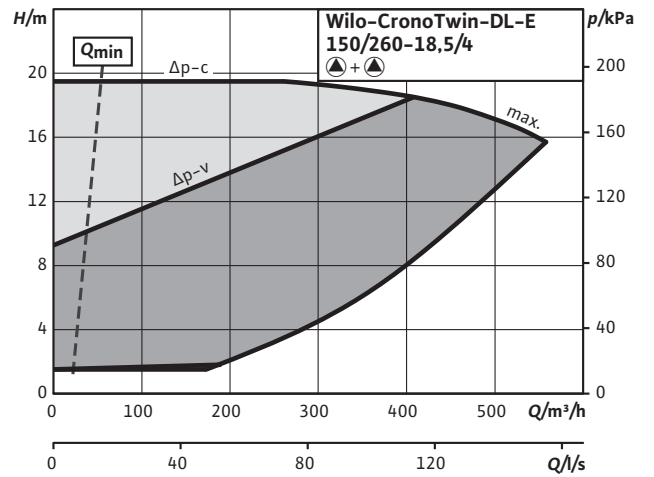
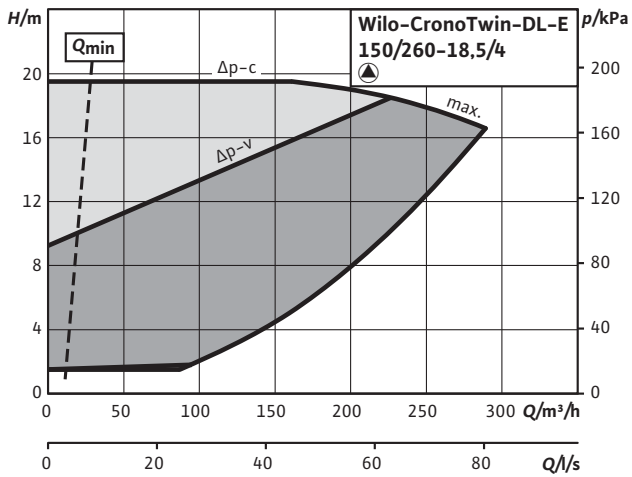
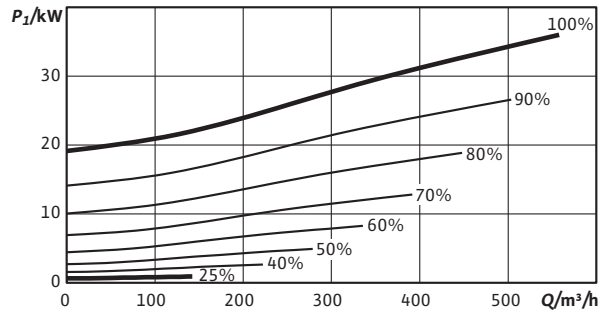
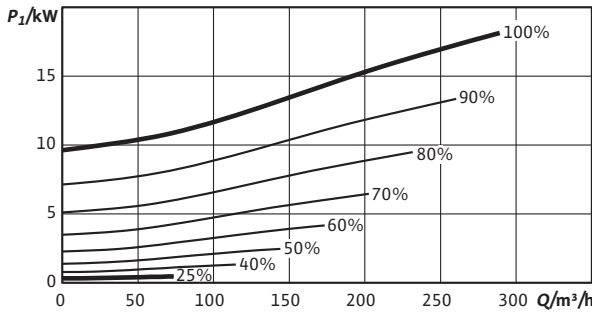
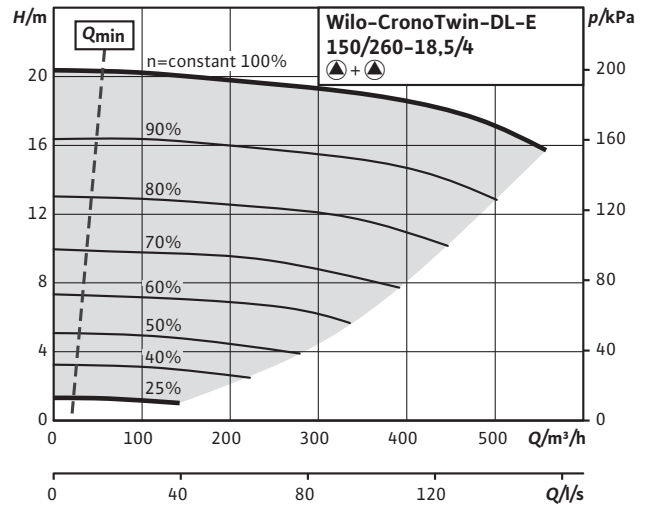
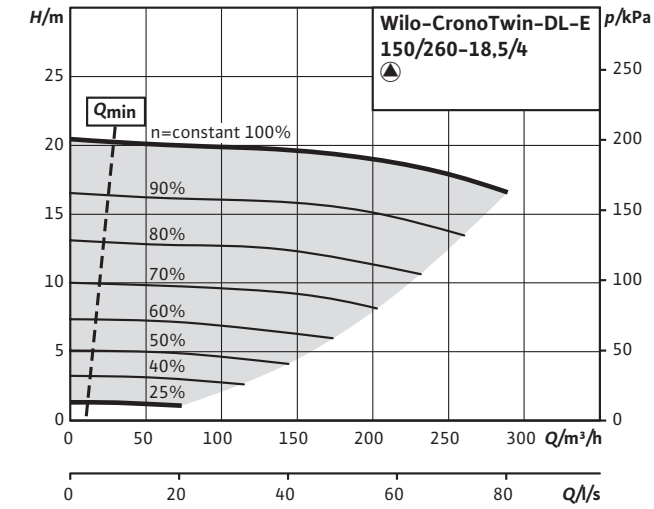

Riscaldamento, condizionamento e refrigerazione

Curve caratteristiche

CronoTwin-DL-E 150/270-22/4 (4 poli - funzionamento singolo)

Curve caratteristiche

CronoTwin-DL-E 150/270-22/4 (4 poli - funzionamento parallelo)

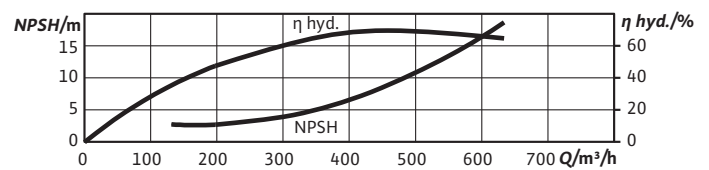
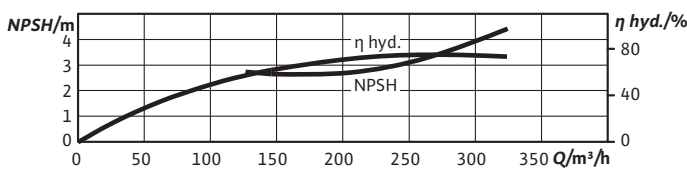
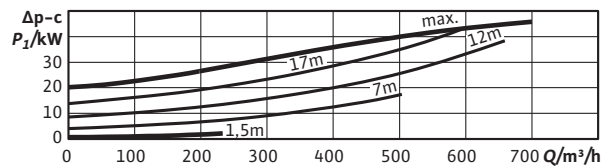
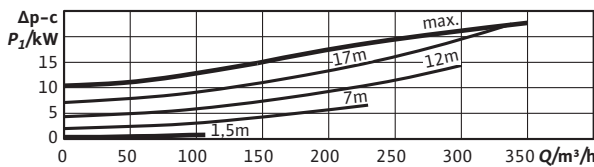
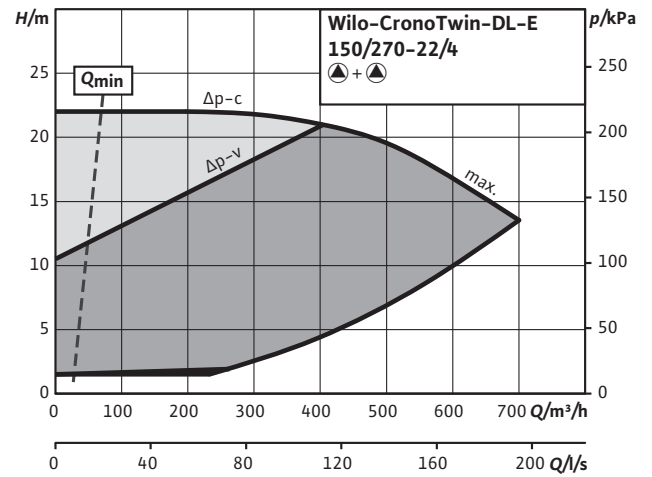
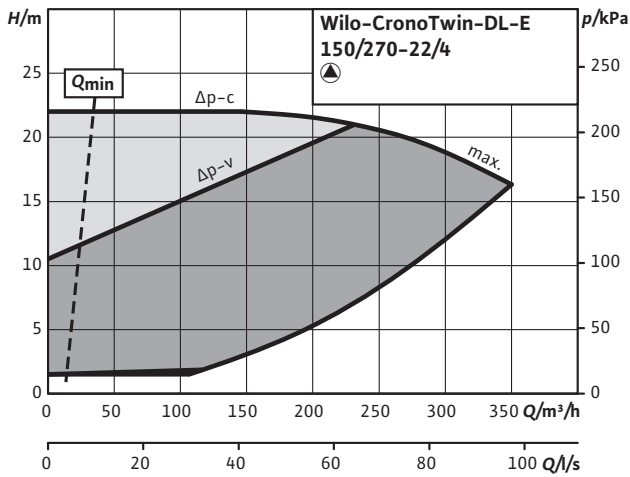
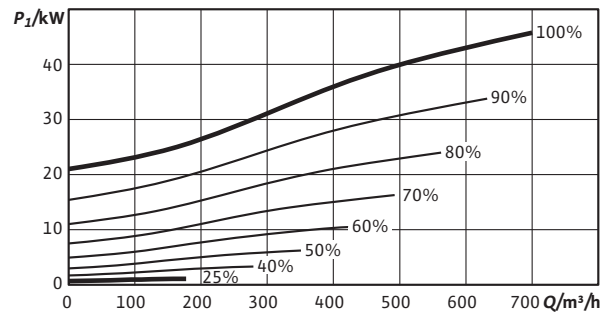
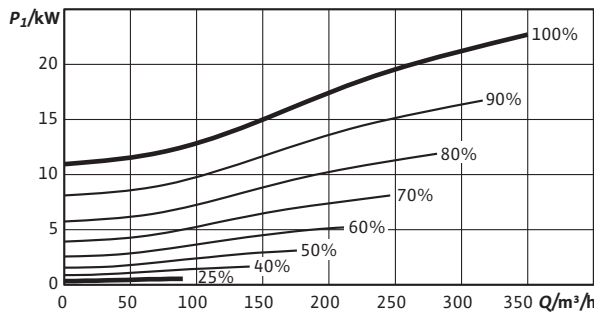
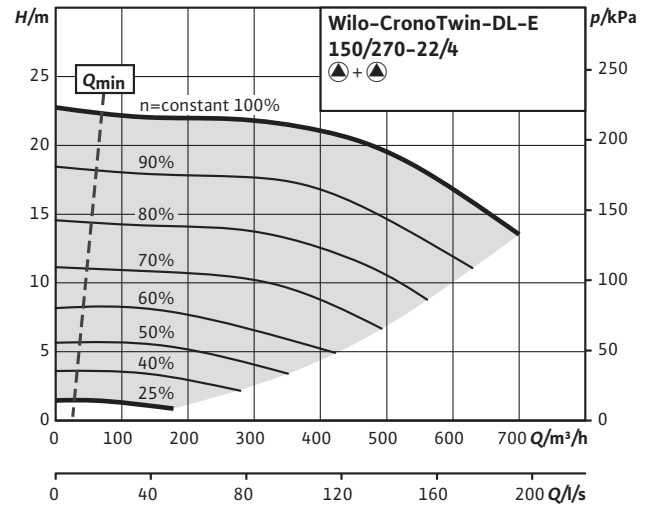
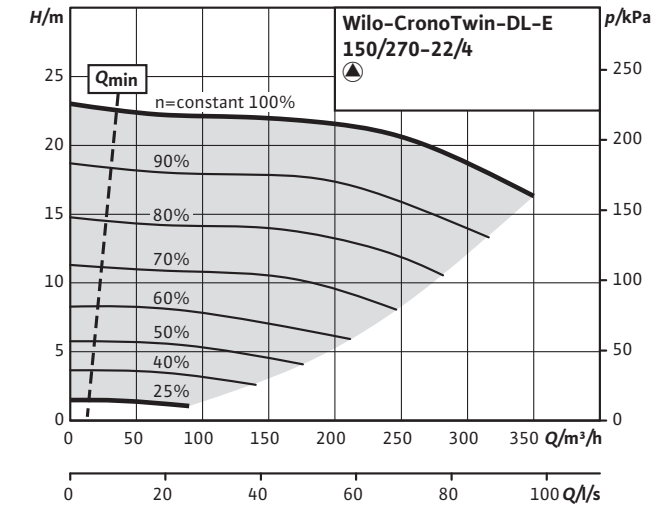

Curve caratteristiche

CronoTwin-DL-E 200/240-15/4 (4 poli - funzionamento singolo)

Curve caratteristiche

CronoTwin-DL-E 200/240-15/4 (4 poli - funzionamento parallelo)

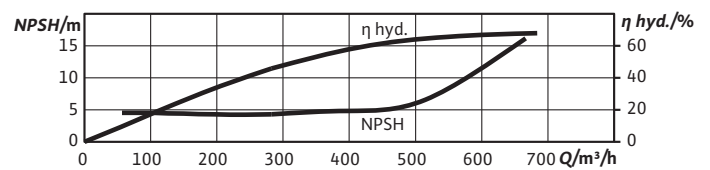
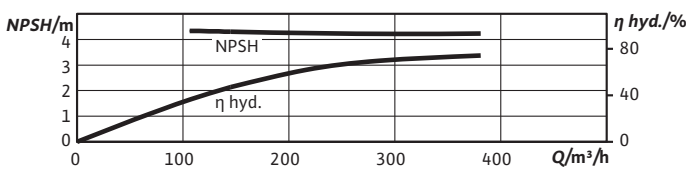
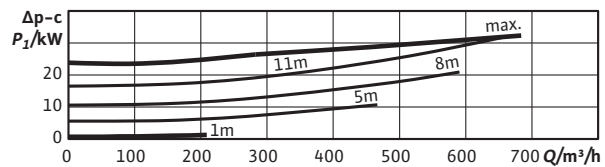
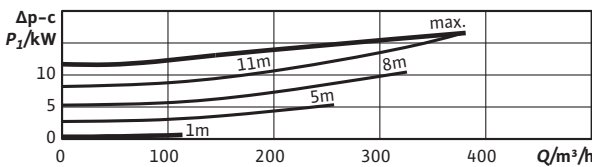
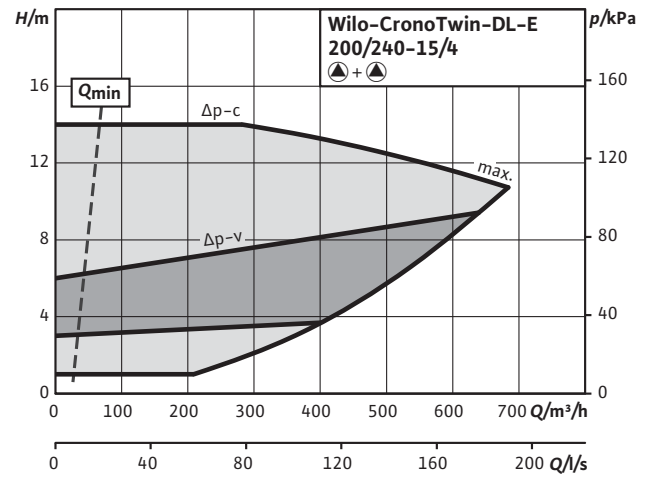
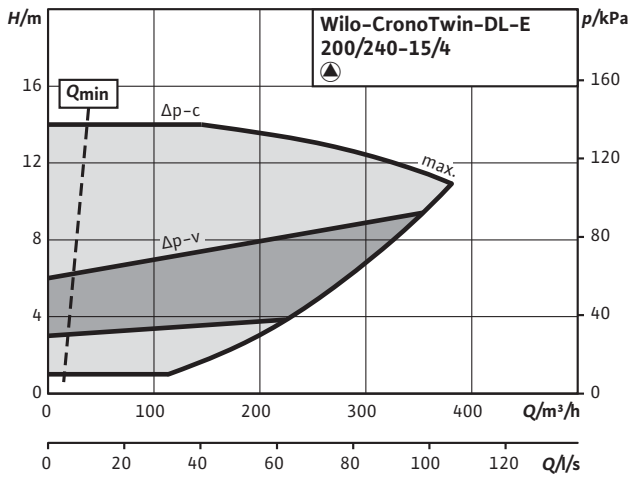
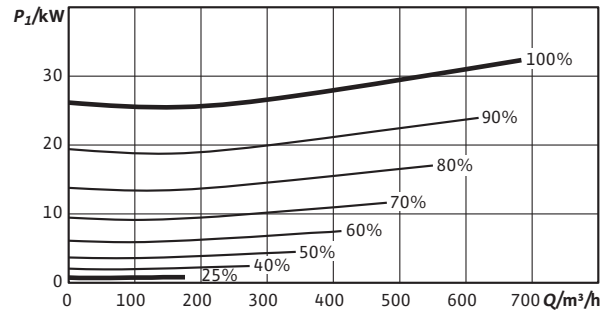
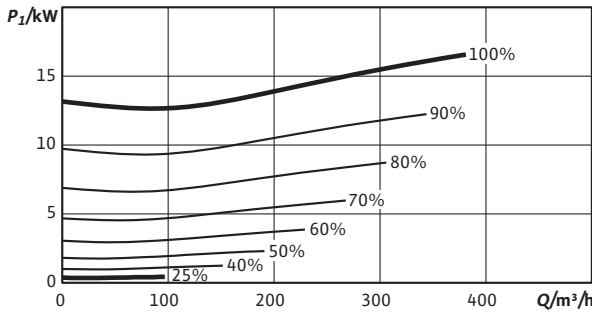
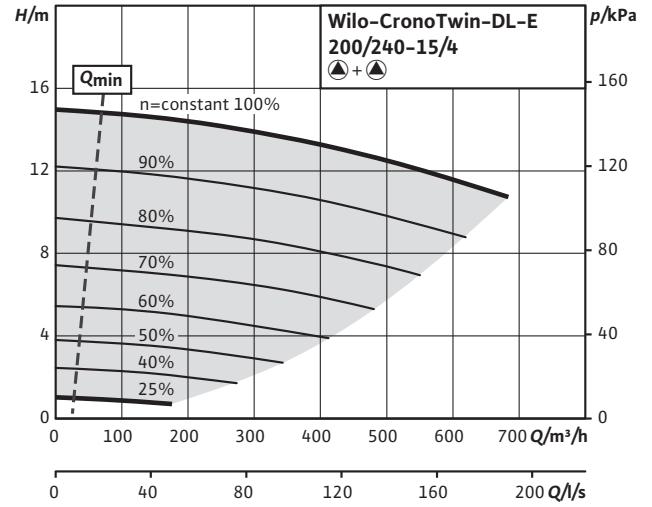
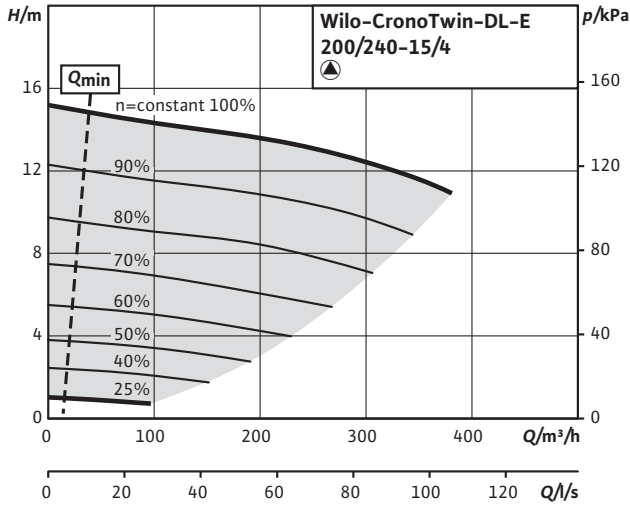

Riscaldamento, condizionamento e refrigerazione

Curve caratteristiche

CronoTwin-DL-E 200/250-18,5/4 (4 poli - funzionamento singolo)

Curve caratteristiche

CronoTwin-DL-E 200/250-18,5/4 (4 poli - funzionamento parallelo)

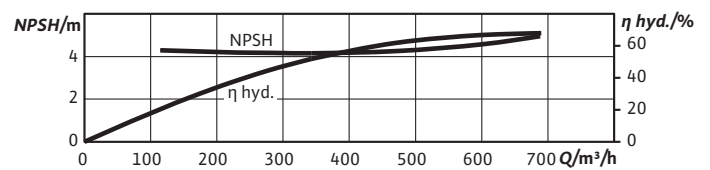
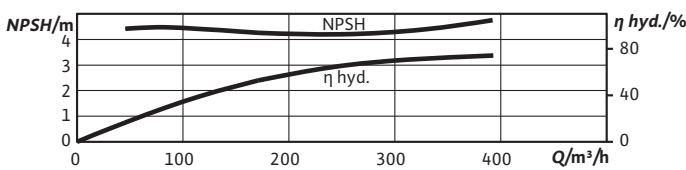
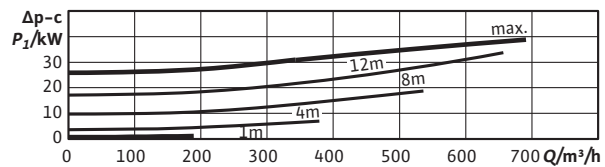
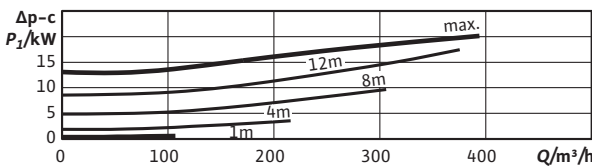
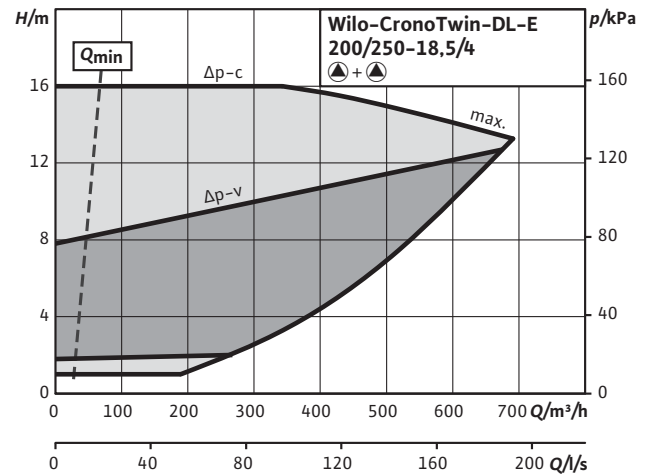
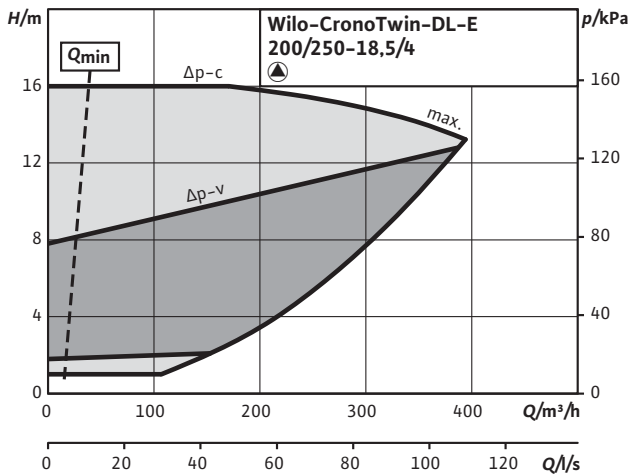
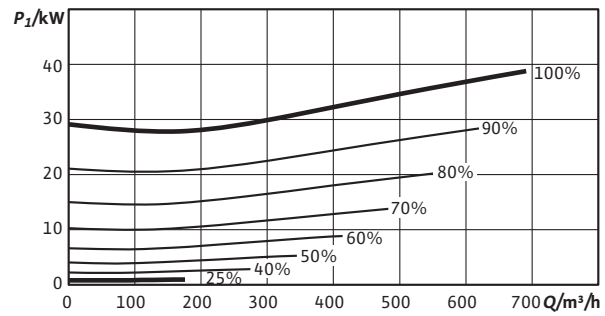
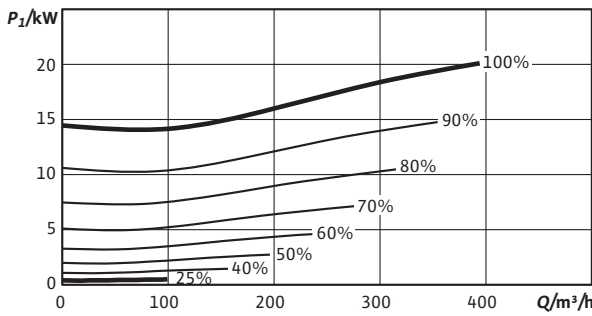
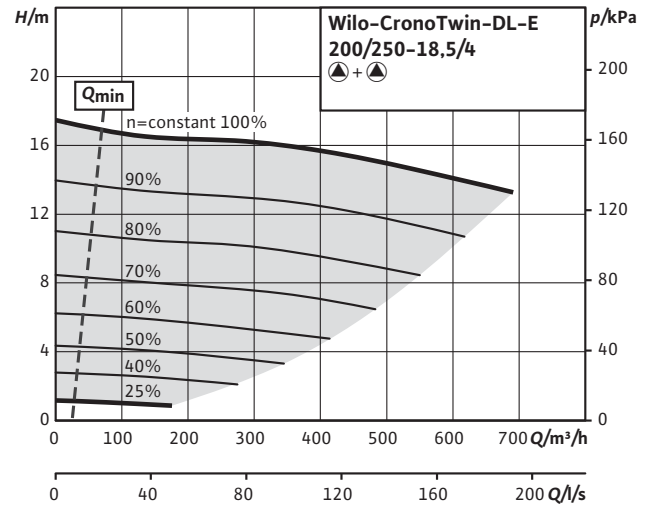
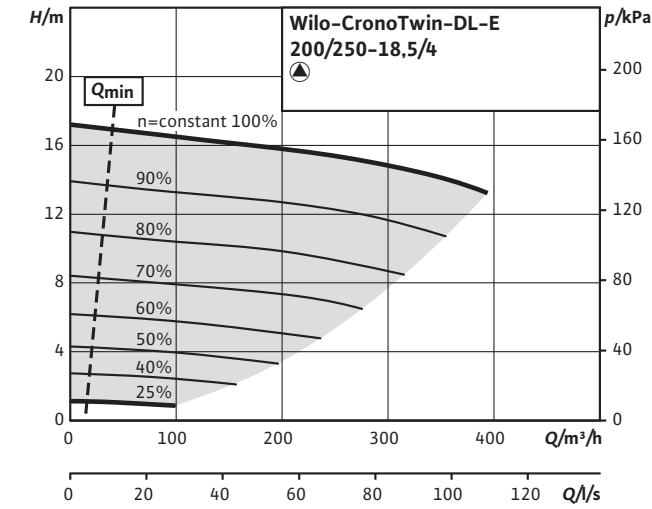

Curve caratteristiche

CronoTwin-DL-E 200/260-22/4 (4 poli - funzionamento singolo)

Curve caratteristiche

CronoTwin-DL-E 200/260-22/4 (4 poli - funzionamento parallelo)

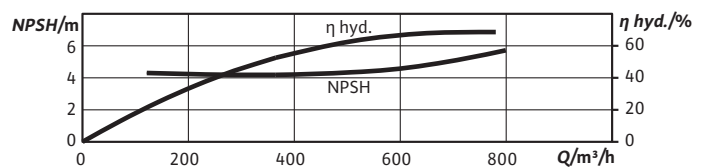
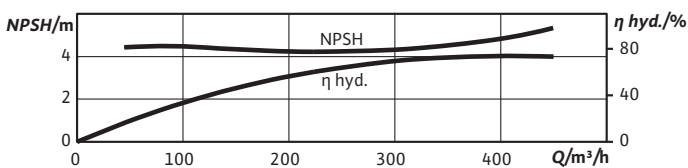
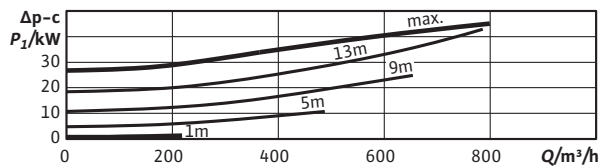
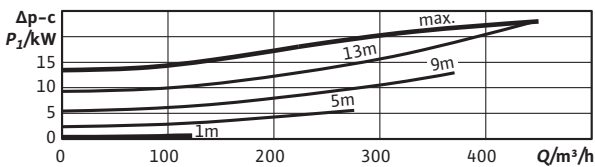
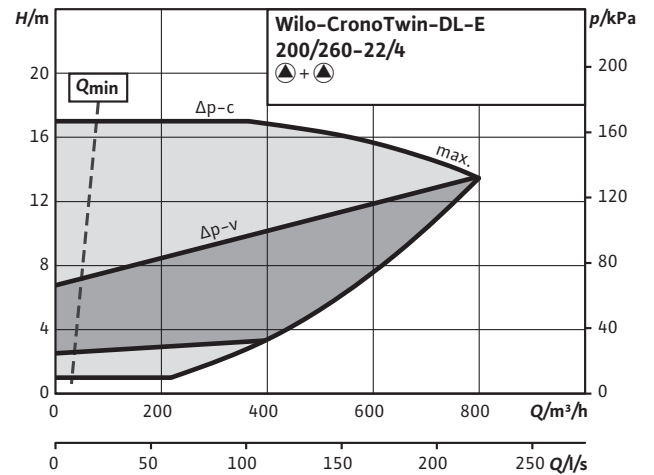
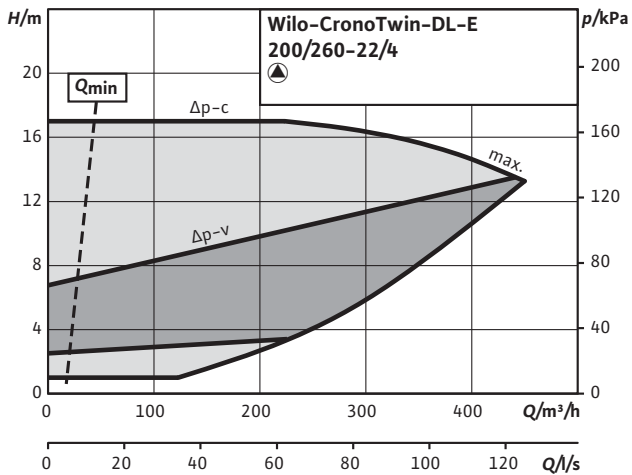
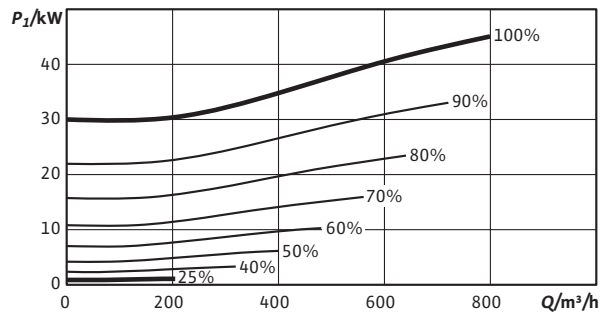
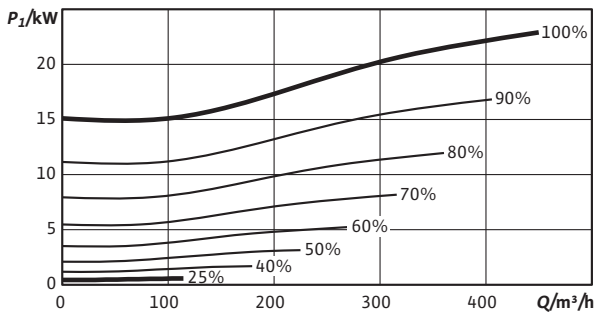
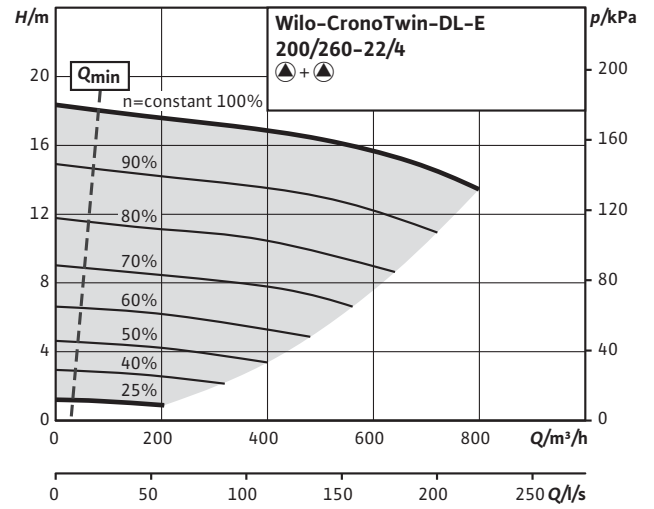
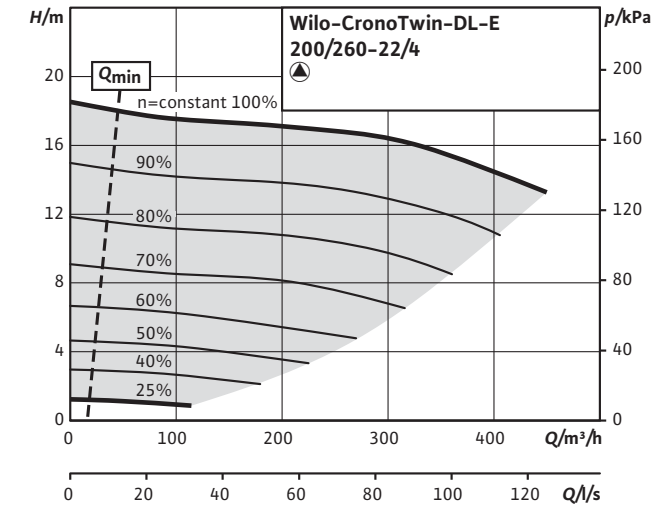

Riscaldamento, condizionamento e refrigerazione

Curve caratteristiche

CronoTwin-DL-E 40/170-5,5/2 (2 poli - funzionamento singolo)

Curve caratteristiche

CronoTwin-DL-E 40/170-5,5/2 (2 poli - funzionamento parallelo)

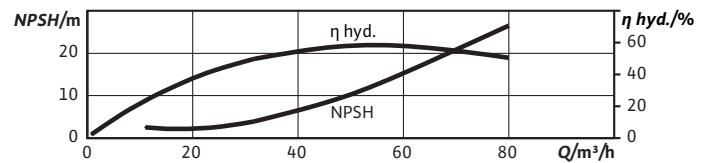
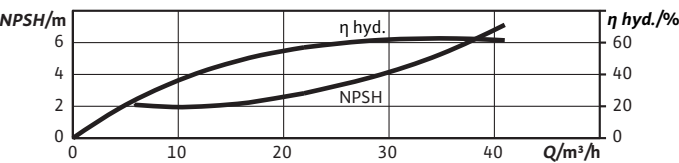
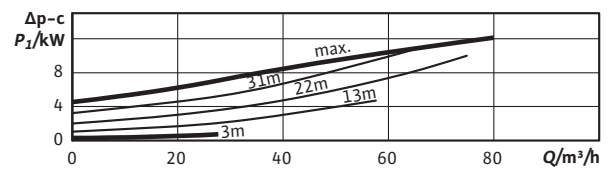
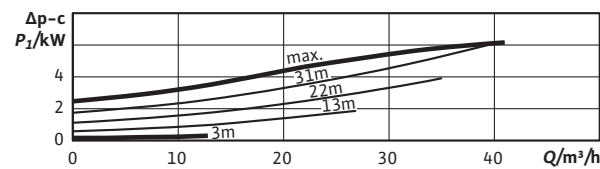
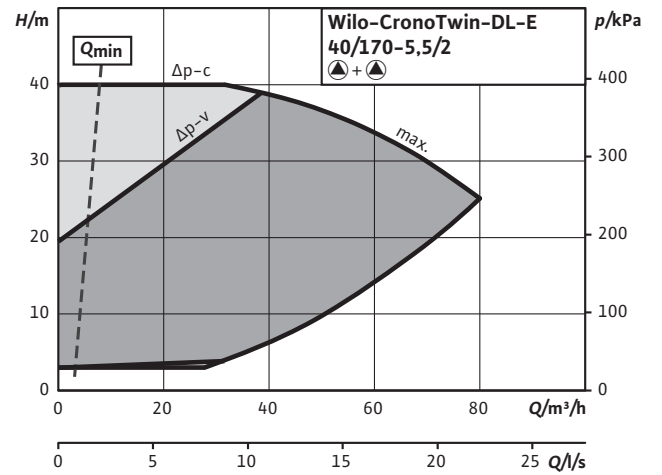
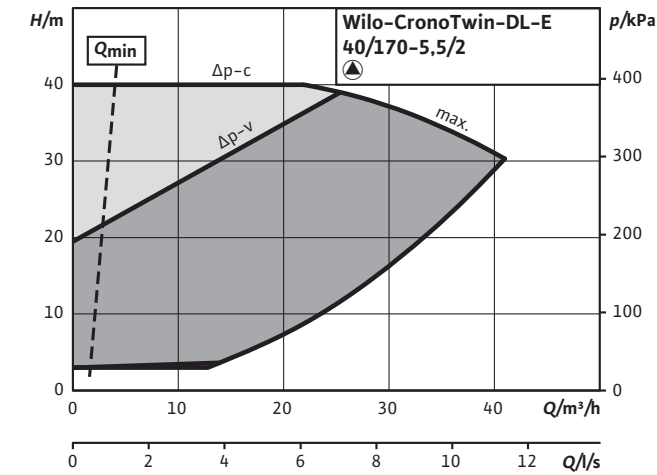
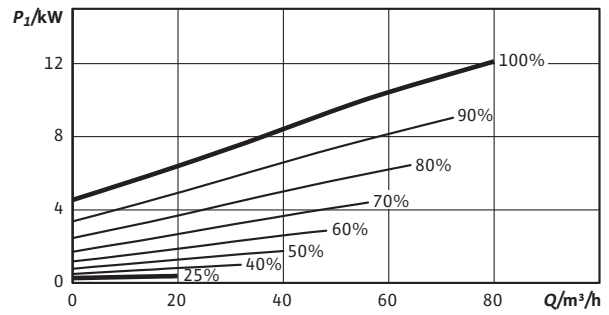
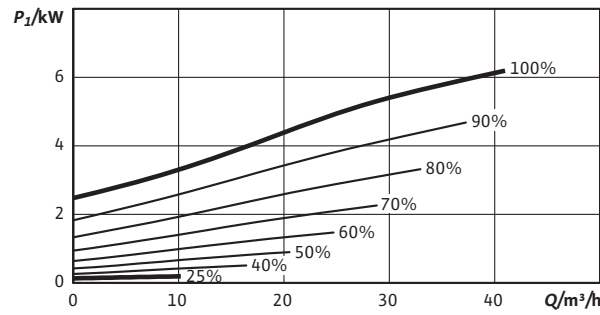
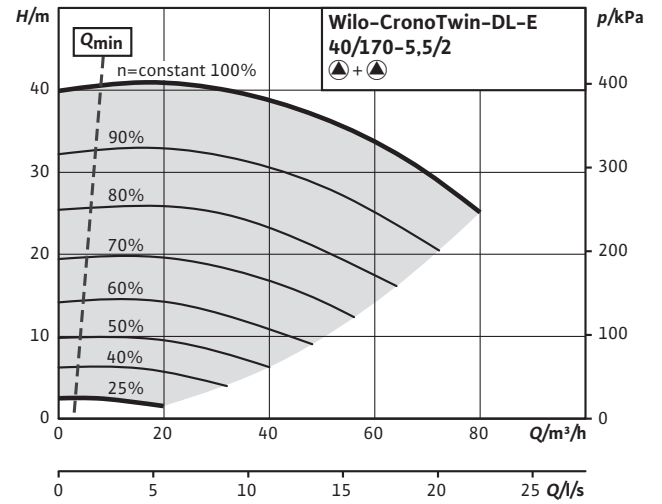
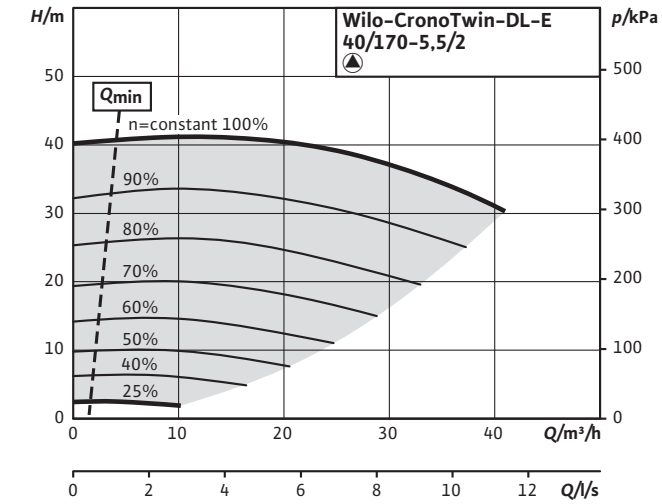

Curve caratteristiche

CronoTwin-DL-E 40/200-7,5/2 (2 poli - funzionamento singolo)

Curve caratteristiche

CronoTwin-DL-E 40/200-7,5/2 (2 poli - funzionamento parallelo)

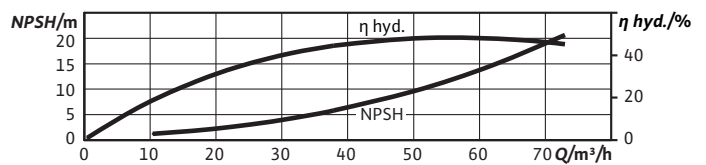
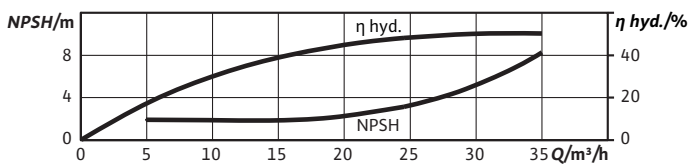
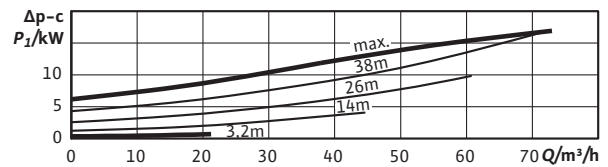
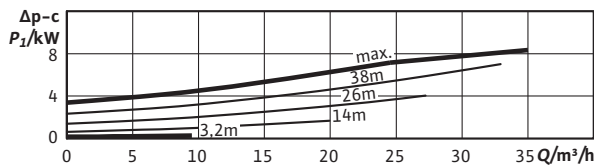
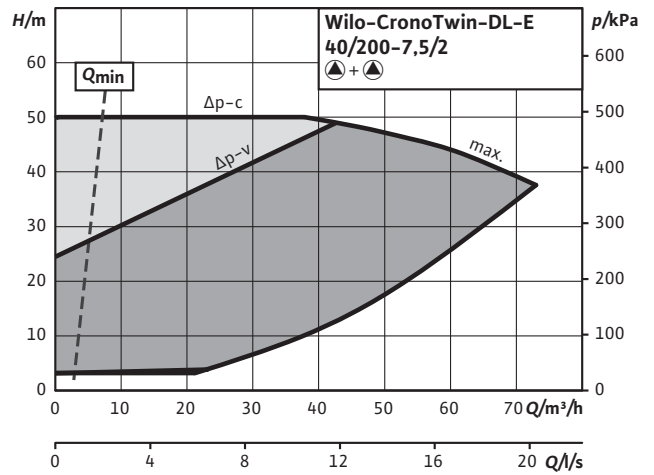
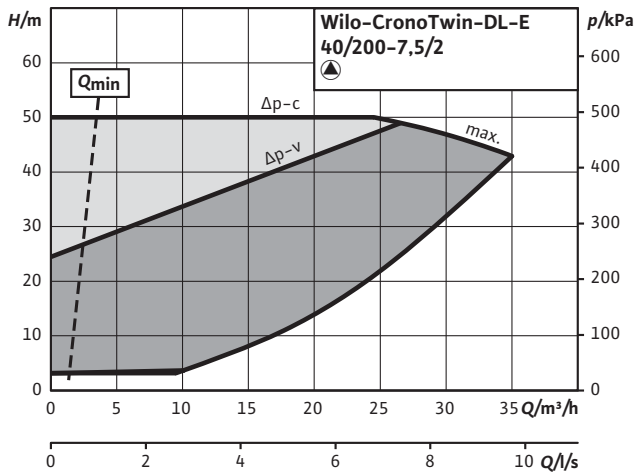
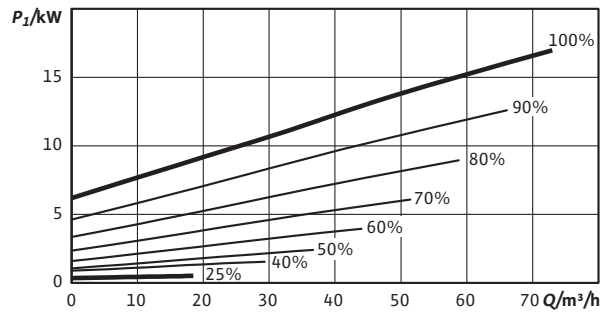
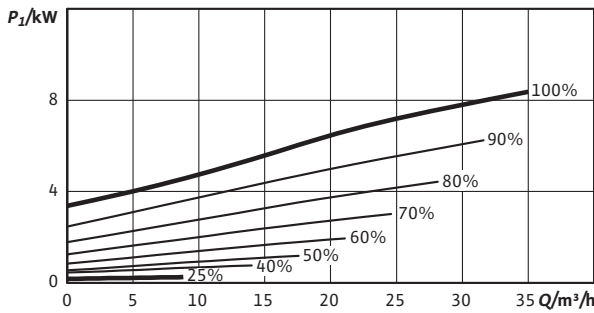
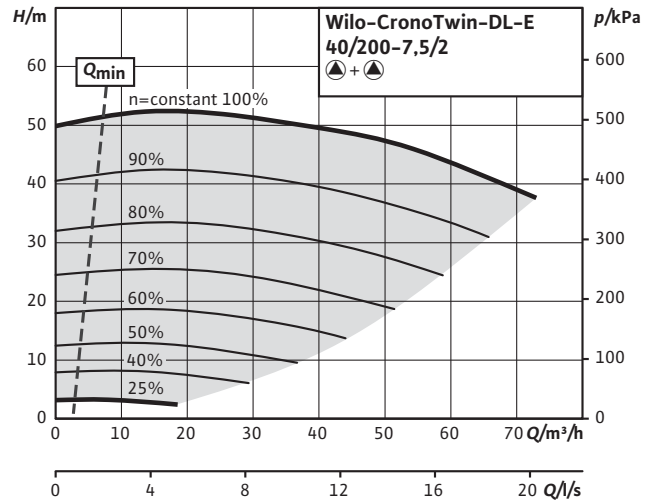
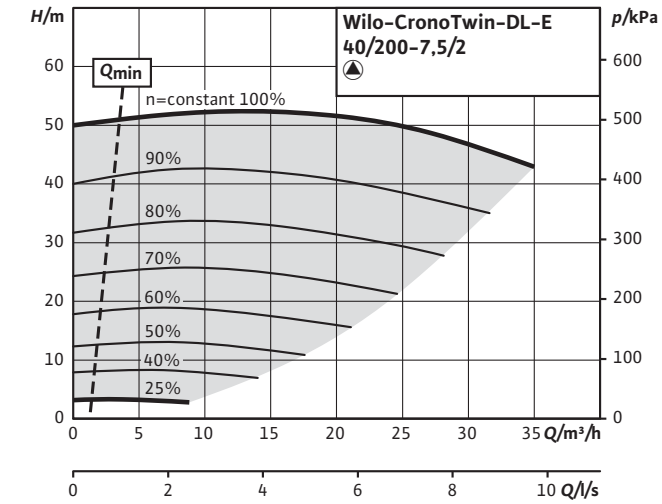

Riscaldamento, condizionamento e refrigerazione

Curve caratteristiche

CronoTwin-DL-E 40/220-11/2 (2 poli - funzionamento singolo)

Curve caratteristiche

CronoTwin-DL-E 40/220-11/2 (2 poli - funzionamento parallelo)

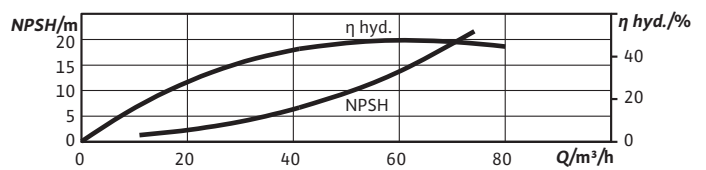
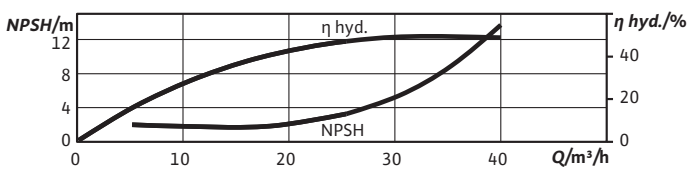
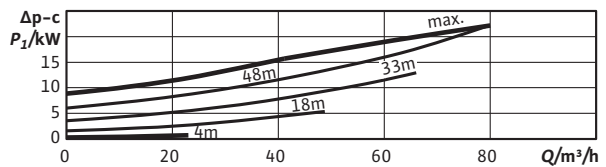
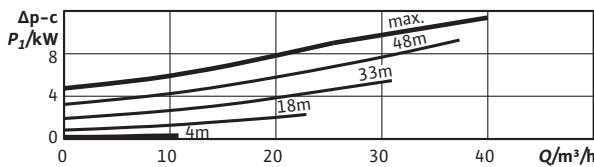
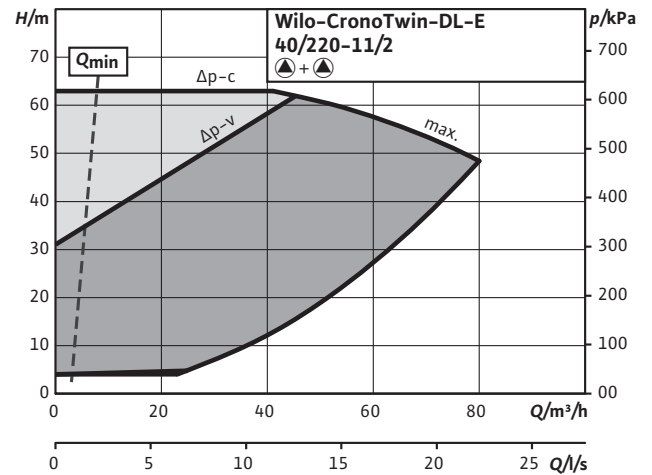
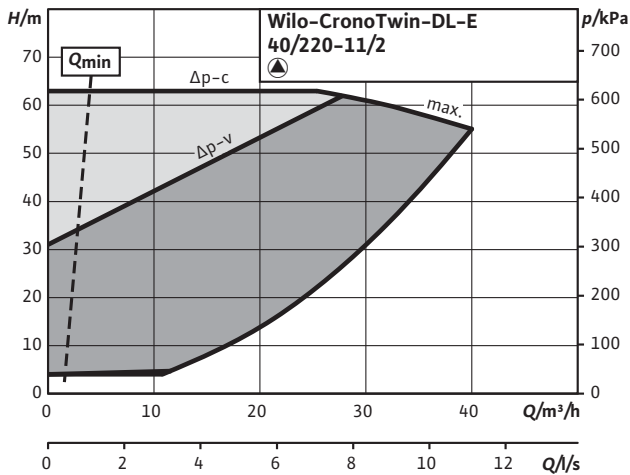
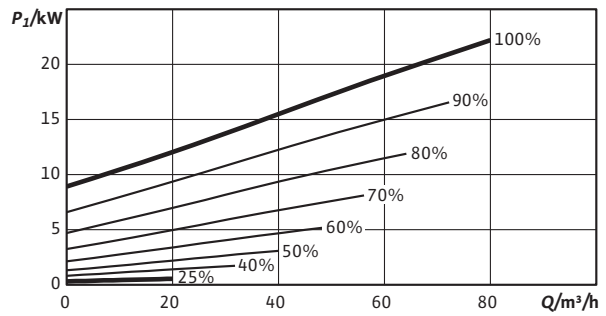
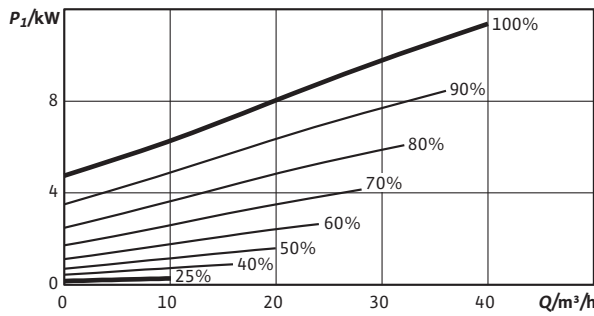
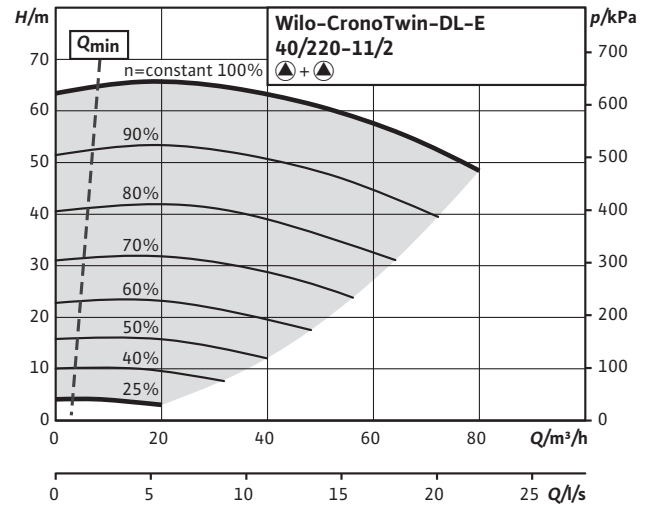
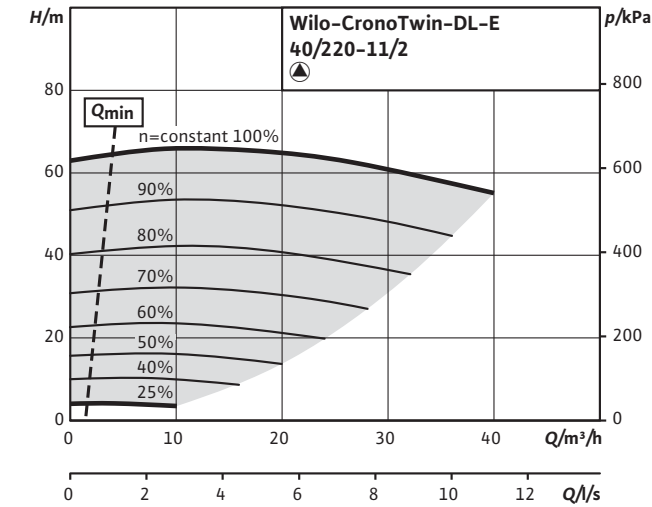



Curve caratteristiche

CronoTwin-DL-E 50/160-5,5/2 (2 poli - funzionamento singolo)

Curve caratteristiche

CronoTwin-DL-E 50/160-5,5/2 (2 poli - funzionamento parallelo)

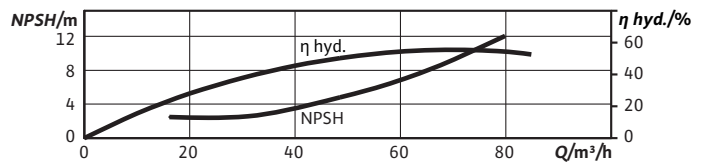
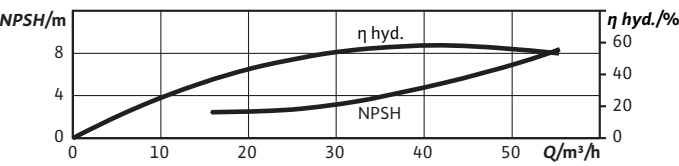
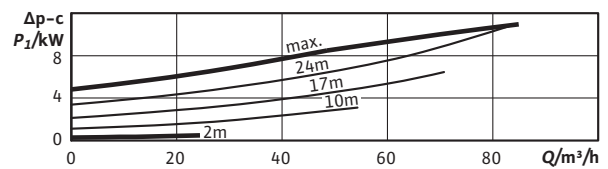
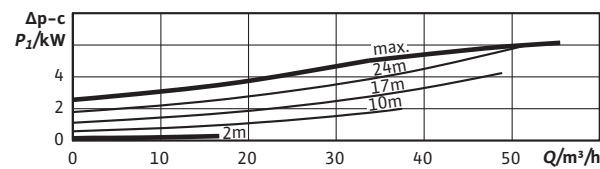
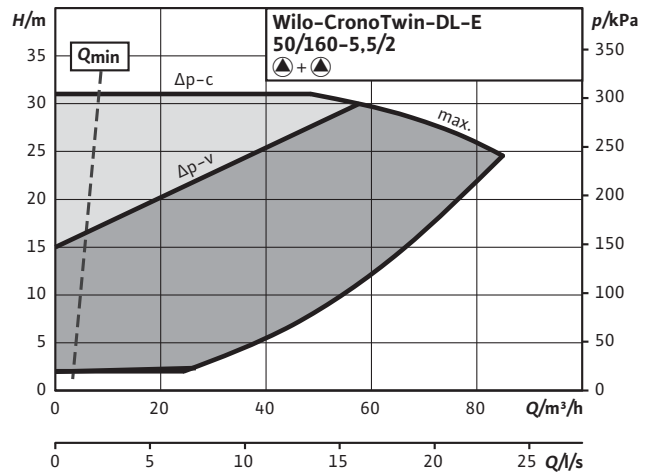
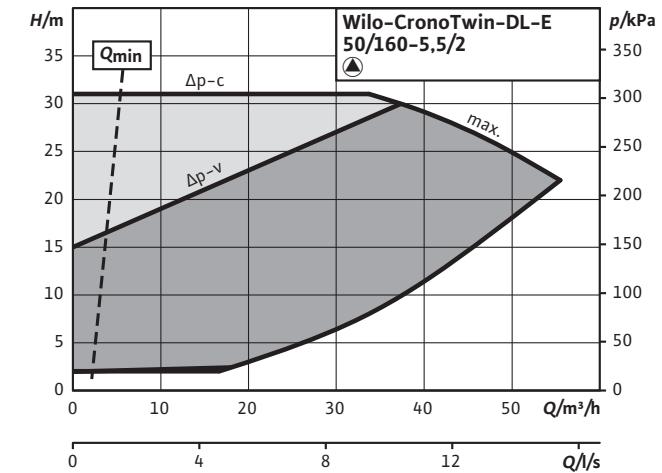
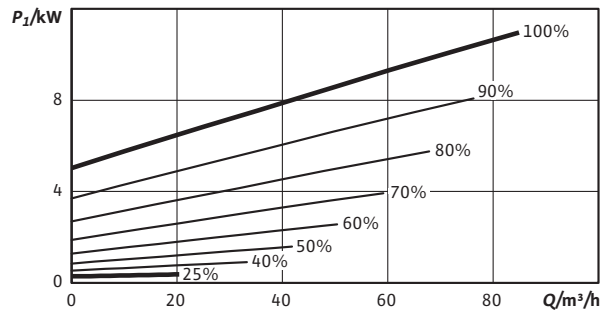
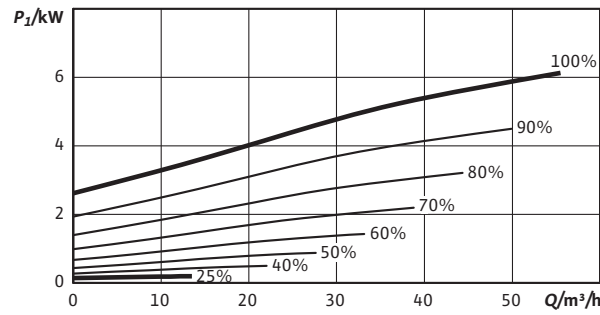
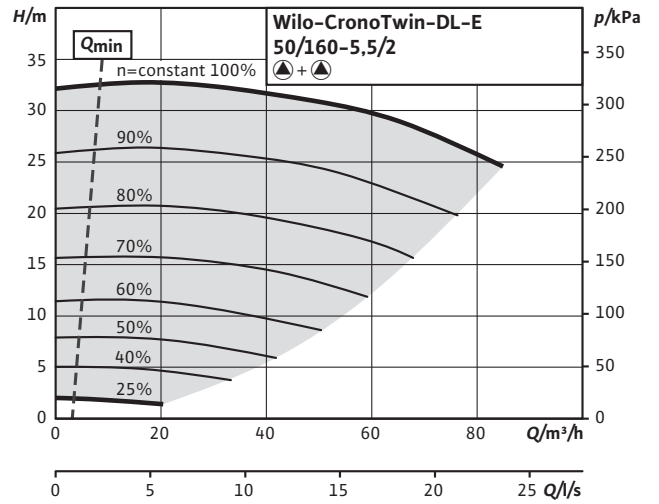
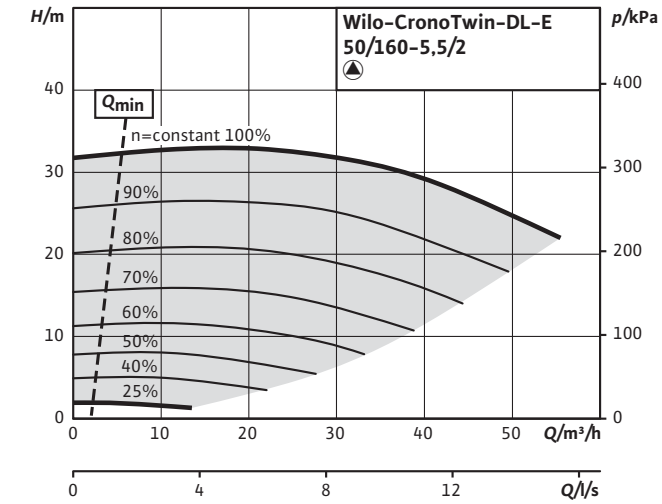

Riscaldamento, condizionamento e refrigerazione

Curve caratteristiche

CronoTwin-DL-E 50/170-7,5/2 (2 poli - funzionamento singolo)

Curve caratteristiche

CronoTwin-DL-E 50/170-7,5/2 (2 poli - funzionamento parallelo)

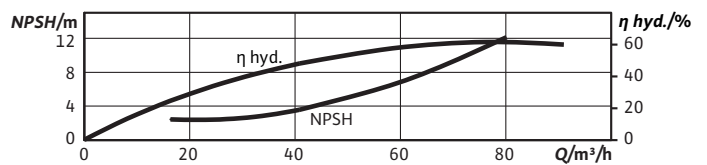
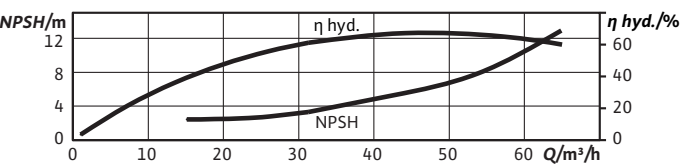
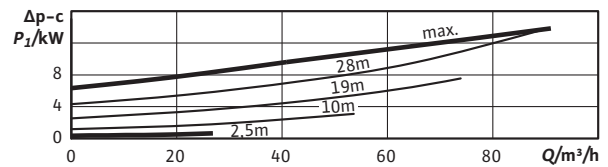
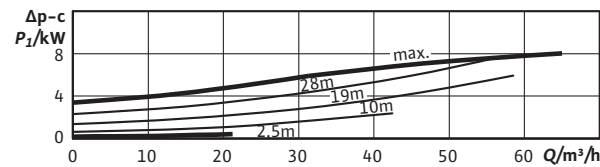
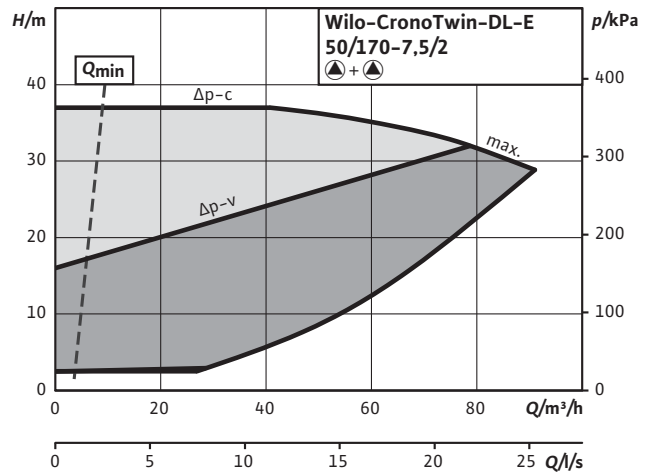
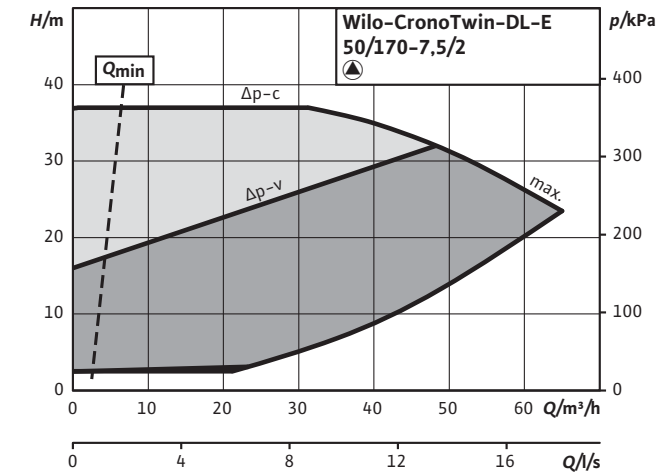
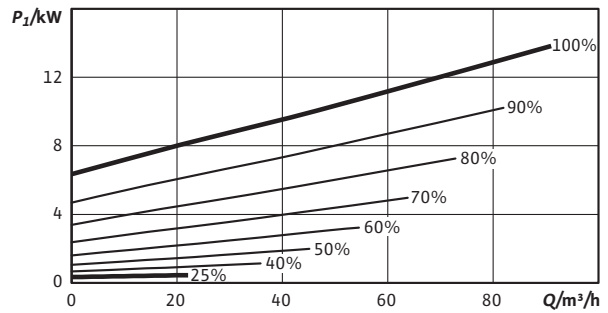
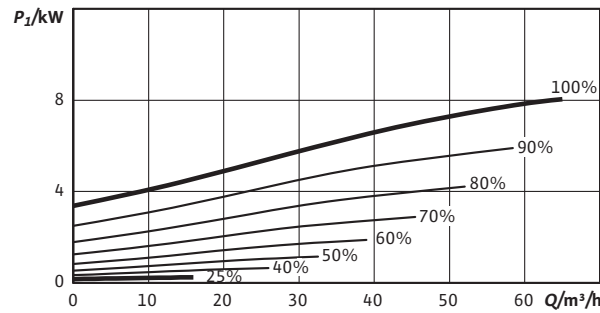
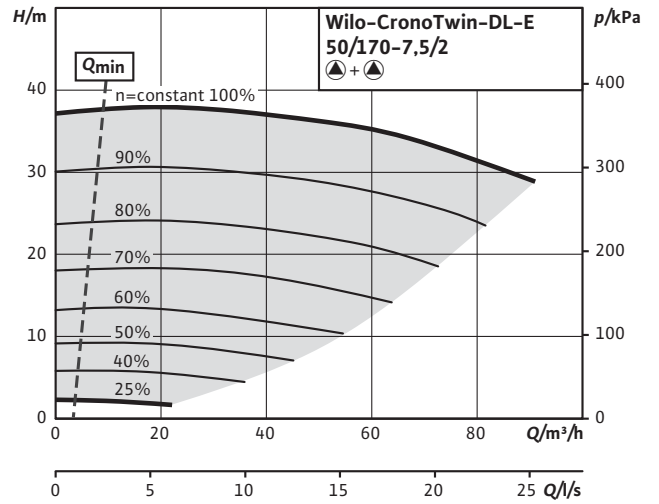
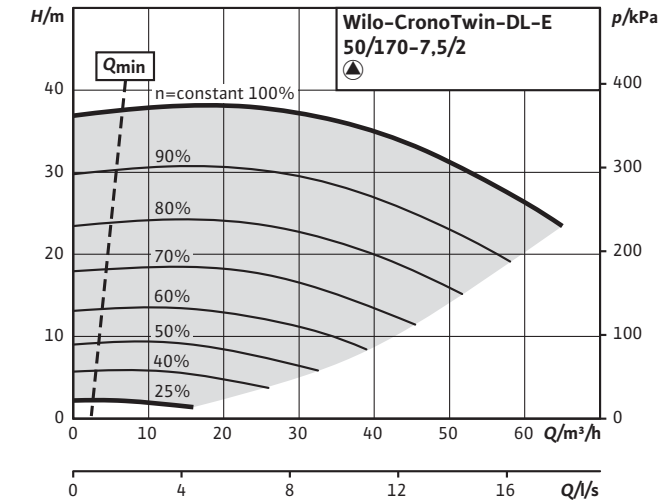

Curve caratteristiche

CronoTwin-DL-E 50/180-7,5/2 (2 poli - funzionamento singolo)

Curve caratteristiche

CronoTwin-DL-E 50/180-7,5/2 (a 2 poli - funzionamento in parallelo)

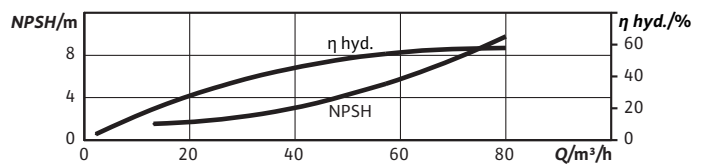
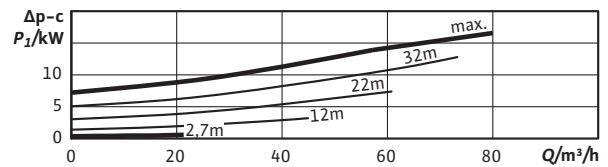
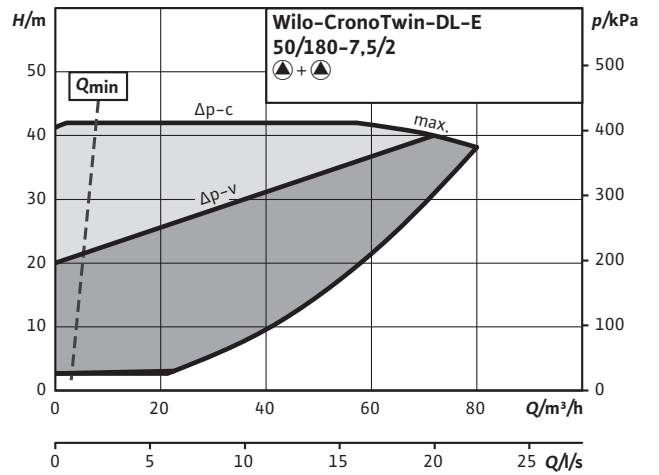
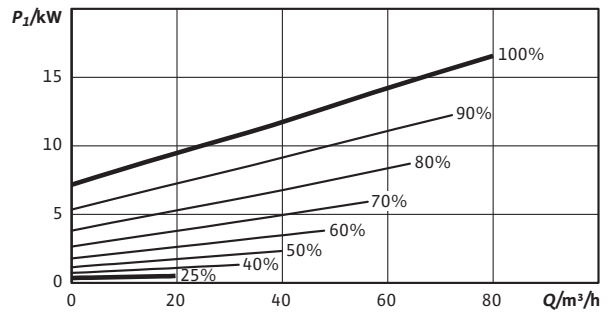
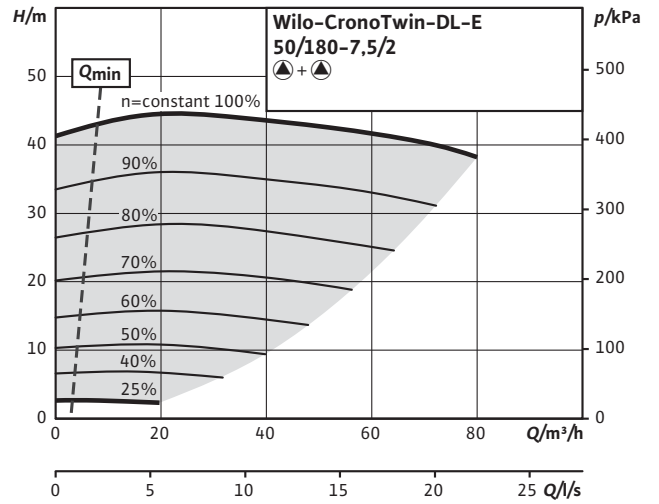
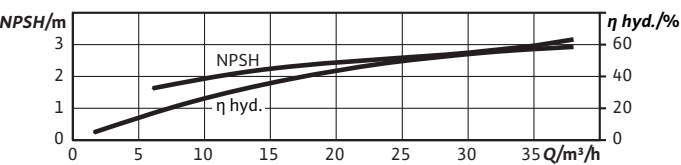
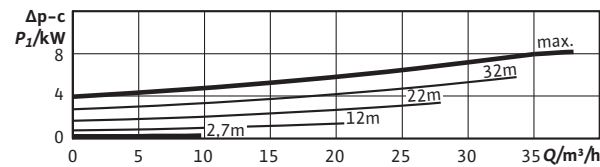
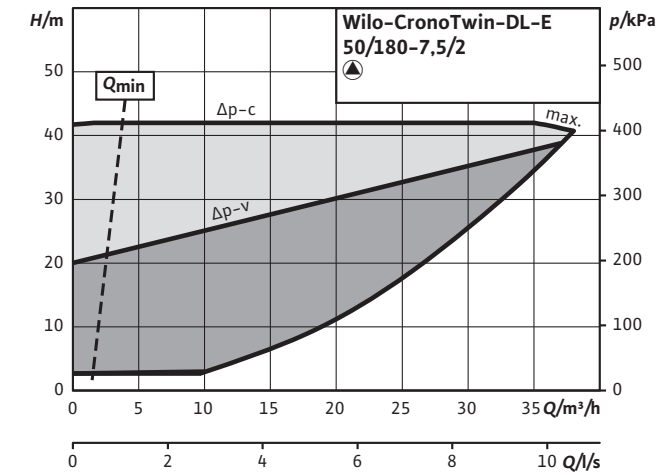
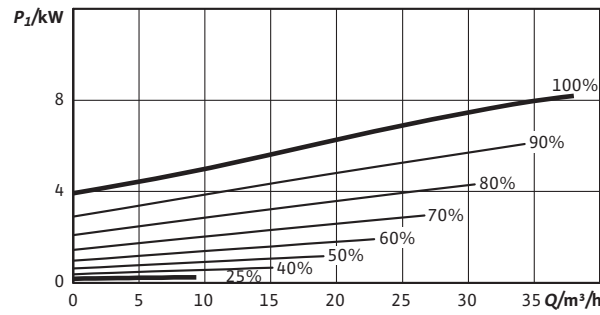
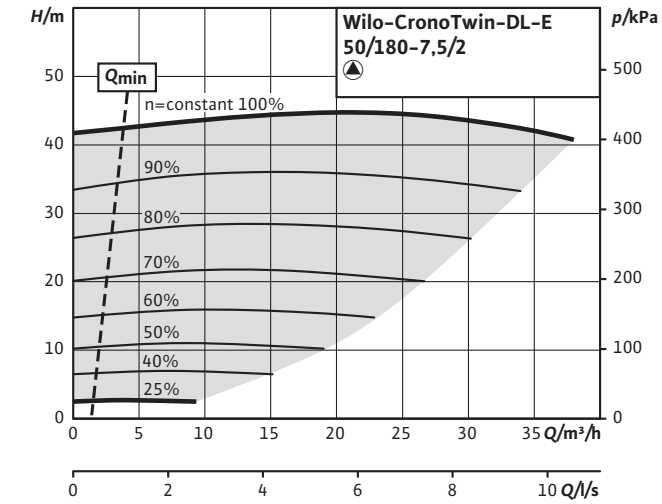

Riscaldamento, condizionamento e refrigerazione

Curve caratteristiche

CronoTwin-DL-E 50/210-11/2 (2 poli - funzionamento singolo)

Curve caratteristiche

CronoTwin-DL-E 50/210-11/2 (2 poli - funzionamento parallelo)

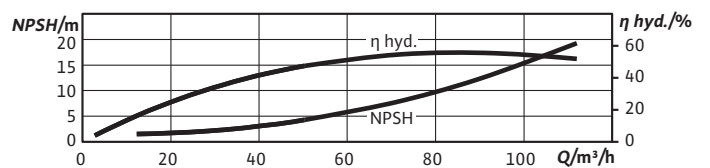
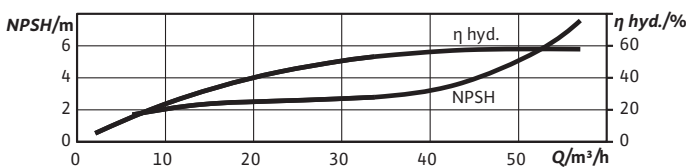
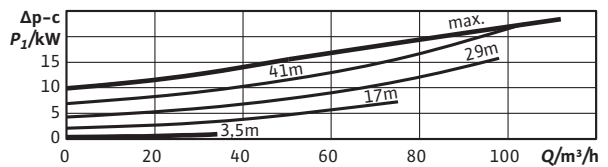
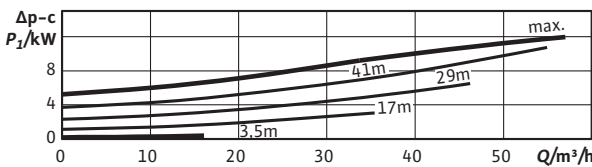
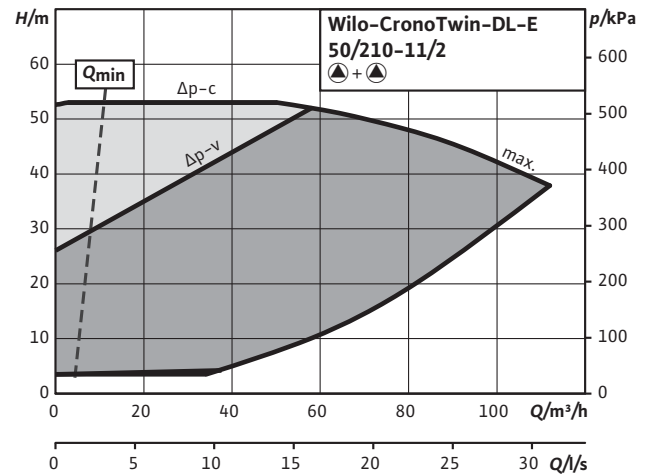
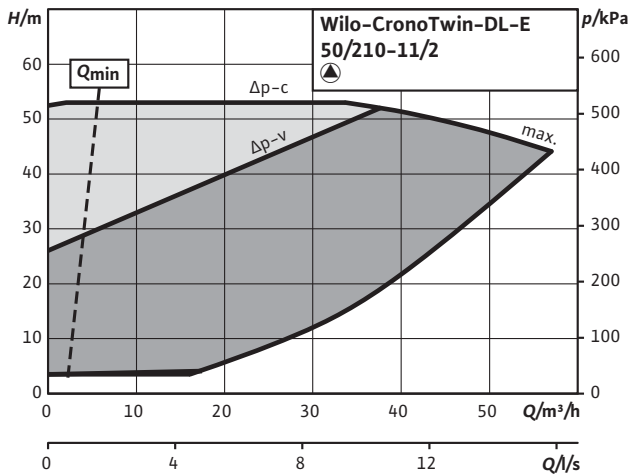
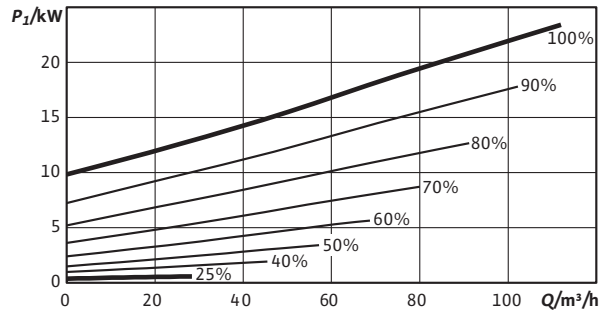
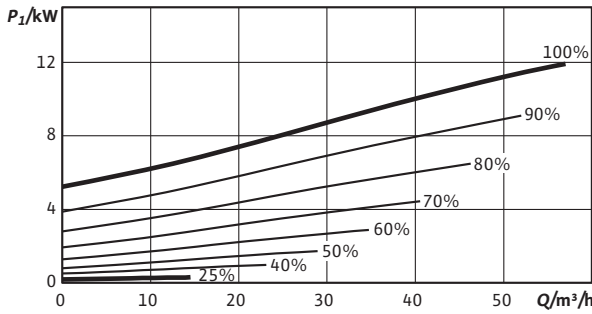
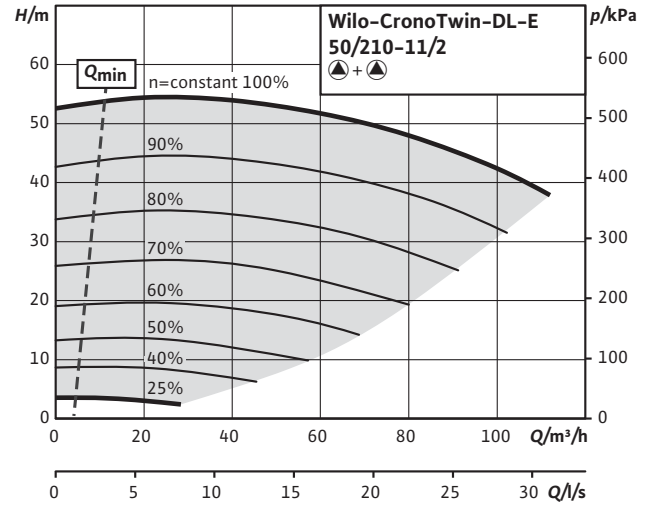
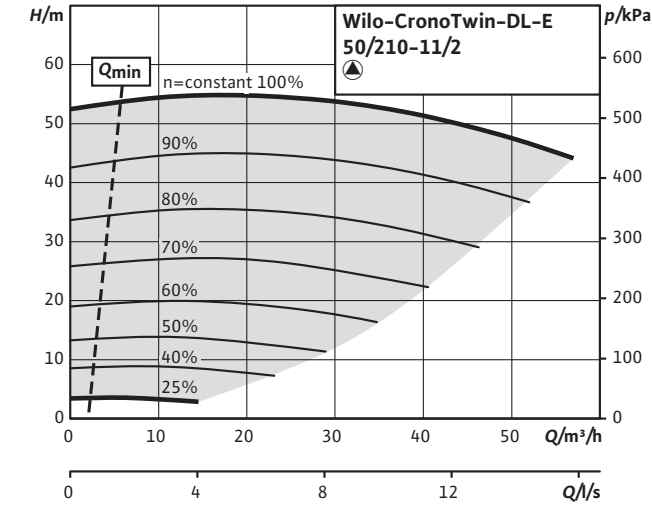

Curve caratteristiche

CronoTwin-DL-E 50/220-15/2 (2 poli - funzionamento singolo)

Curve caratteristiche

CronoTwin-DL-E 50/220-15/2 (2 poli - funzionamento parallelo)

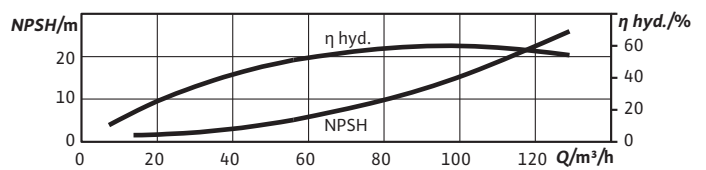
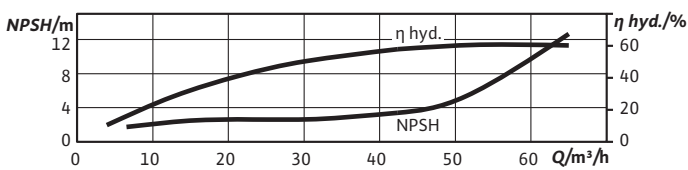
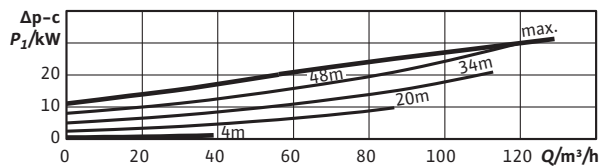
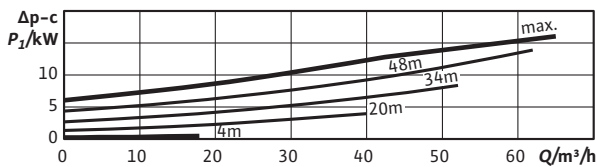
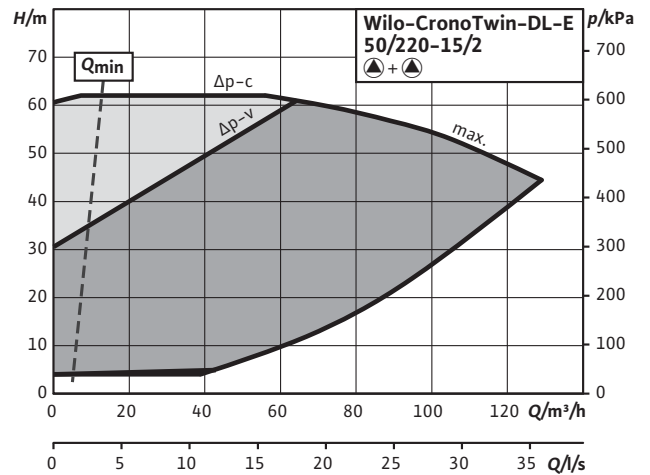
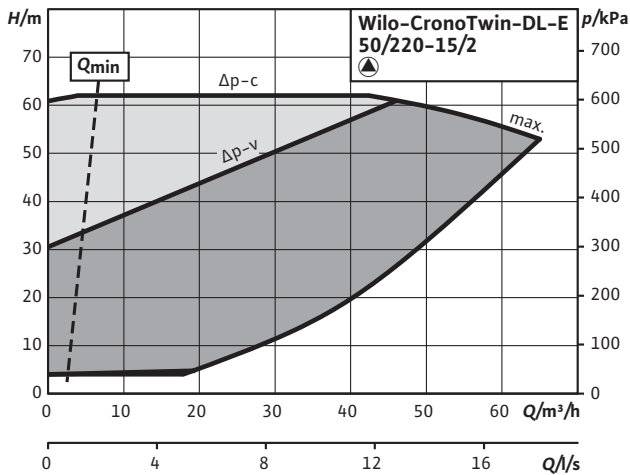
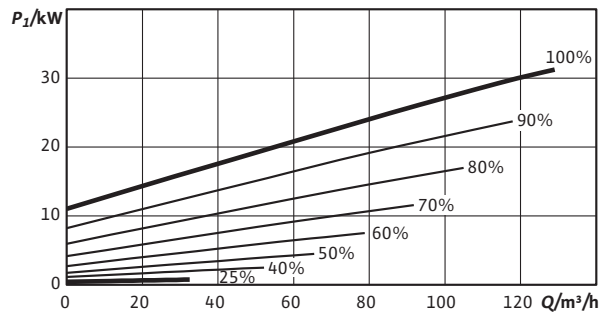
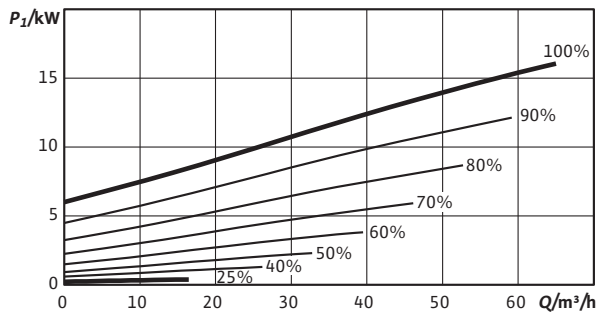
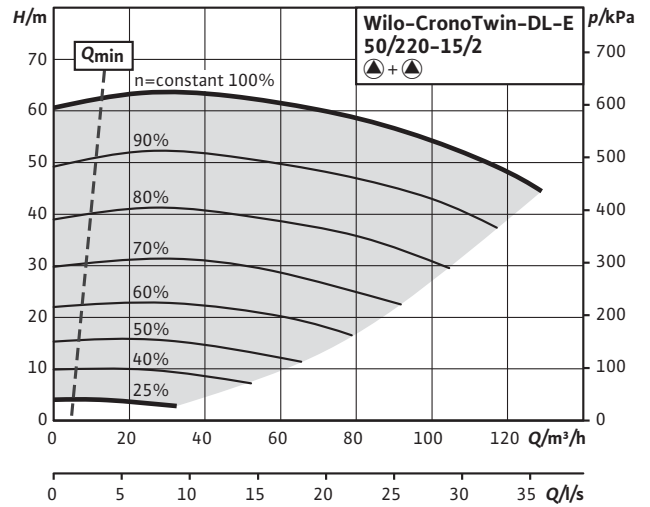
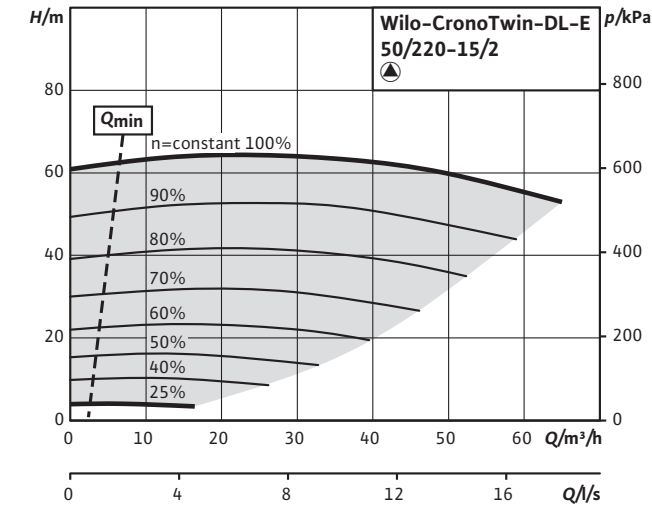

Riscaldamento, condizionamento e refrigerazione

Curve caratteristiche

CronoTwin-DL-E 65/150-5,5/2 (2 poli - funzionamento singolo)

Curve caratteristiche

CronoTwin-DL-E 65/150-5,5/2 (2 poli - funzionamento parallelo)

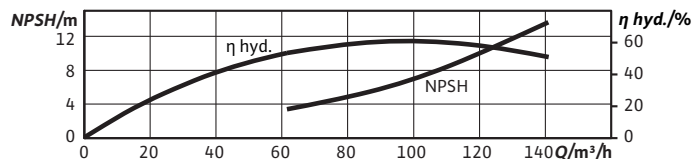
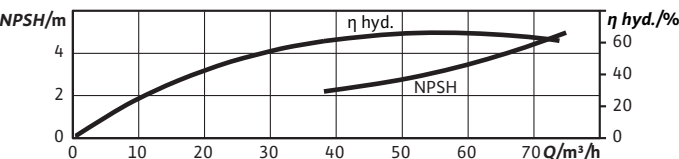
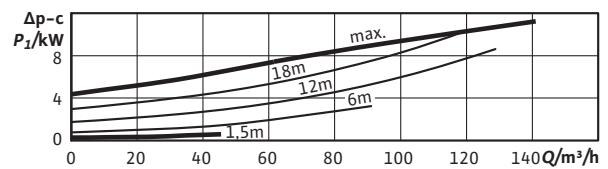
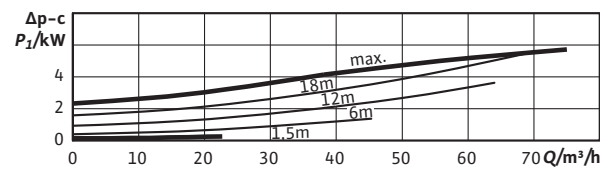
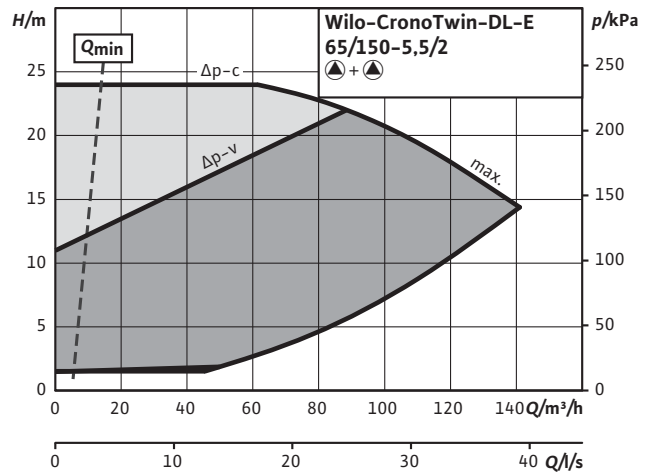
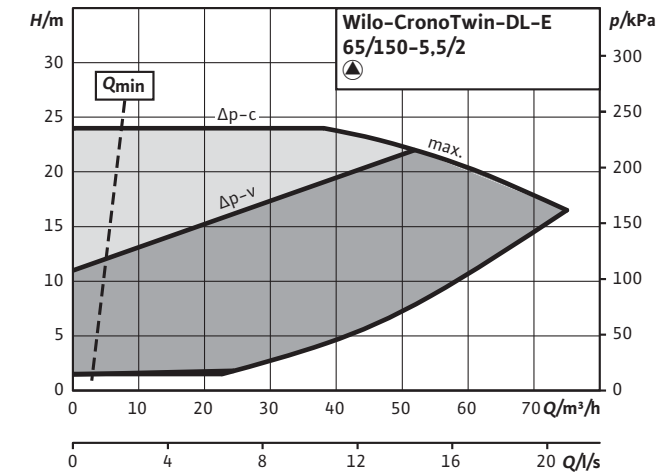
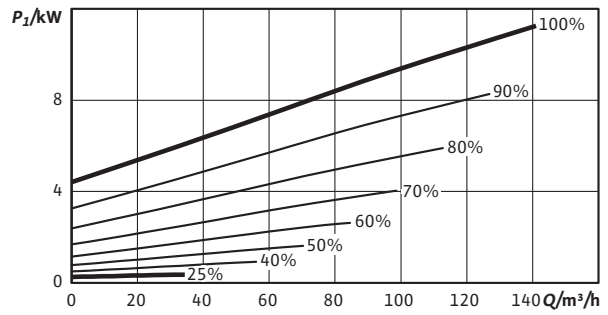
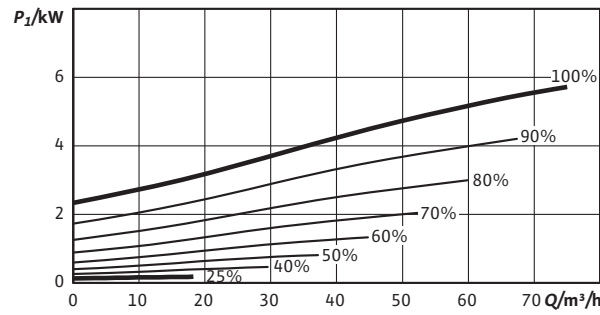
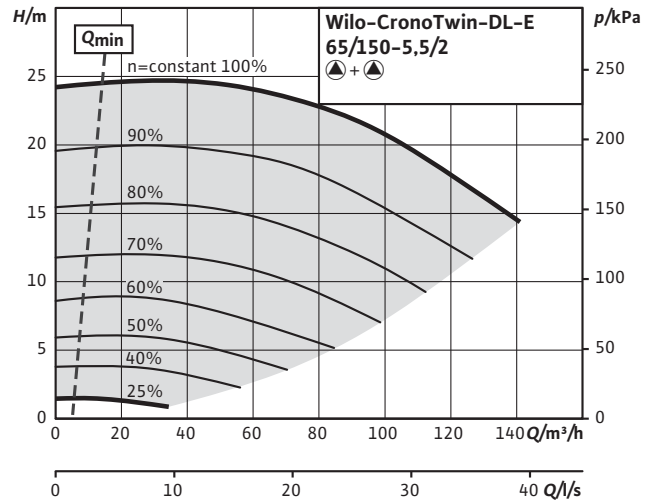
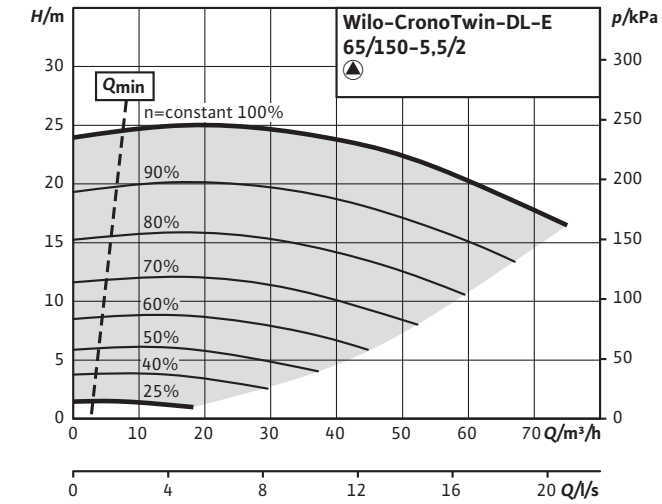

Curve caratteristiche

CronoTwin-DL-E 65/160-7,5/2 (2 poli - funzionamento singolo)

Curve caratteristiche

CronoTwin-DL-E 65/160-7,5/2 (2 poli - funzionamento parallelo)

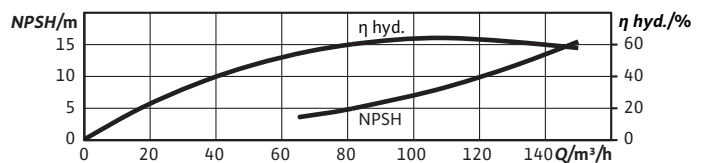
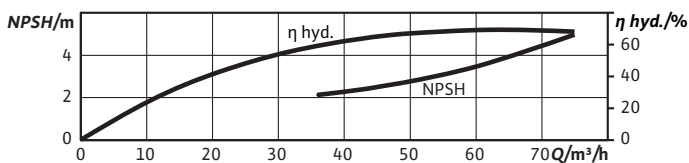
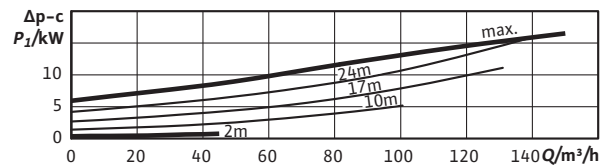
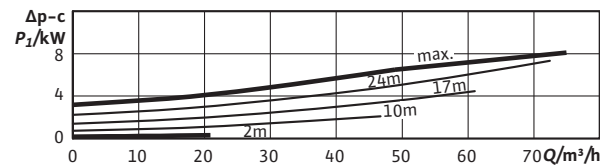
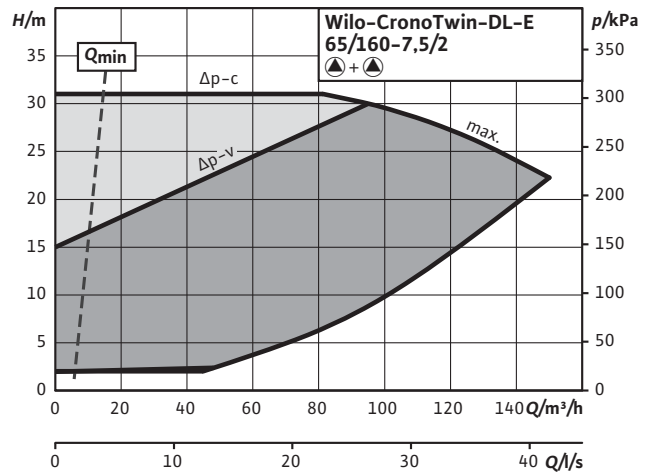
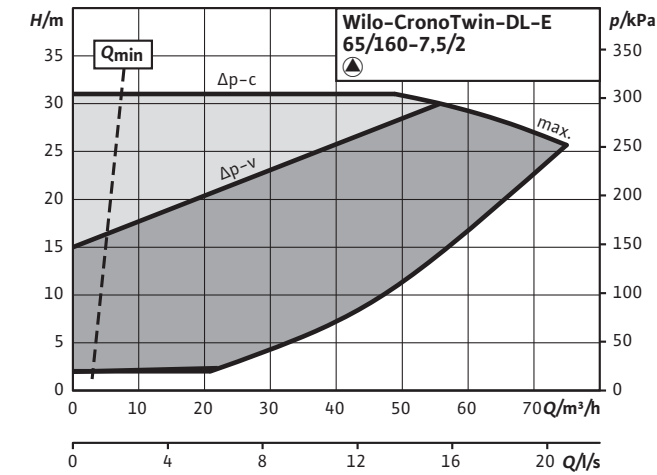
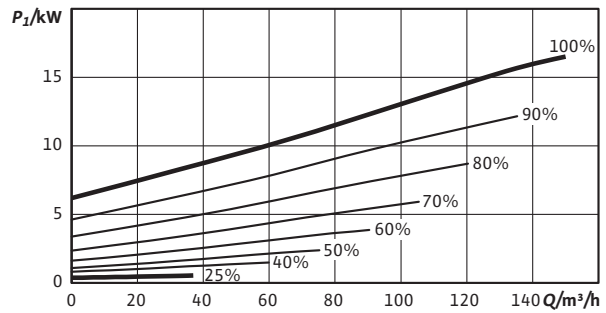
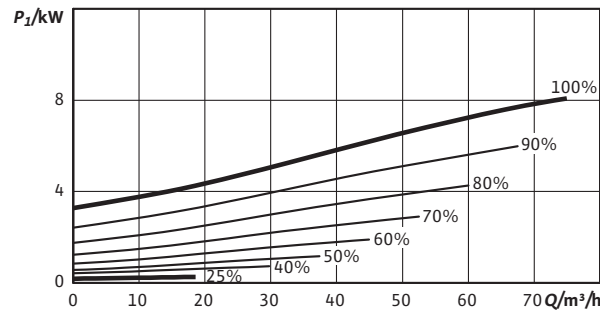
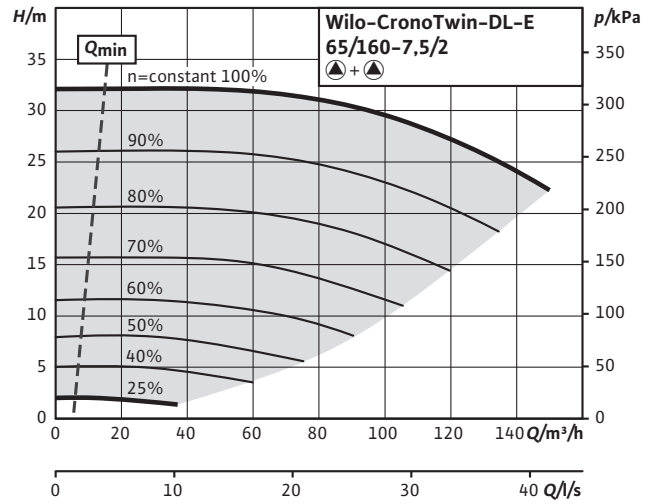
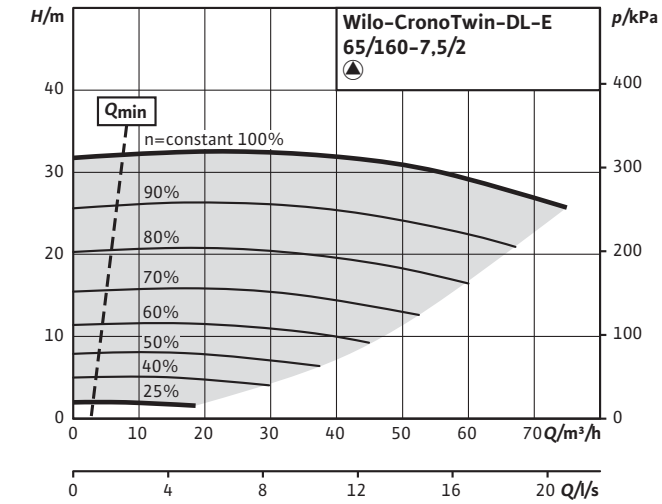

Riscaldamento, condizionamento e refrigerazione

Curve caratteristiche

CronoTwin-DL-E 65/170-11/2 (2 poli - funzionamento singolo)

Curve caratteristiche

CronoTwin-DL-E 65/170-11/2 (2 poli - funzionamento parallelo)

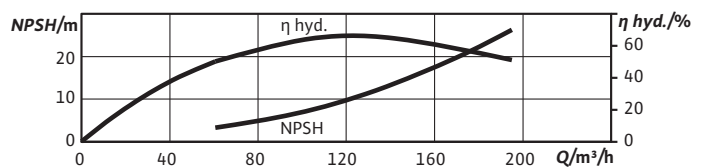
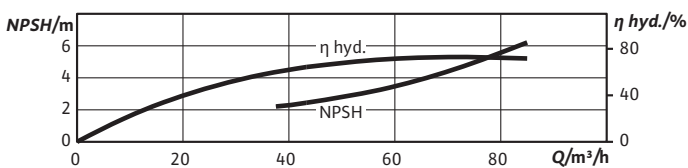
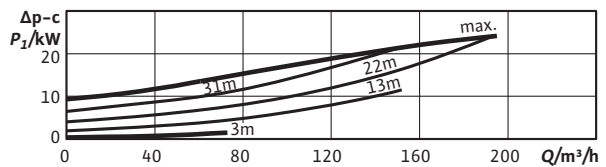
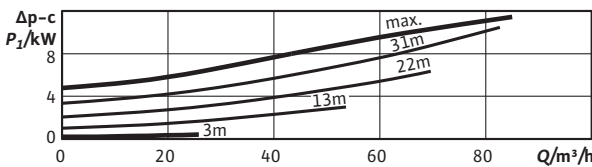
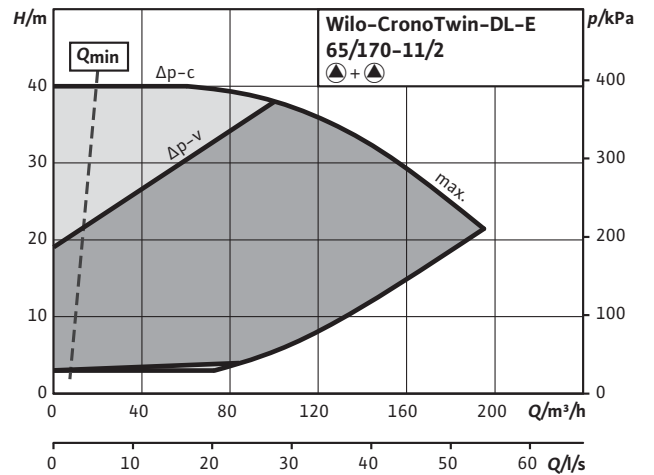
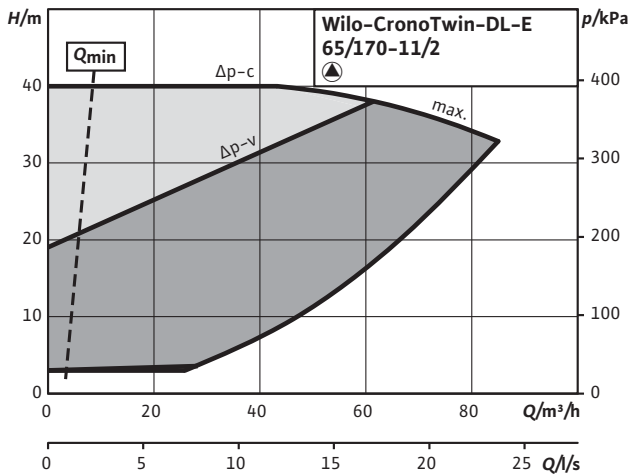
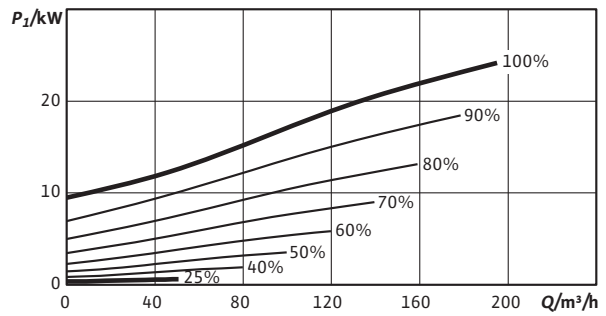
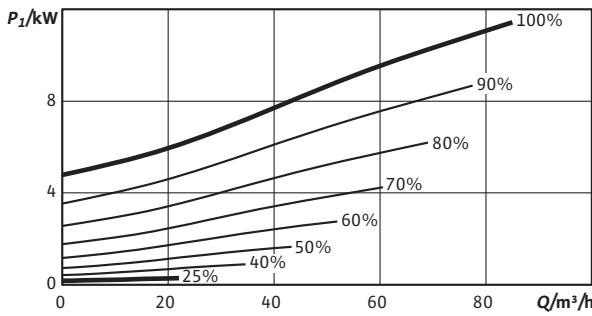
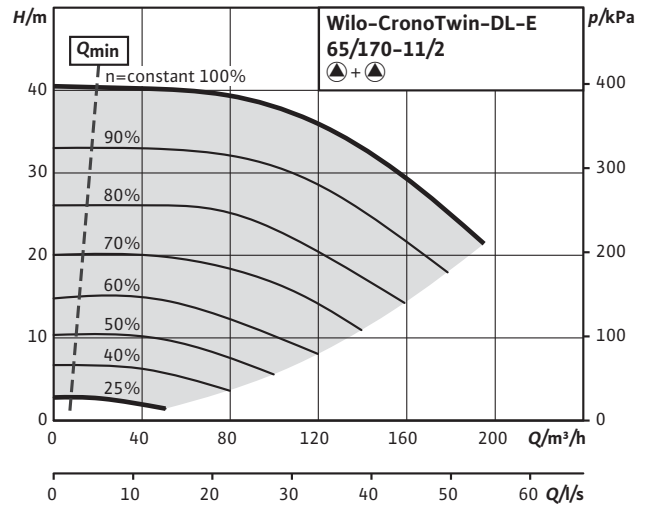
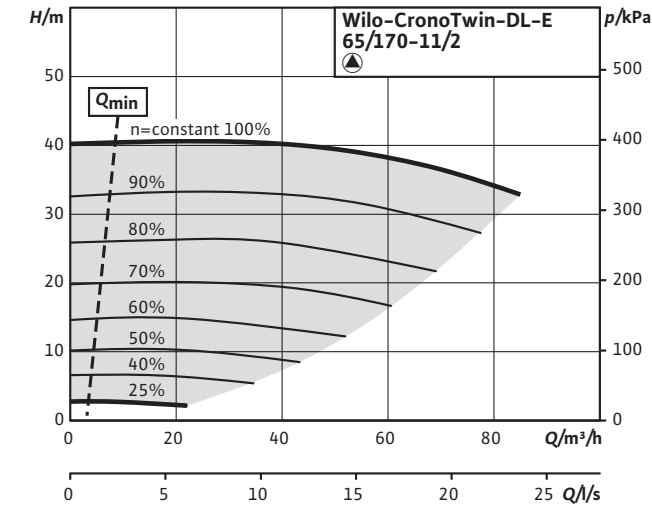



Curve caratteristiche

CronoTwin-DL-E 65/200-15/2 (2 poli - funzionamento singolo)

Curve caratteristiche

CronoTwin-DL-E 65/200-15/2 (2 poli - funzionamento parallelo)

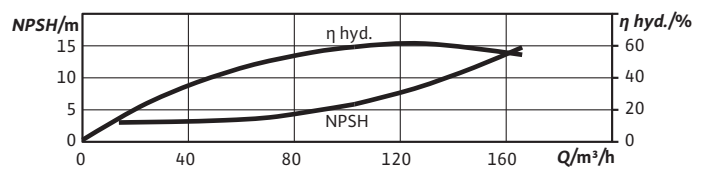
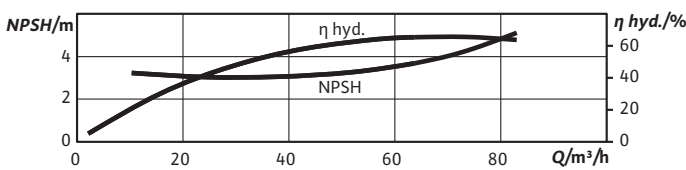
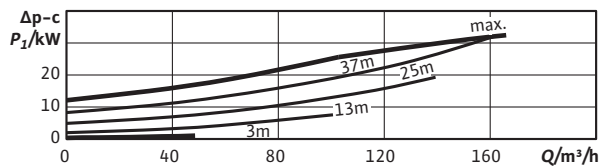
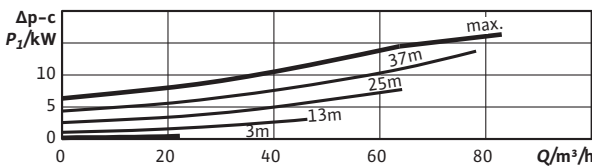
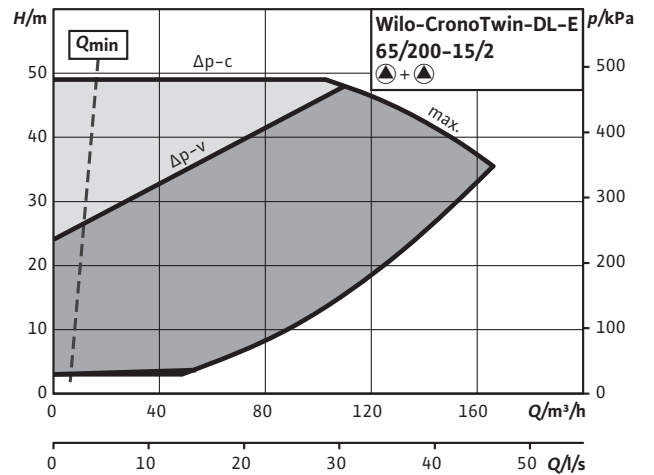
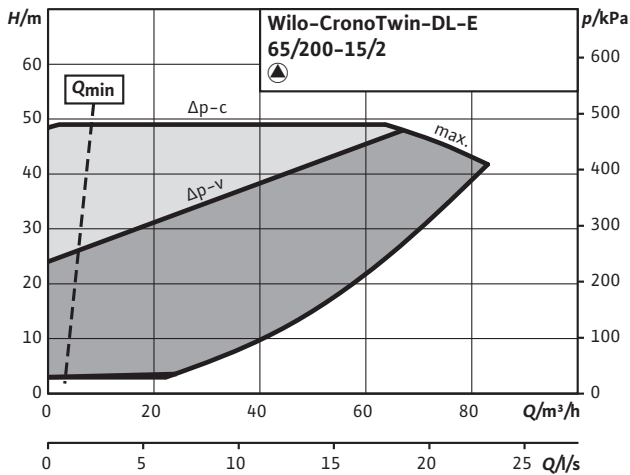
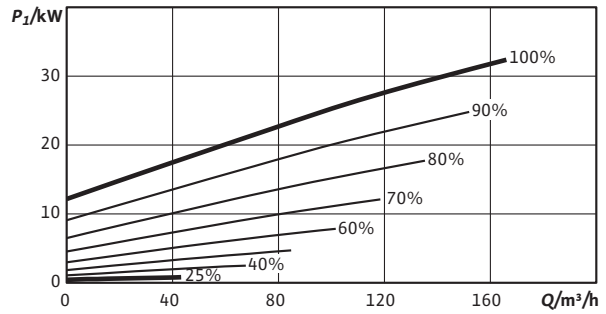
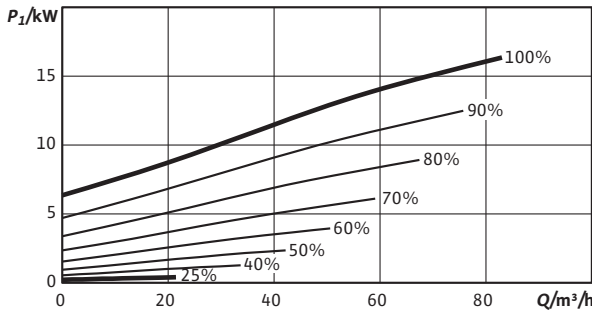
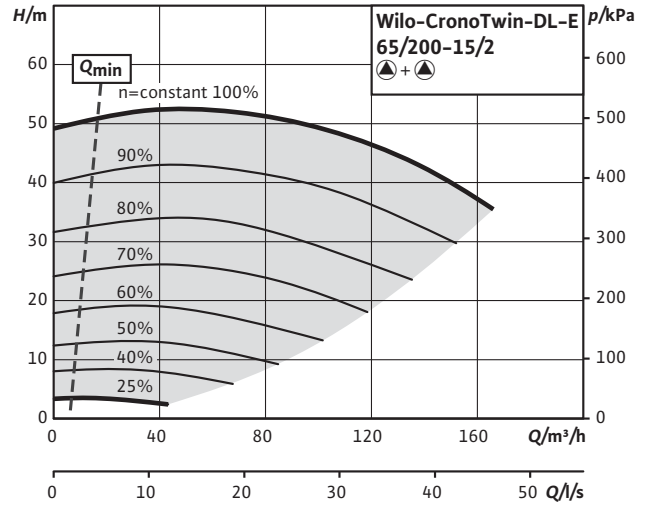
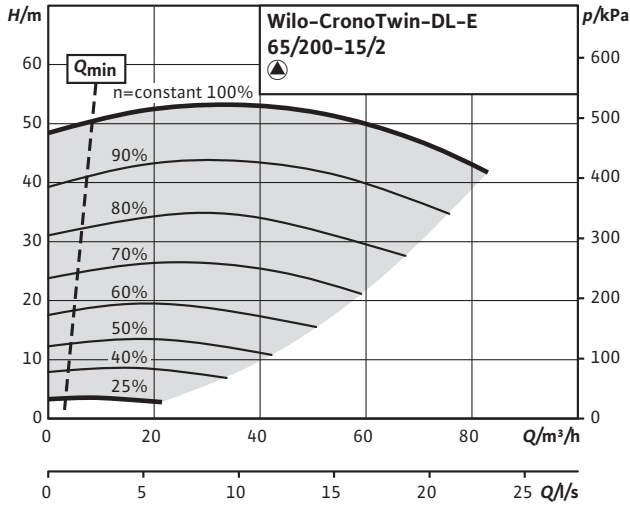

Riscaldamento, condizionamento e refrigerazione

Curve caratteristiche

CronoTwin-DL-E 65/210-18,5/2 (2 poli - funzionamento singolo)

Curve caratteristiche

CronoTwin-DL-E 65/210-18,5/2 (2 poli - funzionamento parallelo)

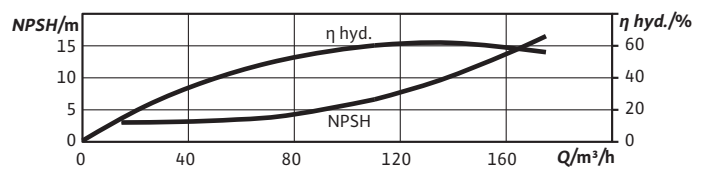
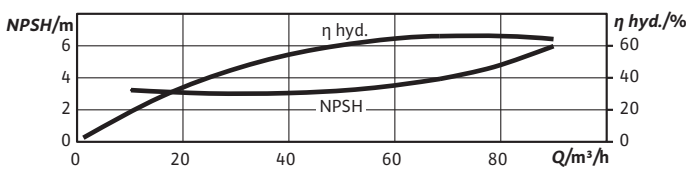
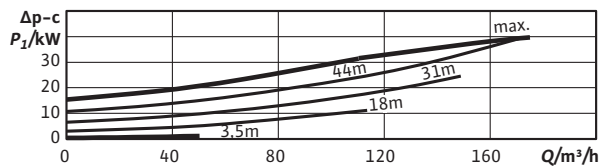
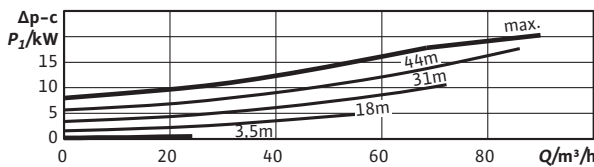
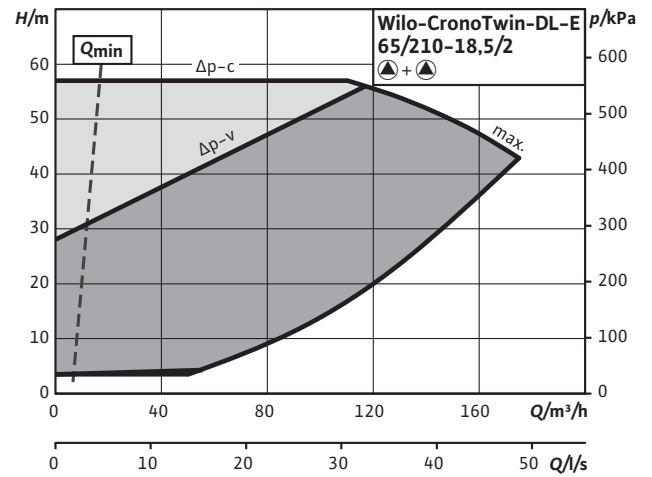
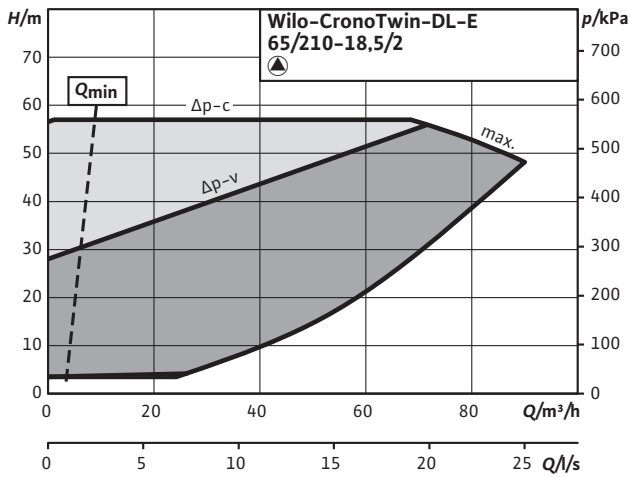
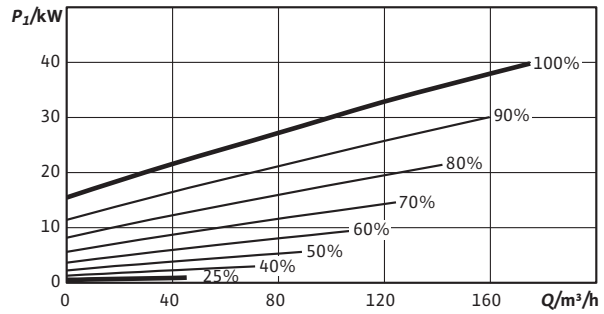
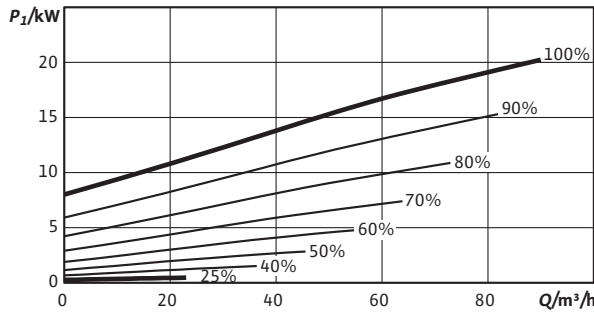
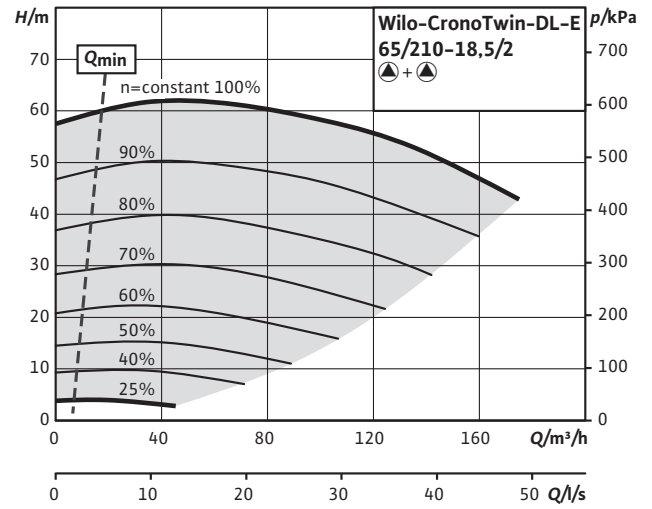
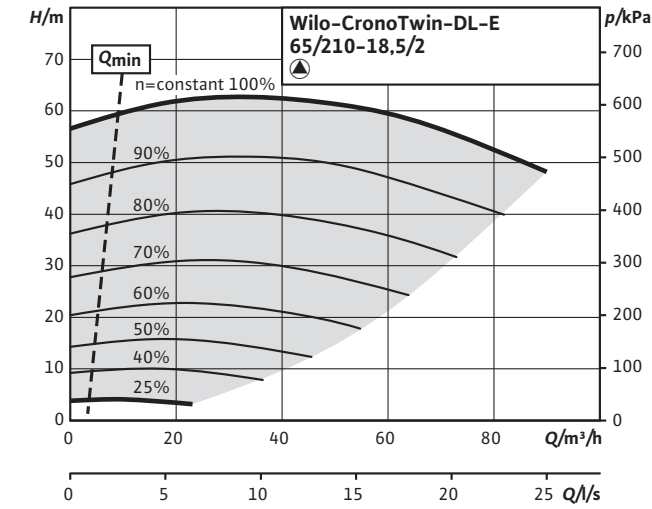

Curve caratteristiche

CronoTwin-DL-E 65/220-22/2 (2 poli - funzionamento singolo)

Curve caratteristiche

CronoTwin-DL-E 65/220-22/2 (2 poli - funzionamento parallelo)

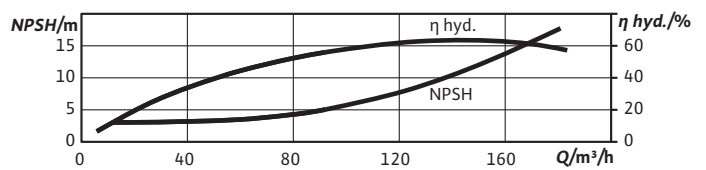
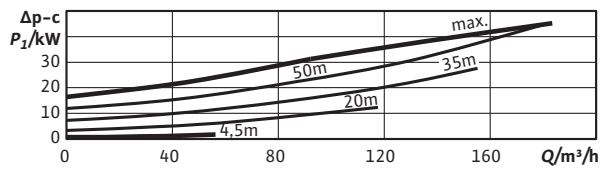
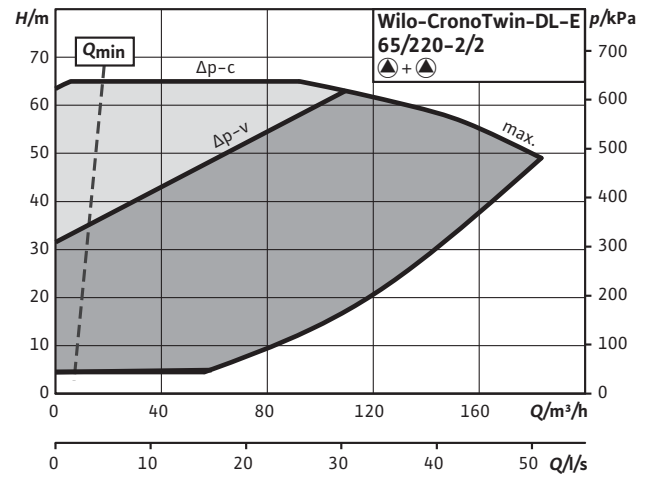
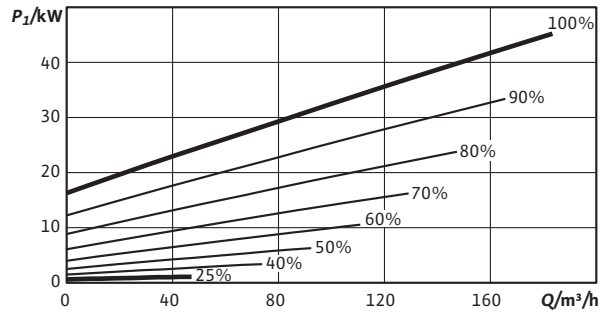
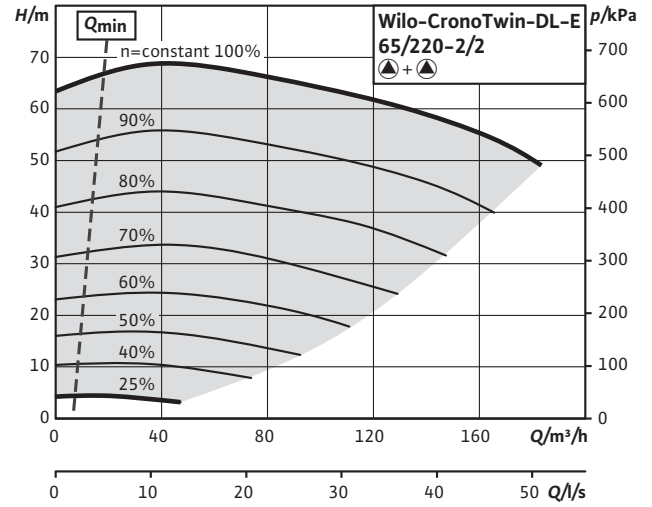
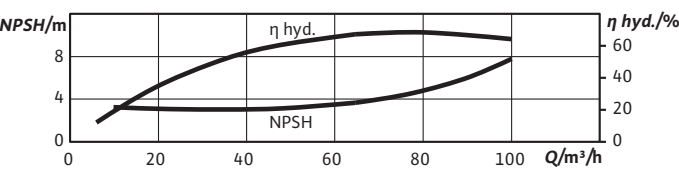
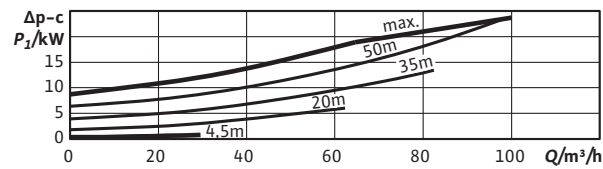
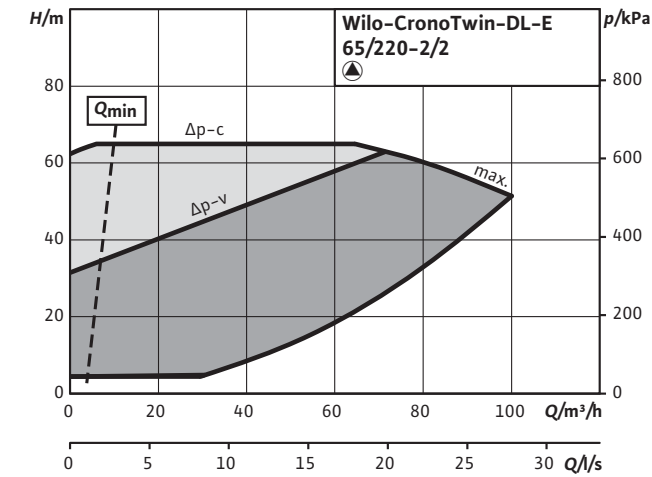
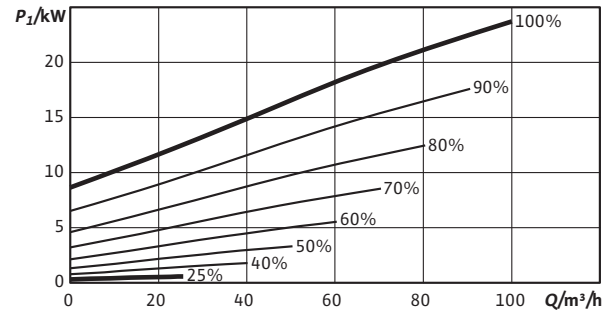
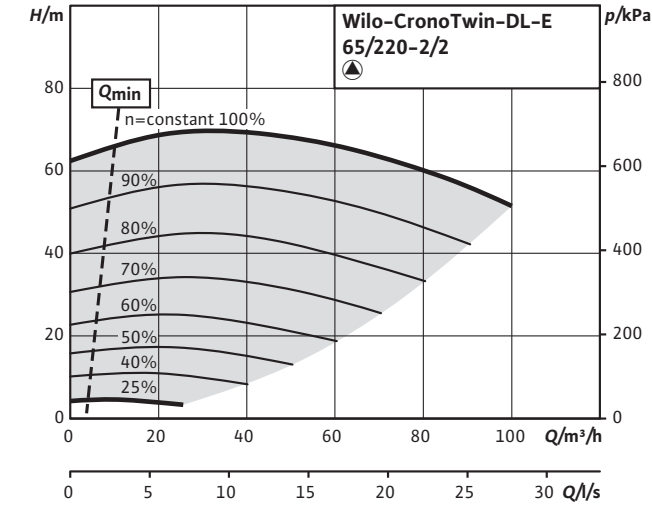

Riscaldamento, condizionamento e refrigerazione

Curve caratteristiche

CronoTwin-DL-E 80/130-5,5/2 (2 poli - funzionamento singolo)

Curve caratteristiche

CronoTwin-DL-E 80/130-5,5/2 (2 poli - funzionamento parallelo)

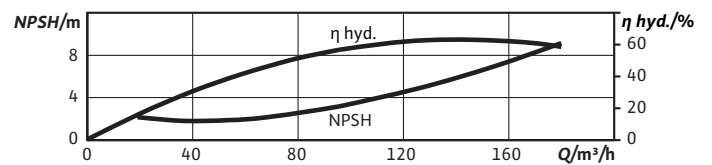
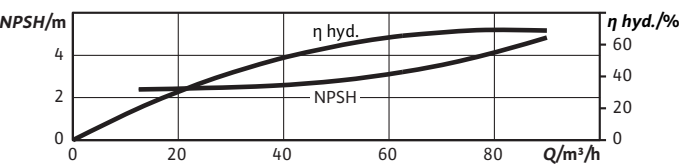
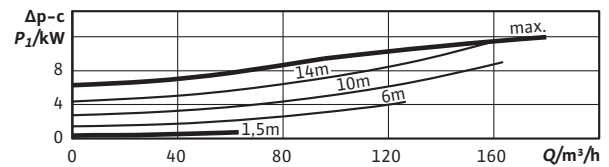
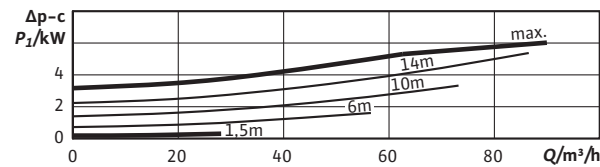
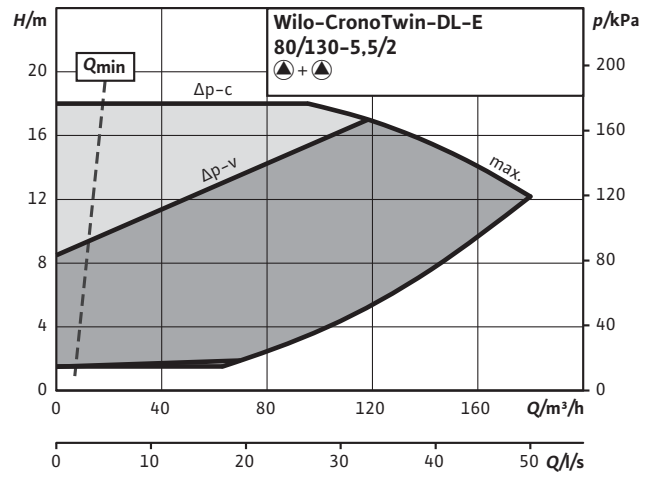
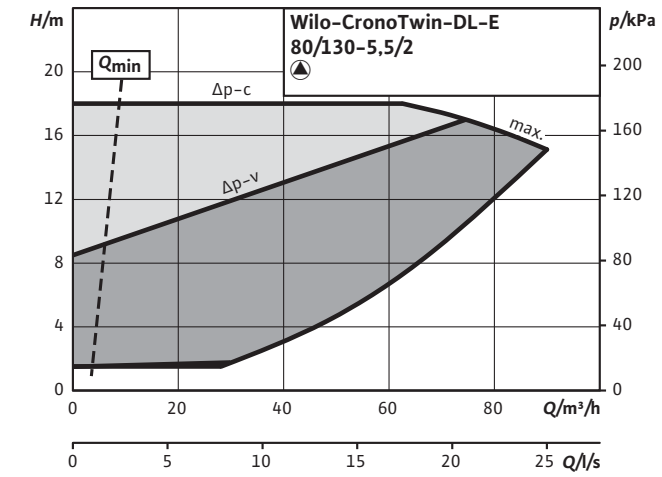
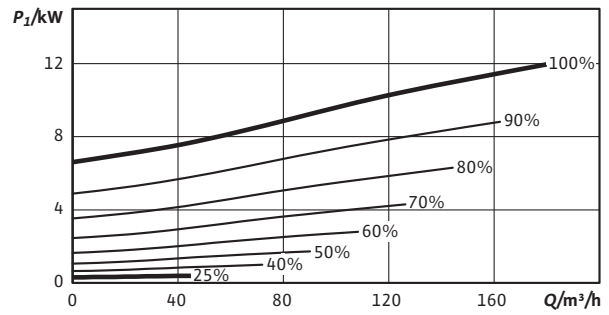
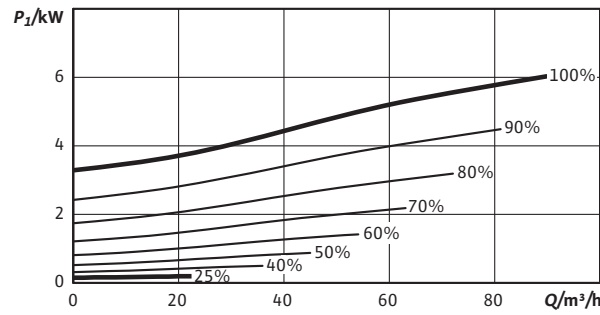
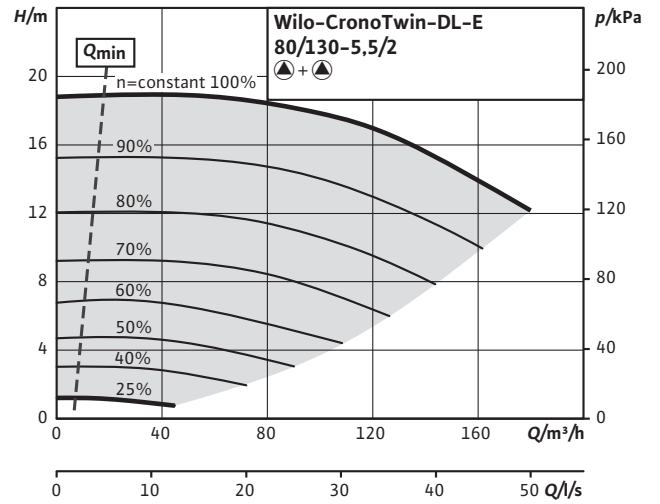
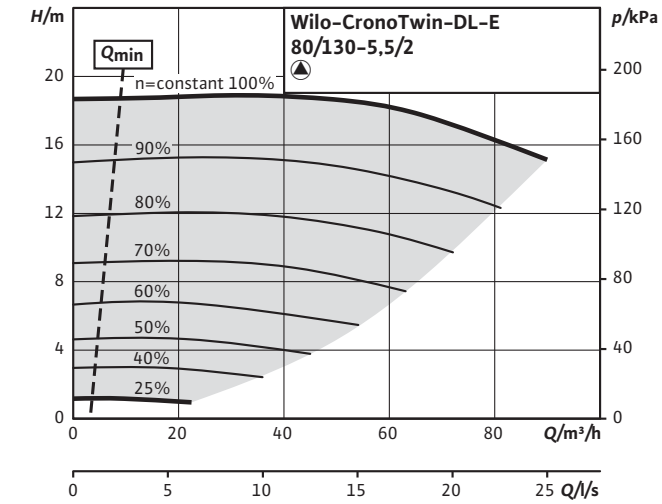

Curve caratteristiche

CronoTwin-DL-E 80/140-7,5/2 (2 poli - funzionamento singolo)

Curve caratteristiche

CronoTwin-DL-E 80/140-7,5/2 (2 poli - funzionamento parallelo)

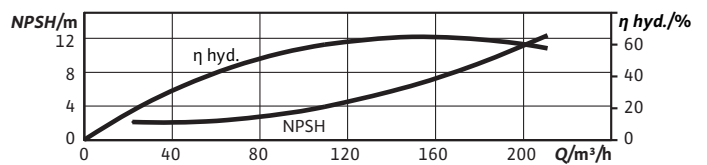
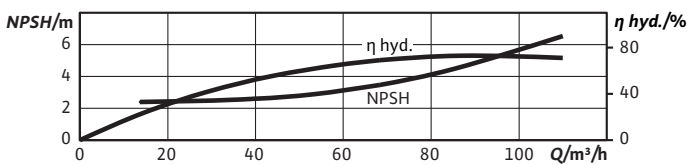
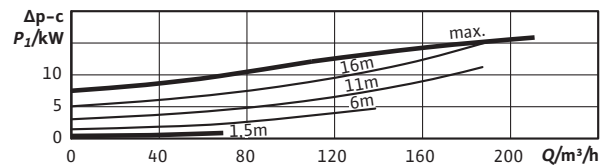
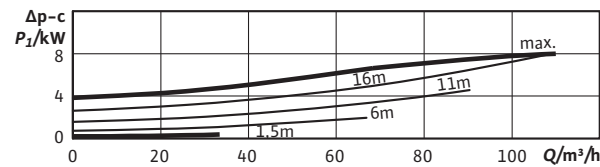
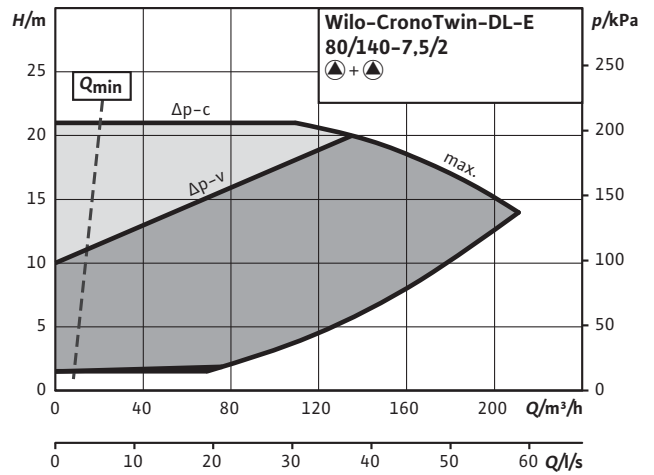
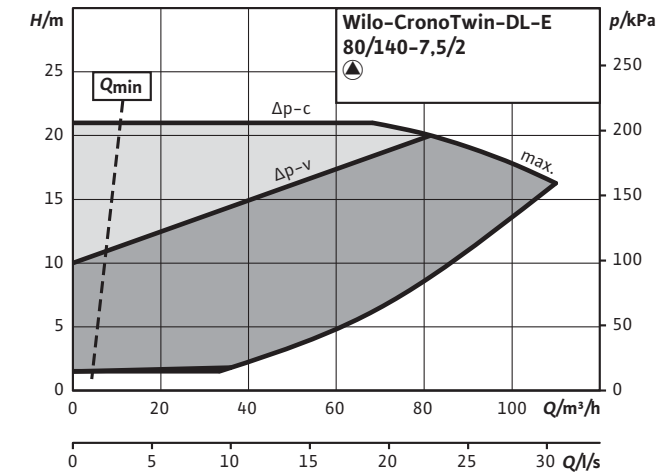
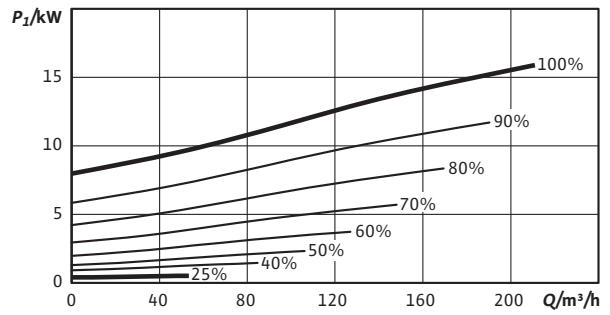
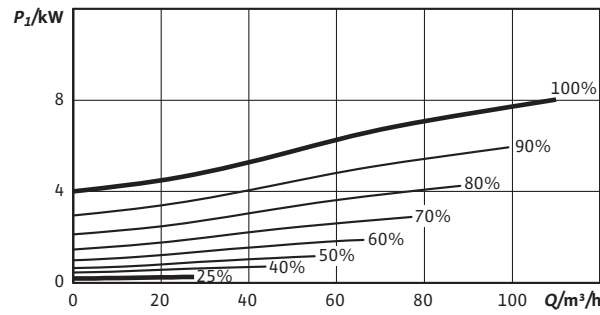
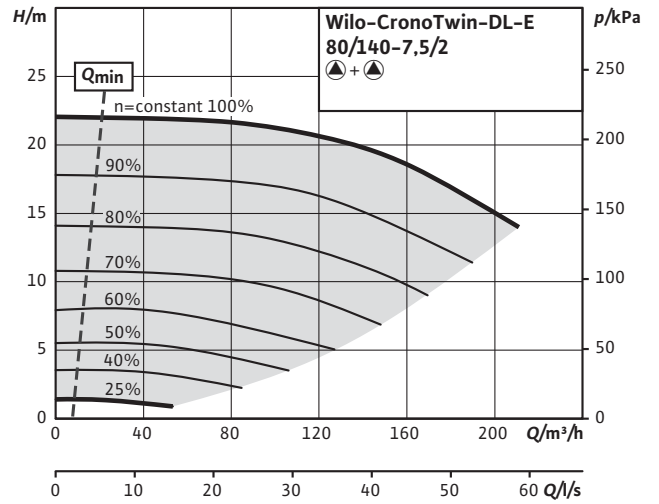
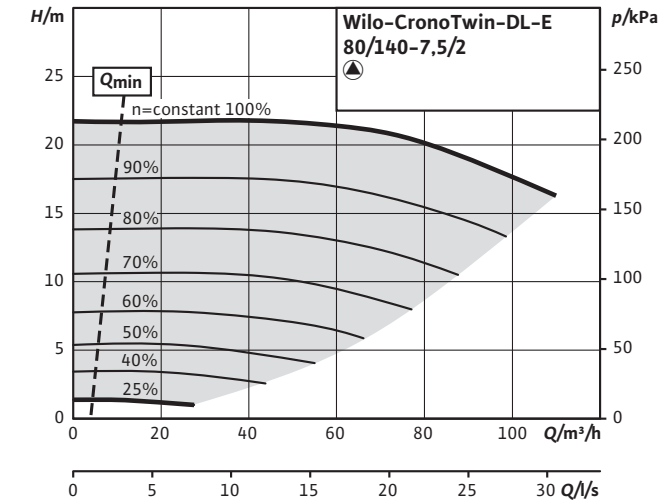

Riscaldamento, condizionamento e refrigerazione

Curve caratteristiche

CronoTwin-DL-E 80/150-7,5/2 (2 poli - funzionamento singolo)

Curve caratteristiche

CronoTwin-DL-E 80/150-7,5/2 (2 poli - funzionamento parallelo)

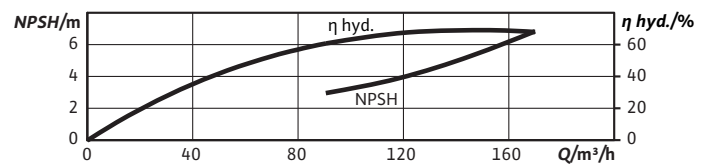
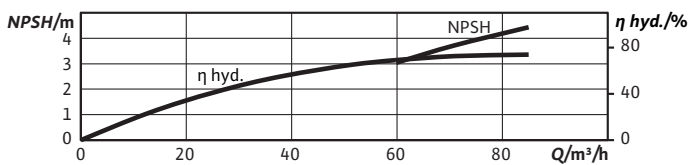
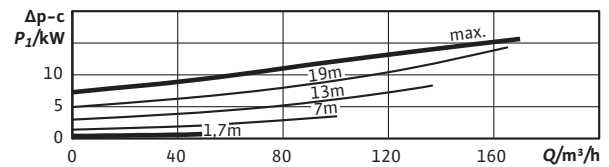
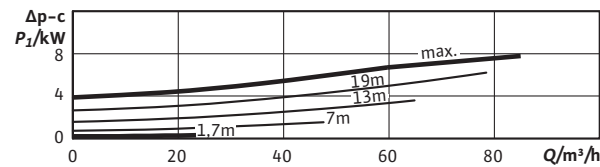
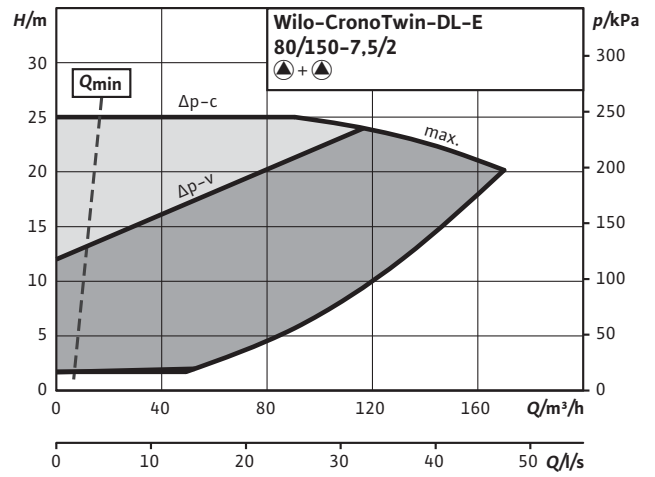
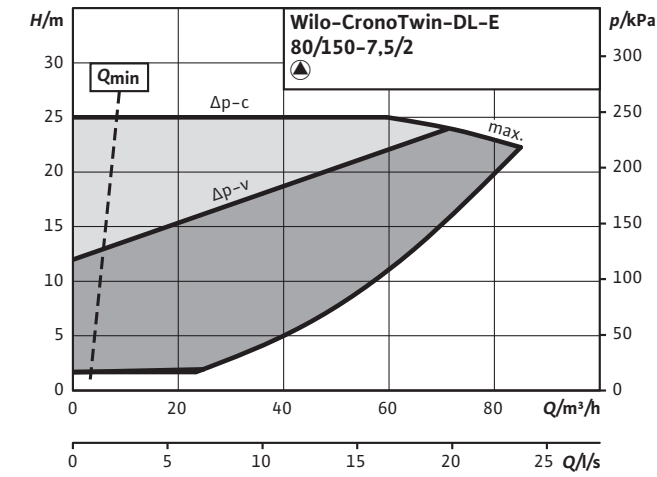
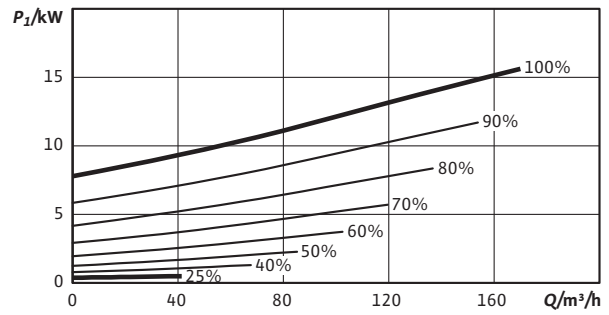
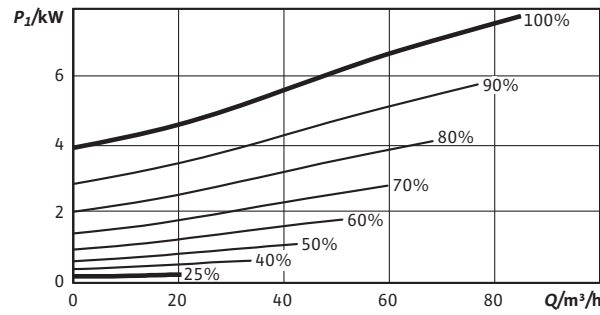
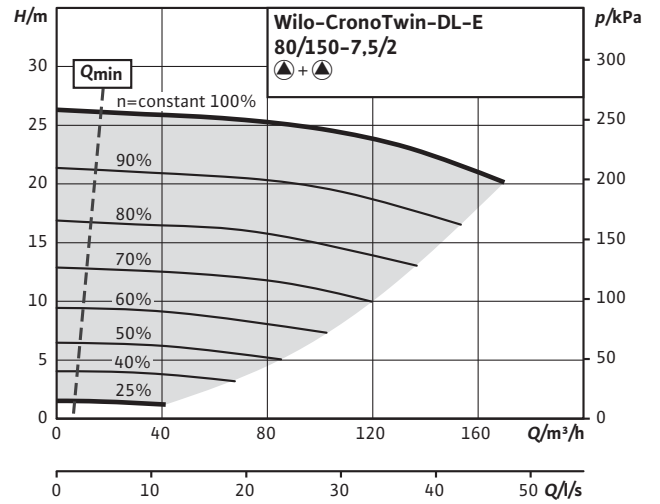
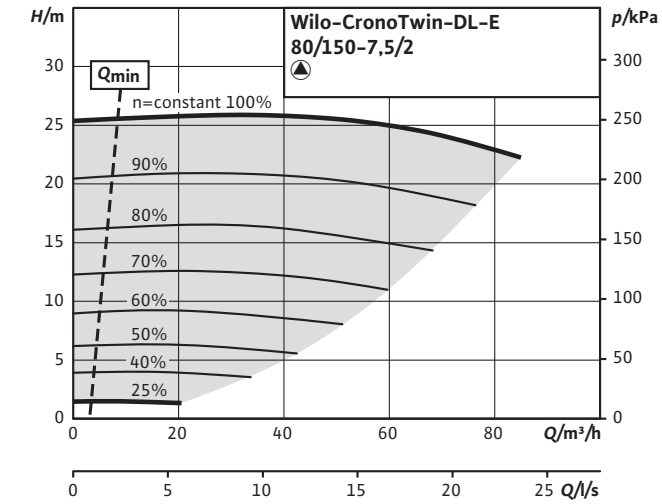

Curve caratteristiche

CronoTwin-DL-E 80/160-11/2 (2 poli - funzionamento singolo)

Curve caratteristiche

CronoTwin-DL-E 80/160-11/2 (2 poli - funzionamento parallelo)

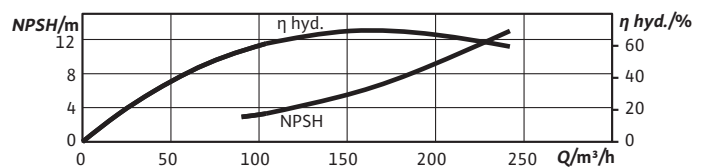
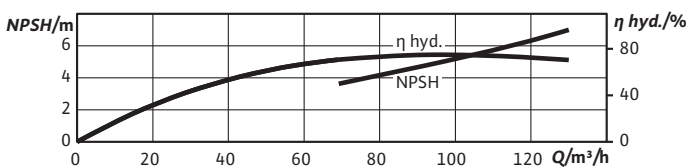
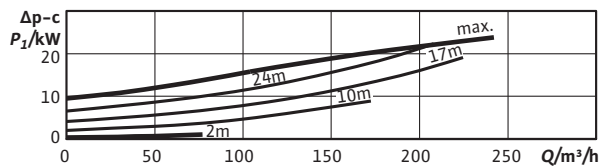
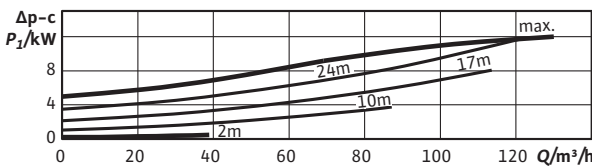
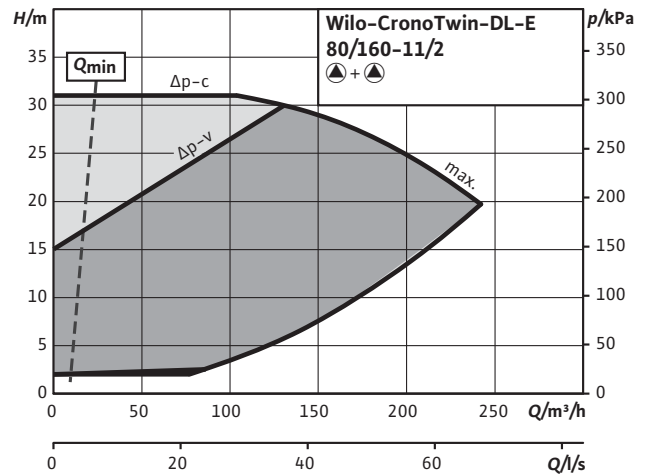
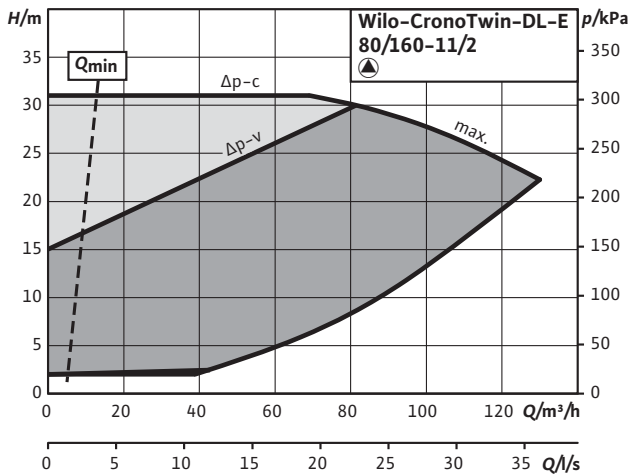
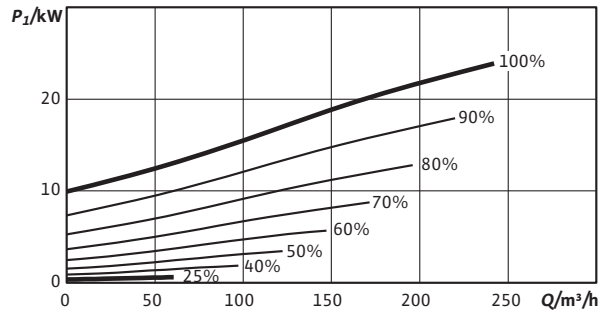
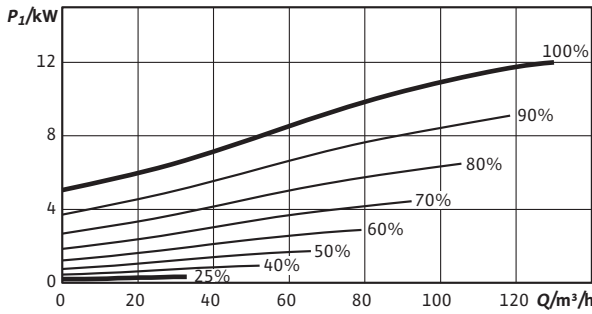
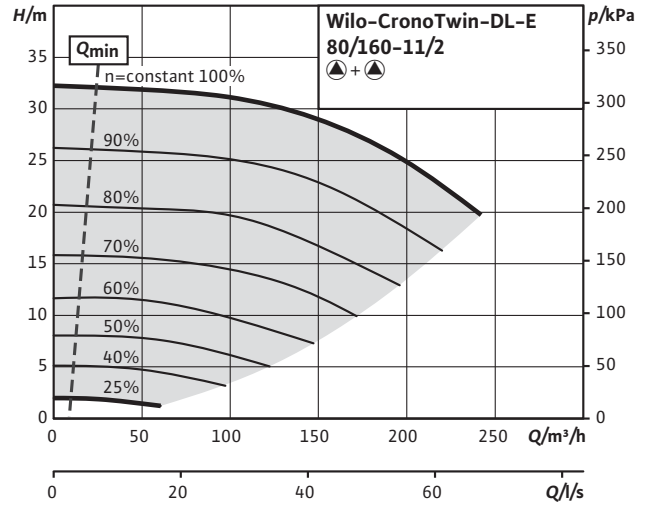
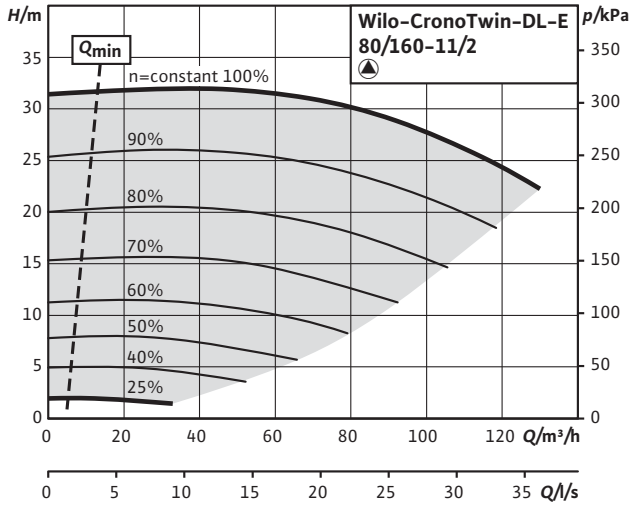

Riscaldamento, condizionamento e refrigerazione

Curve caratteristiche

CronoTwin-DL-E 80/170-15/2 (2 poli - funzionamento singolo)

Curve caratteristiche

CronoTwin-DL-E 80/170-15/2 (2 poli - funzionamento parallelo)

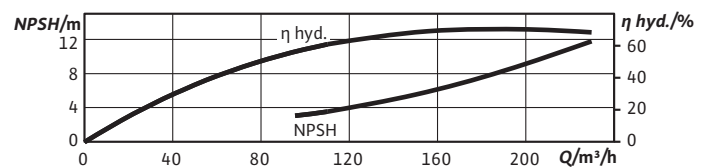
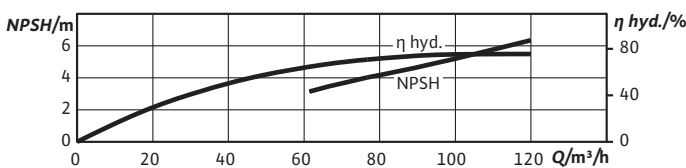
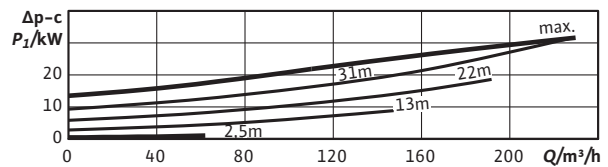
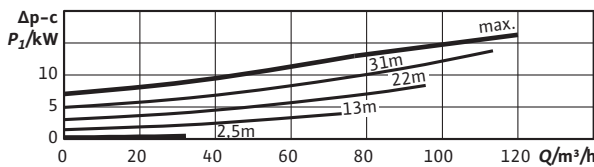
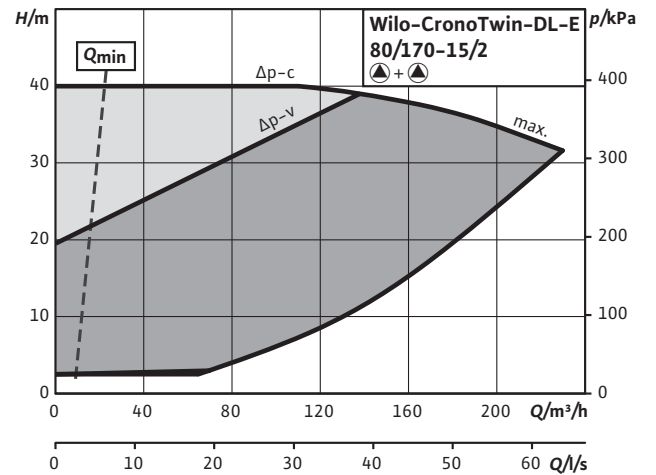
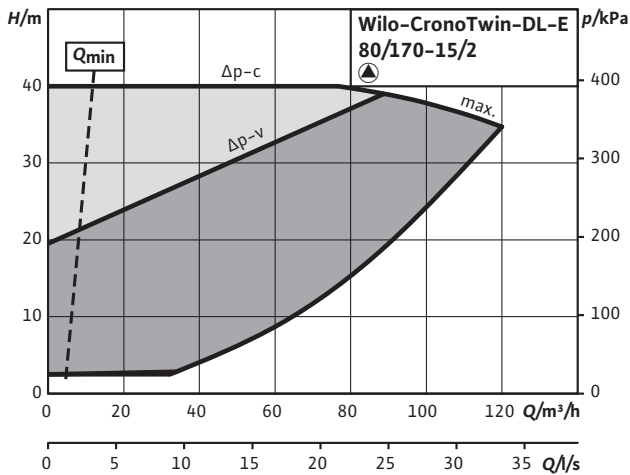
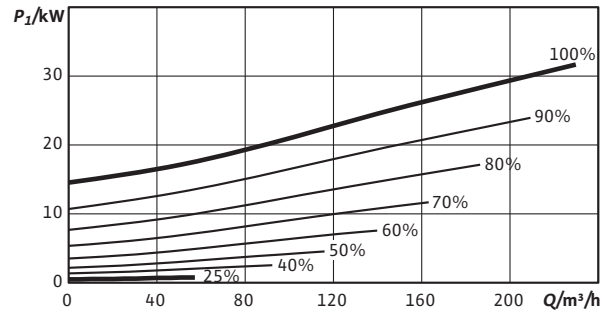
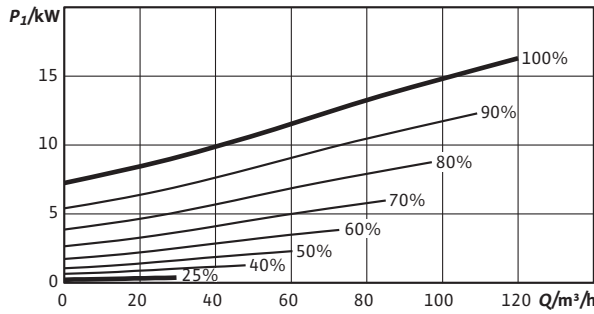
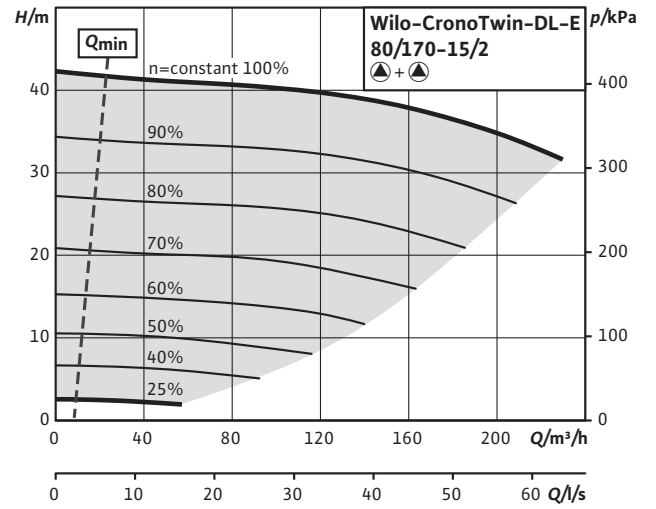
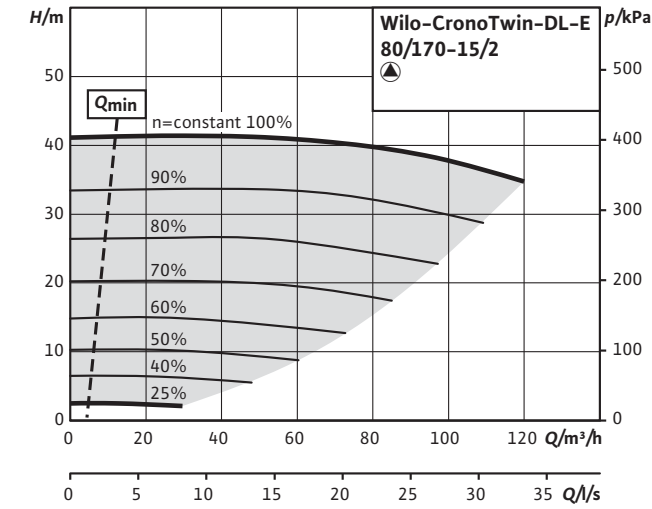



Curve caratteristiche

CronoTwin-DL-E 80/190-18,5/2 (2 poli - funzionamento singolo)

Curve caratteristiche

CronoTwin-DL-E 80/190-18,5/2 (2 poli - funzionamento parallelo)

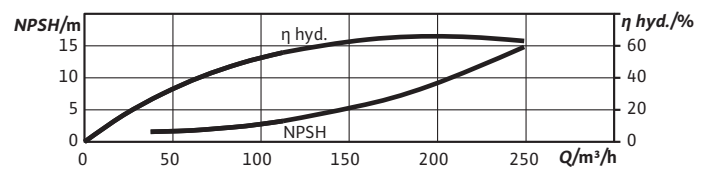
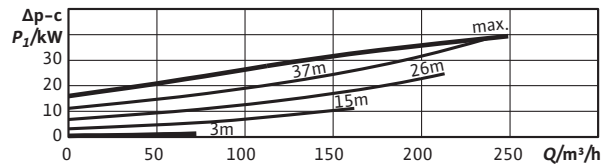
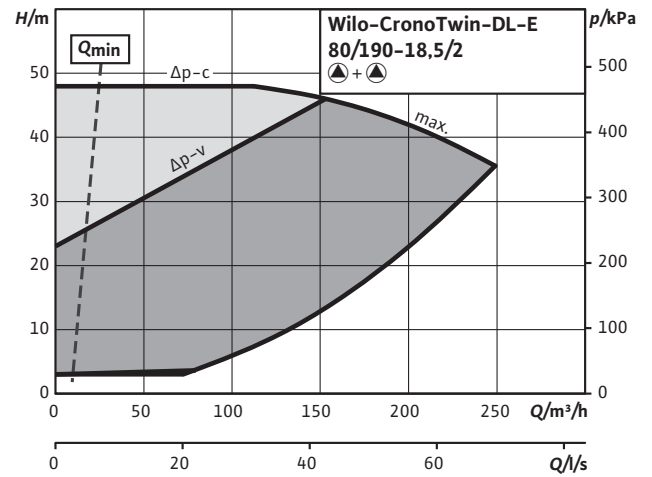
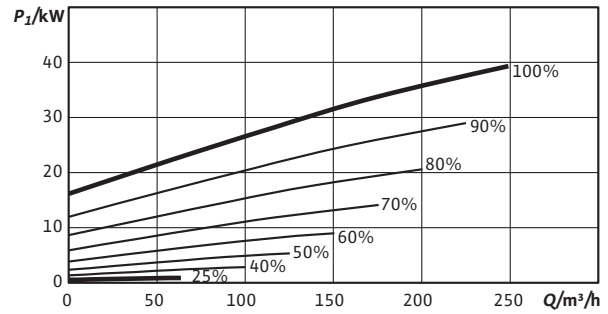
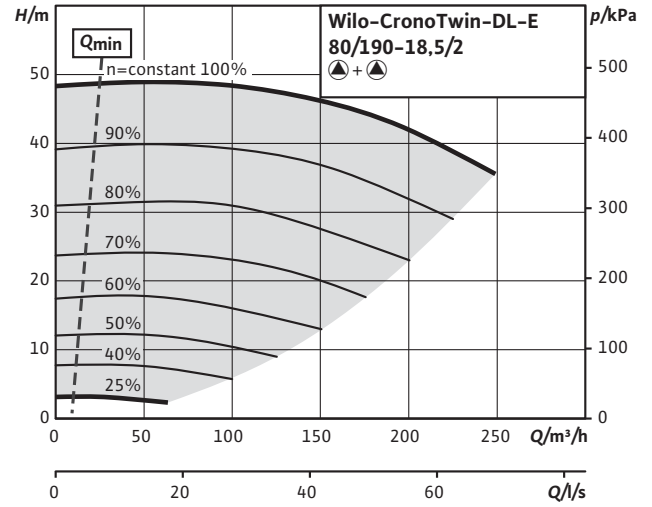
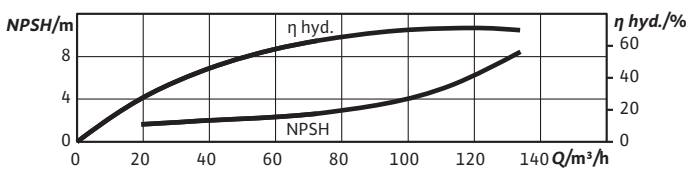
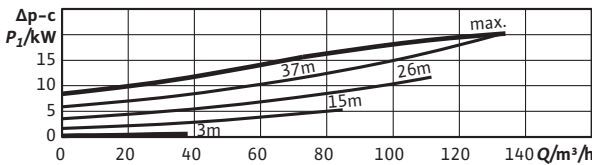
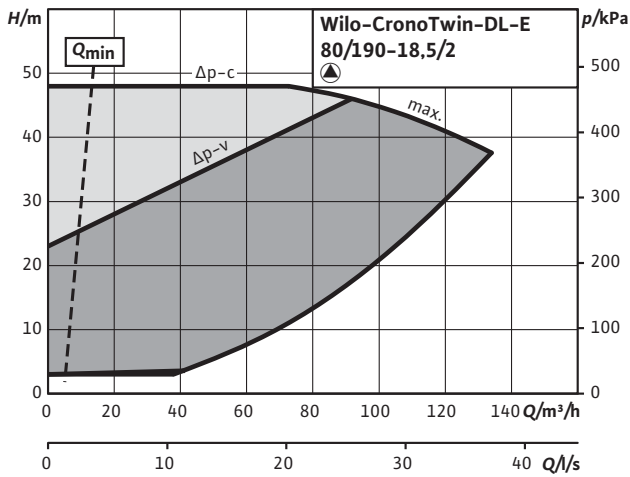
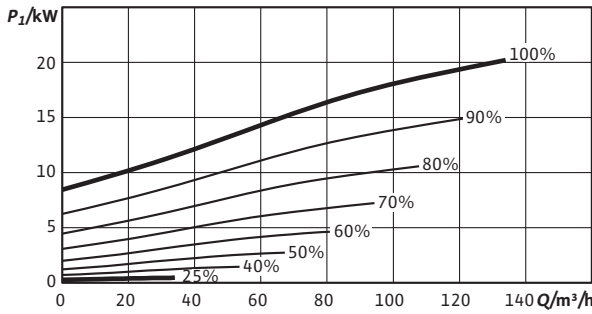
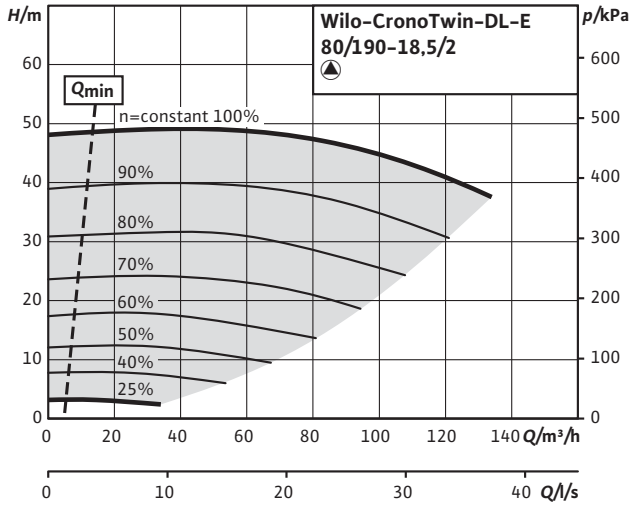

Riscaldamento, condizionamento e refrigerazione

Curve caratteristiche

CronoTwin-DL-E 80/200-22/2 (2 poli - funzionamento singolo)

Curve caratteristiche

CronoTwin-DL-E 80/200-22/2 (2 poli - funzionamento parallelo)

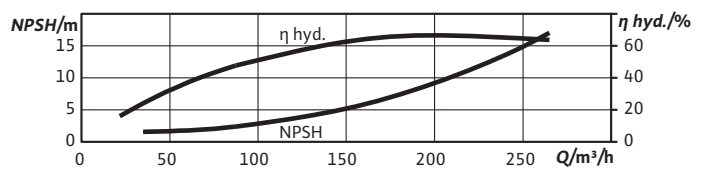
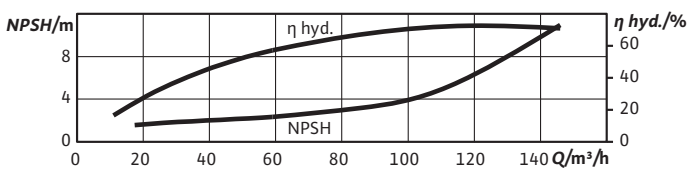
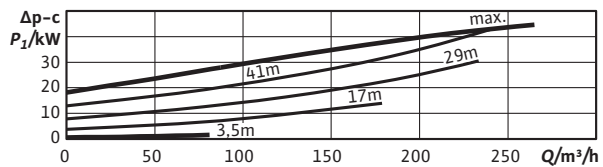
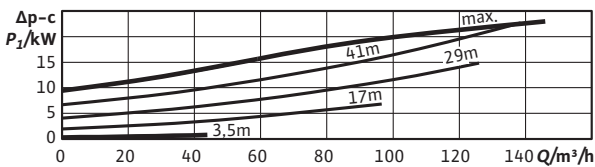
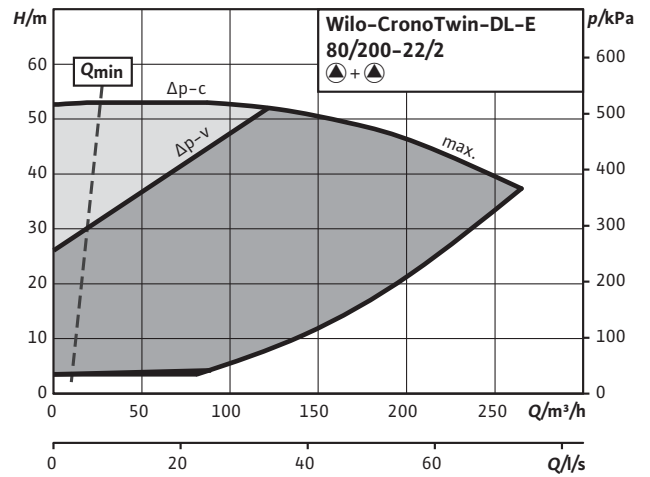
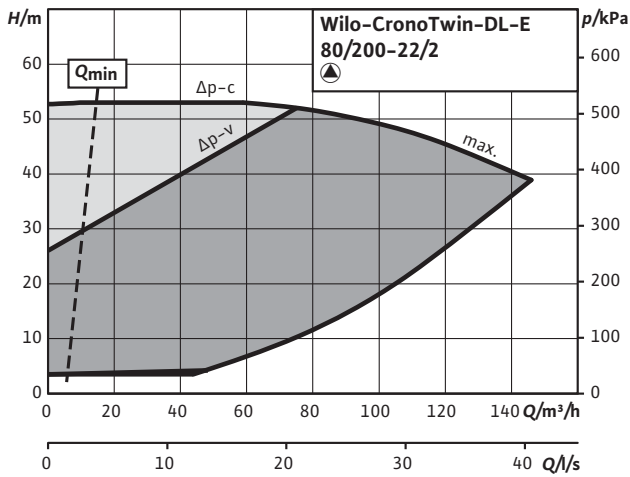
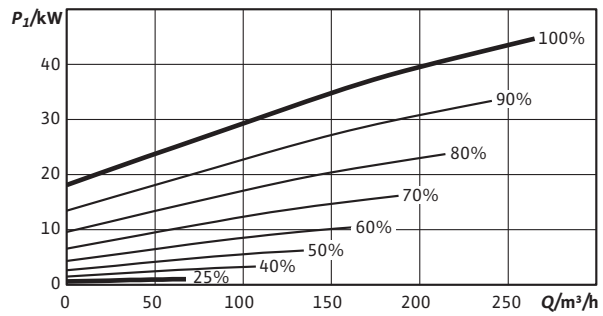
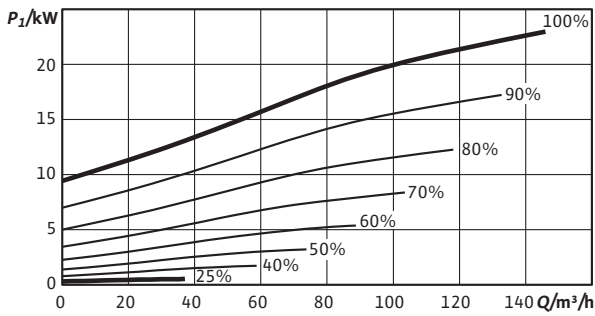
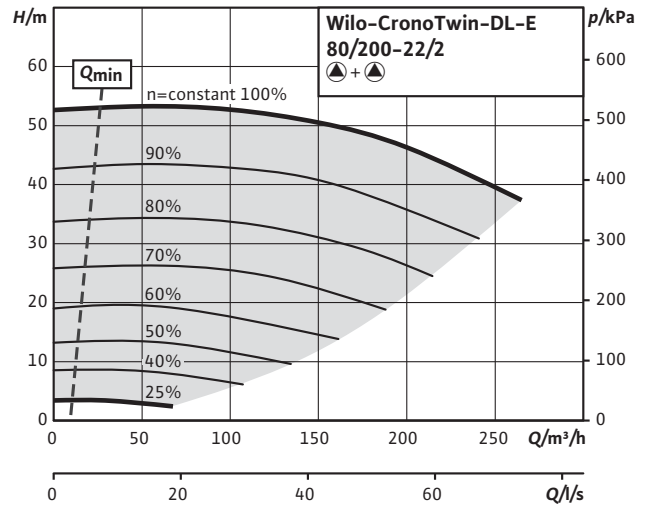
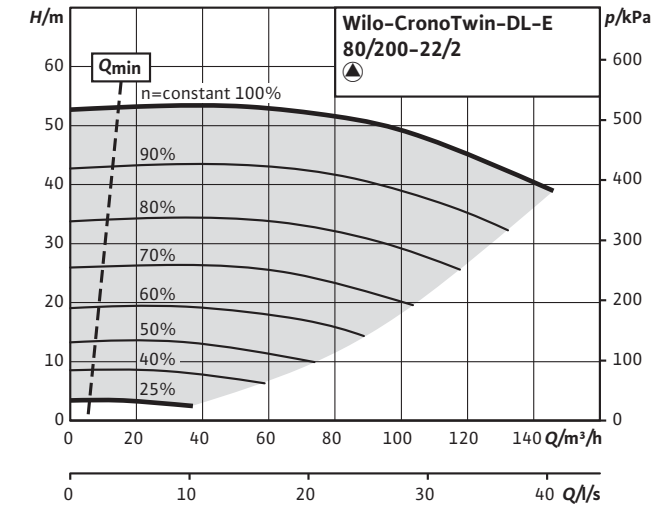

Curve caratteristiche

CronoTwin-DL-E 100/145-11/2 (2 poli - funzionamento singolo)

Curve caratteristiche

CronoTwin-DL-E 100/145-11/2 (2 poli - funzionamento parallelo)

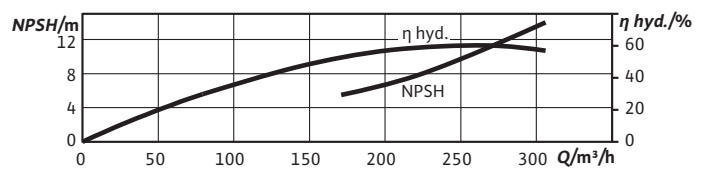
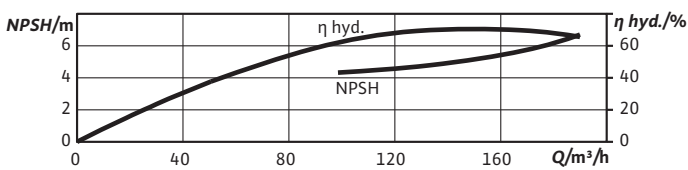
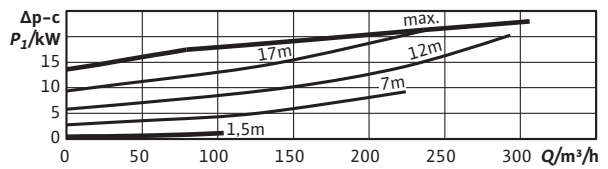
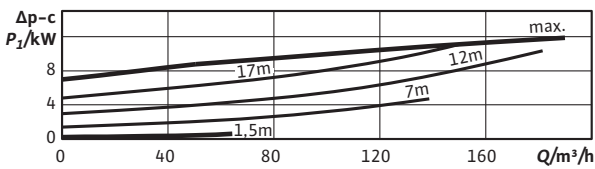
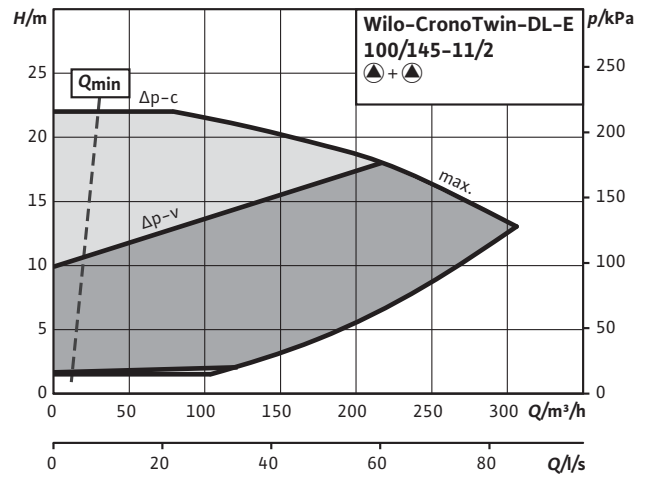
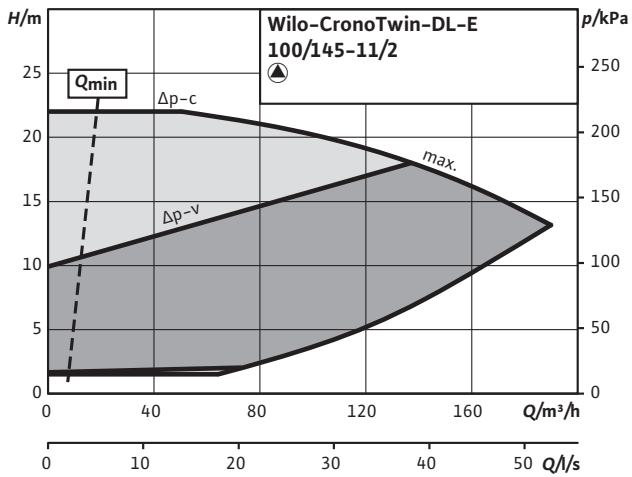
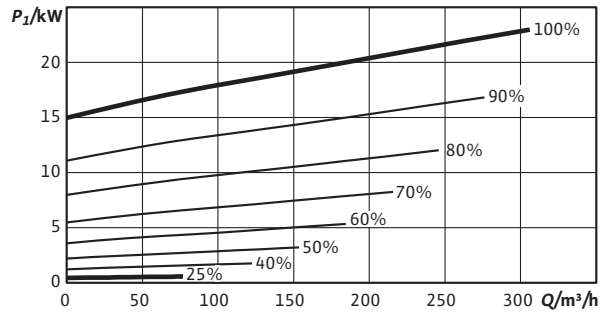
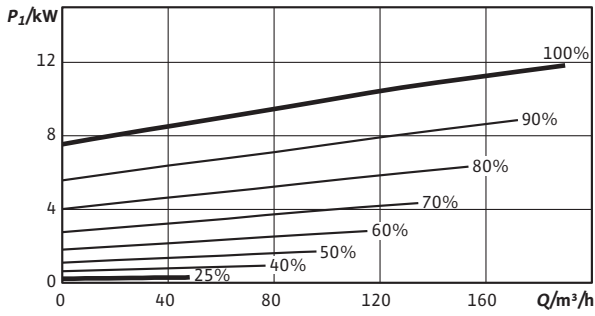
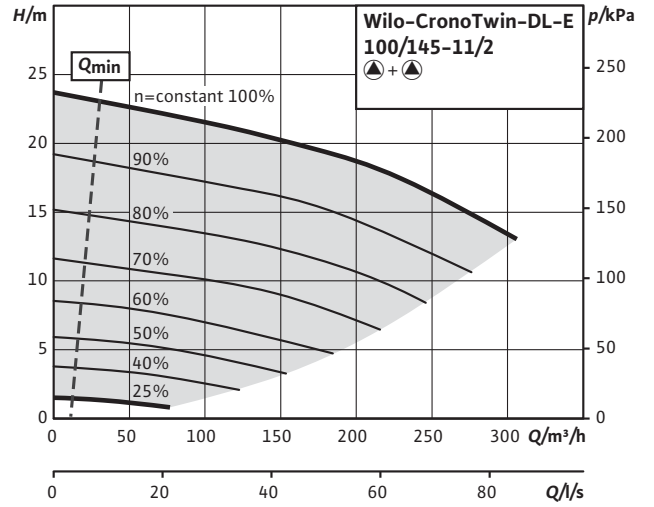
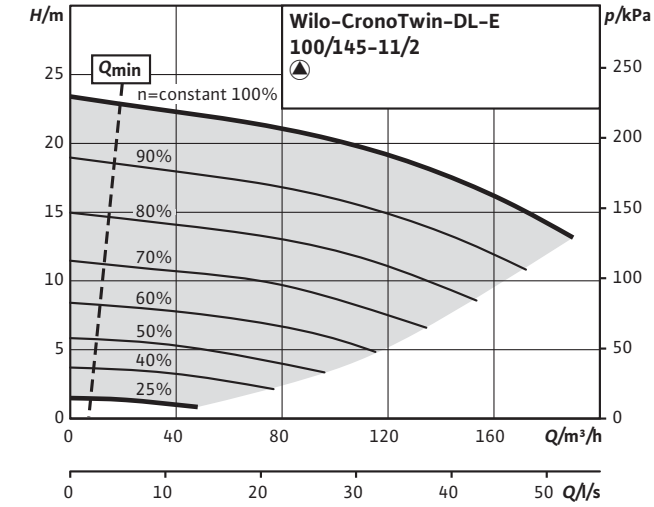

Riscaldamento, condizionamento e refrigerazione

Curve caratteristiche

CronoTwin-DL-E 100/150-15/2 (2 poli - funzionamento singolo)

Curve caratteristiche

CronoTwin-DL-E 100/150-15/2 (2 poli - funzionamento parallelo)

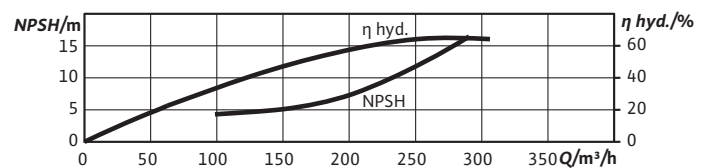
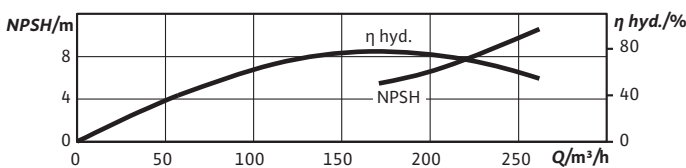
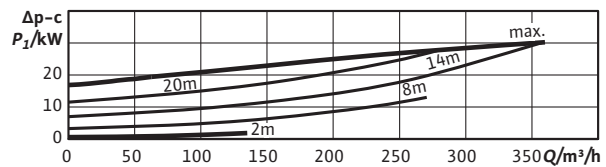
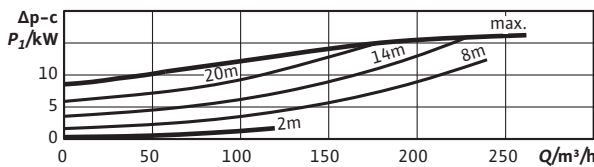
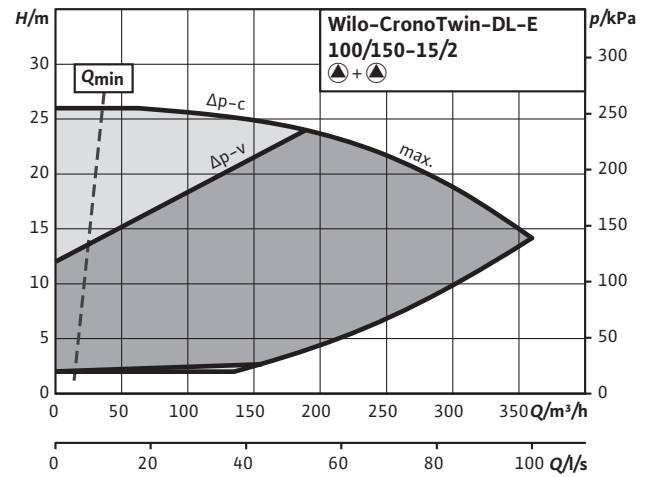
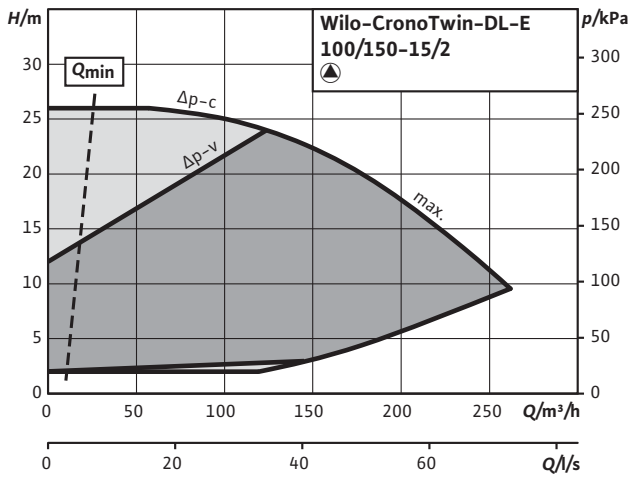
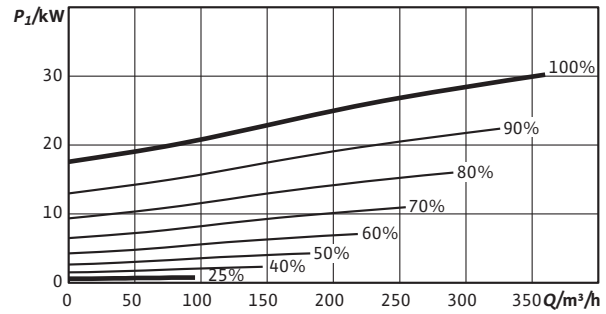
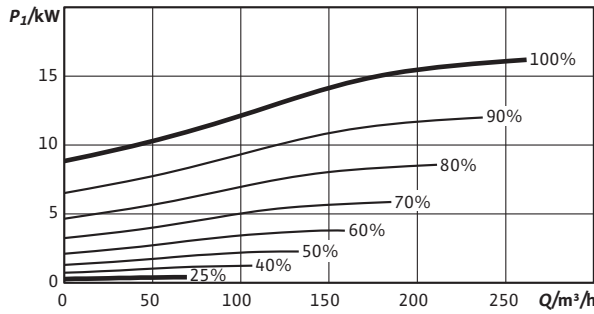
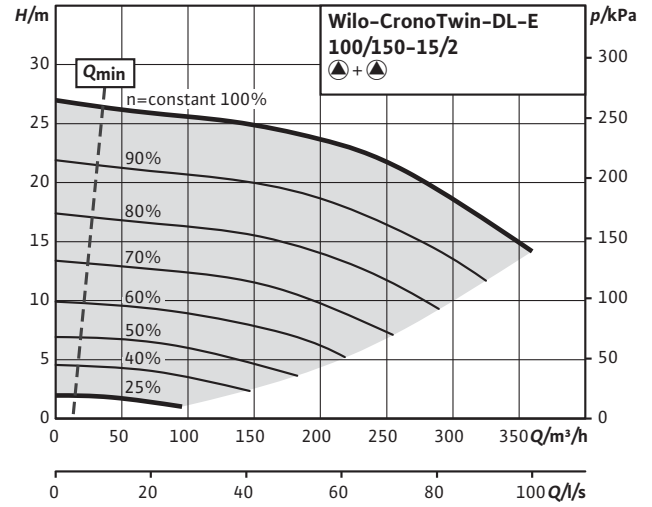
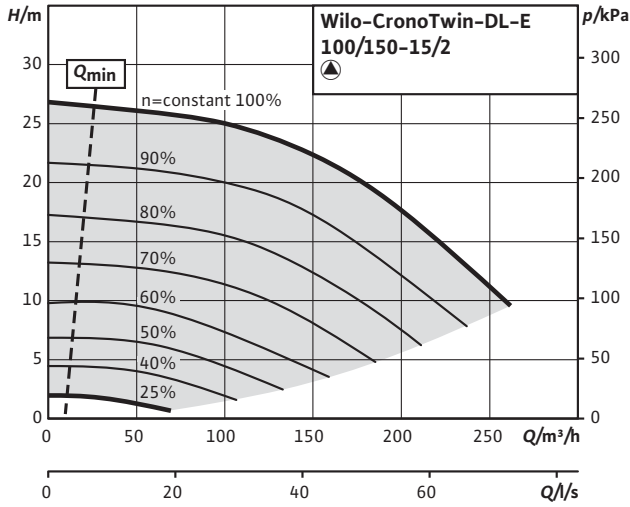

Curve caratteristiche

CronoTwin-DL-E 100/160-18,5/2 (2 poli - funzionamento singolo)

Curve caratteristiche

CronoTwin-DL-E 100/160-18,5/2 (2 poli - funzionamento parallelo)

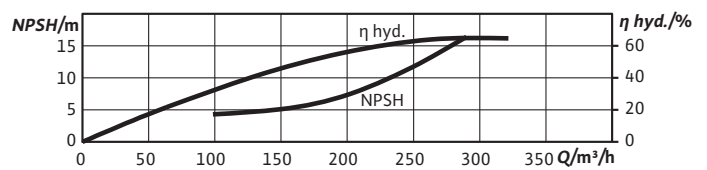
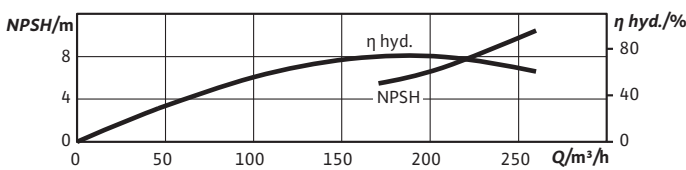
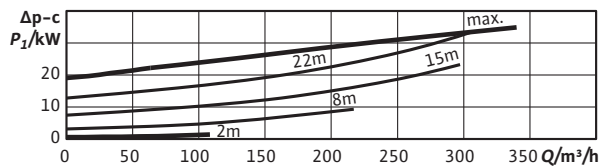
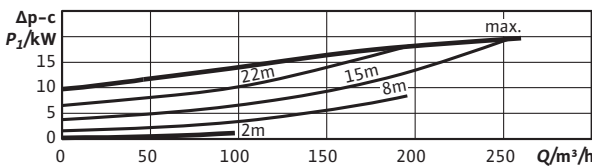
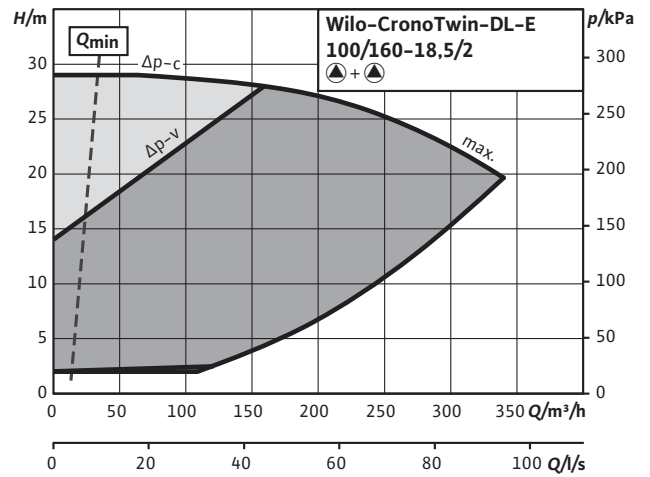
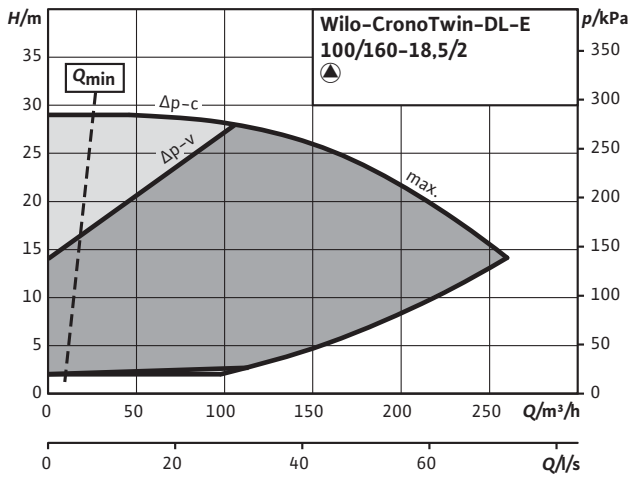
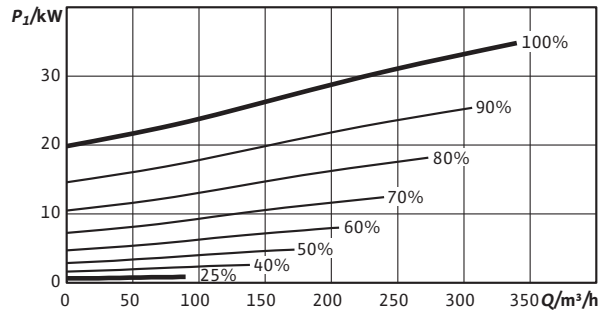
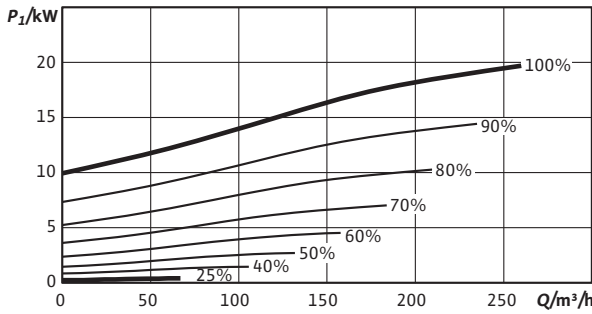
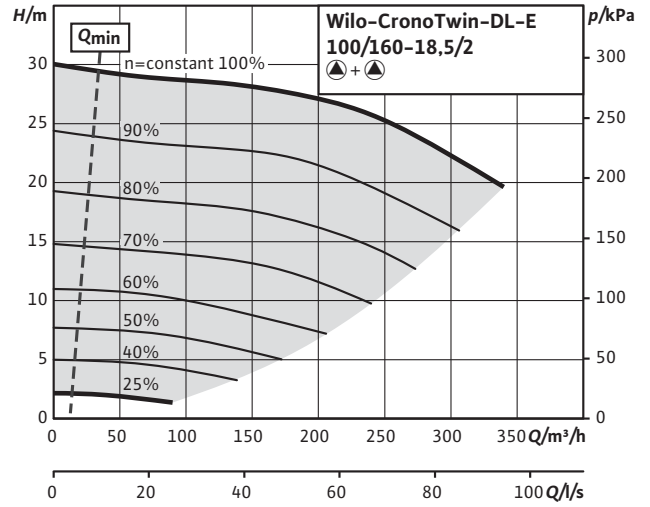
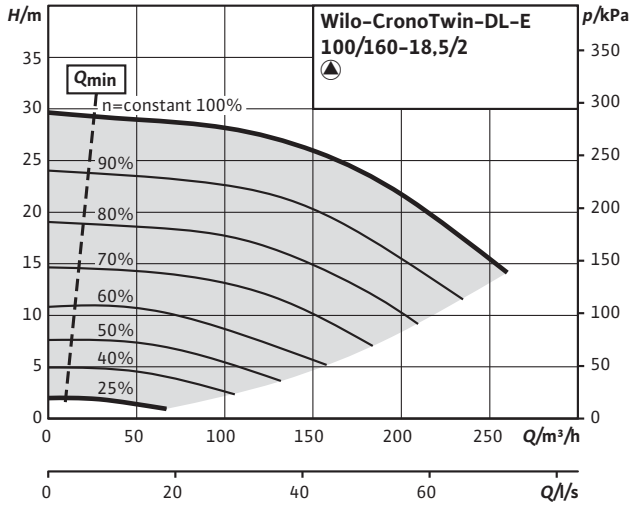

Riscaldamento, condizionamento e refrigerazione

Curve caratteristiche

CronoTwin-DL-E 100/165-22/2 (2 poli - funzionamento singolo)

Curve caratteristiche

CronoTwin-DL-E 100/165-22/2 (2 poli - funzionamento parallelo)

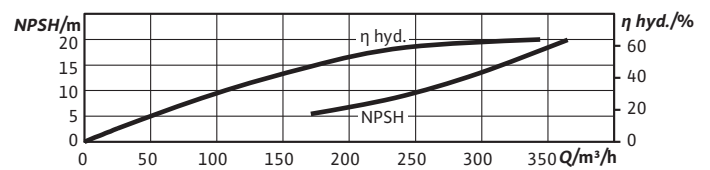
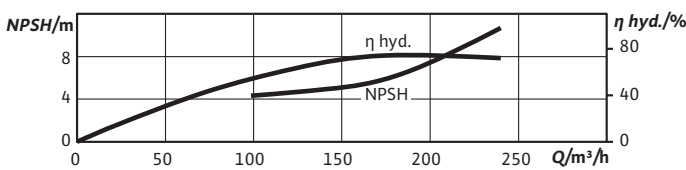
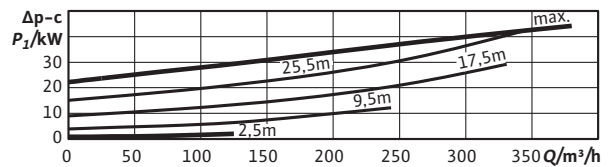
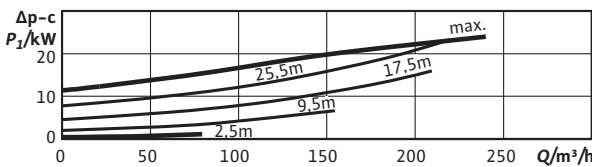
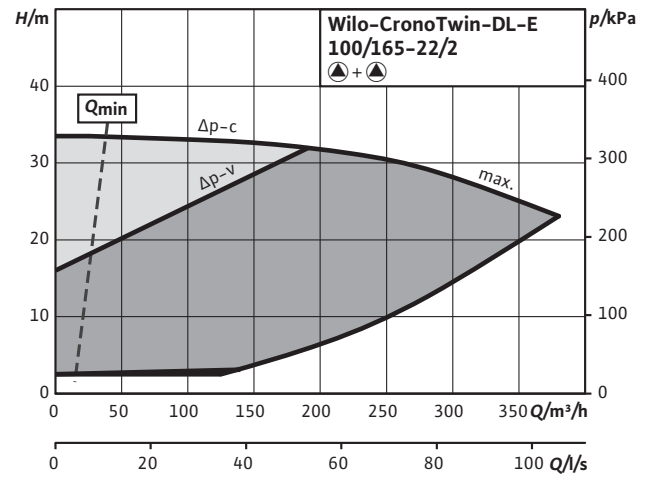
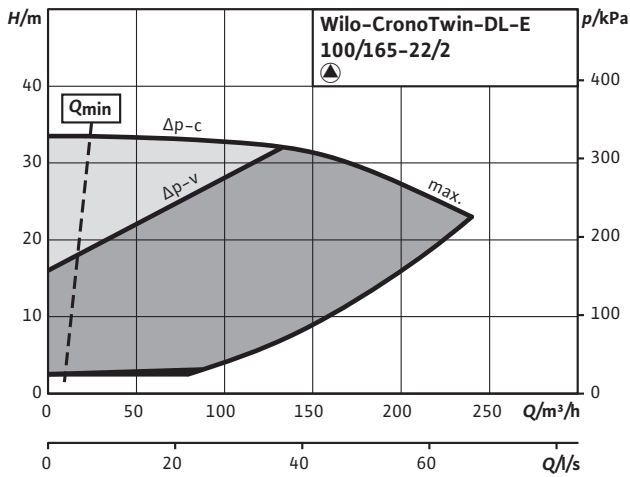
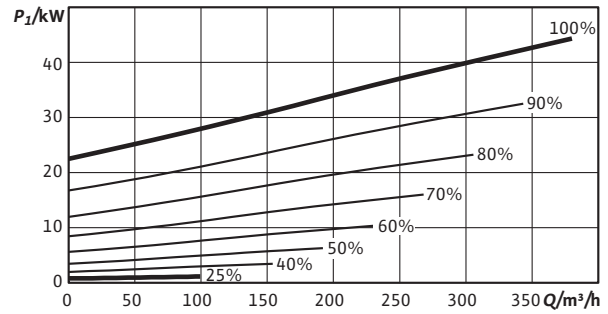
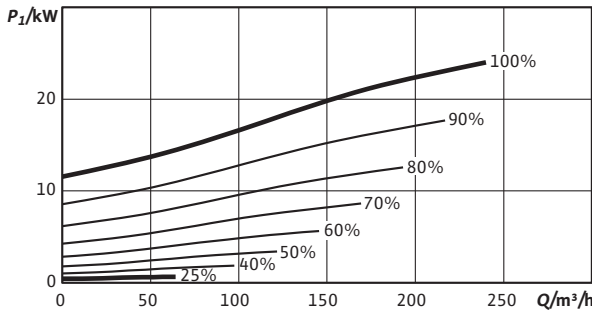
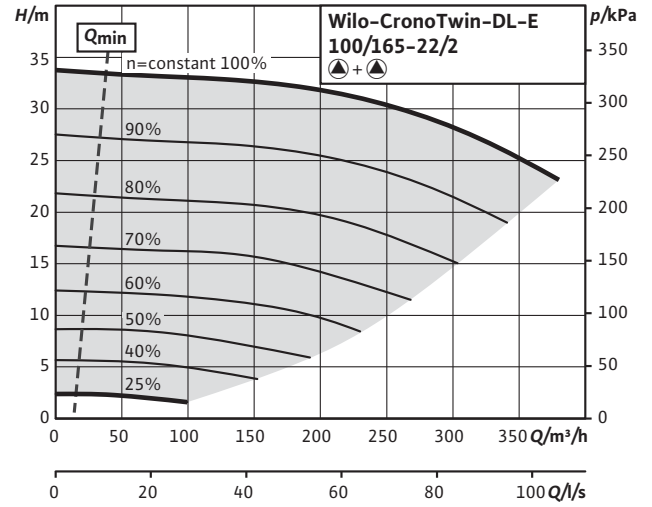
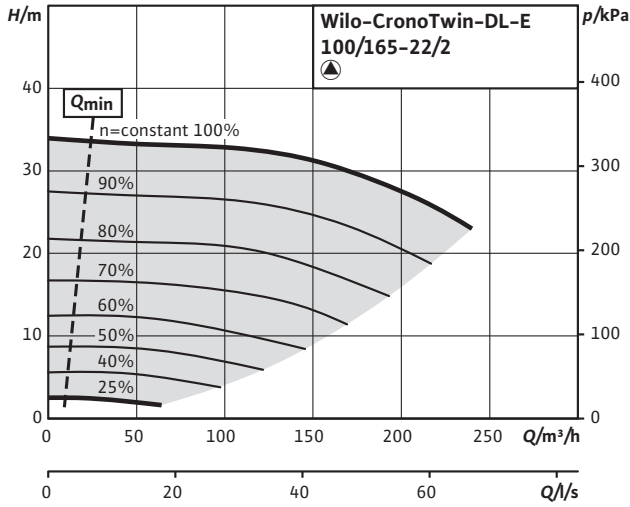



Disegno quotato

SCHEMA DIMENSIONALE A

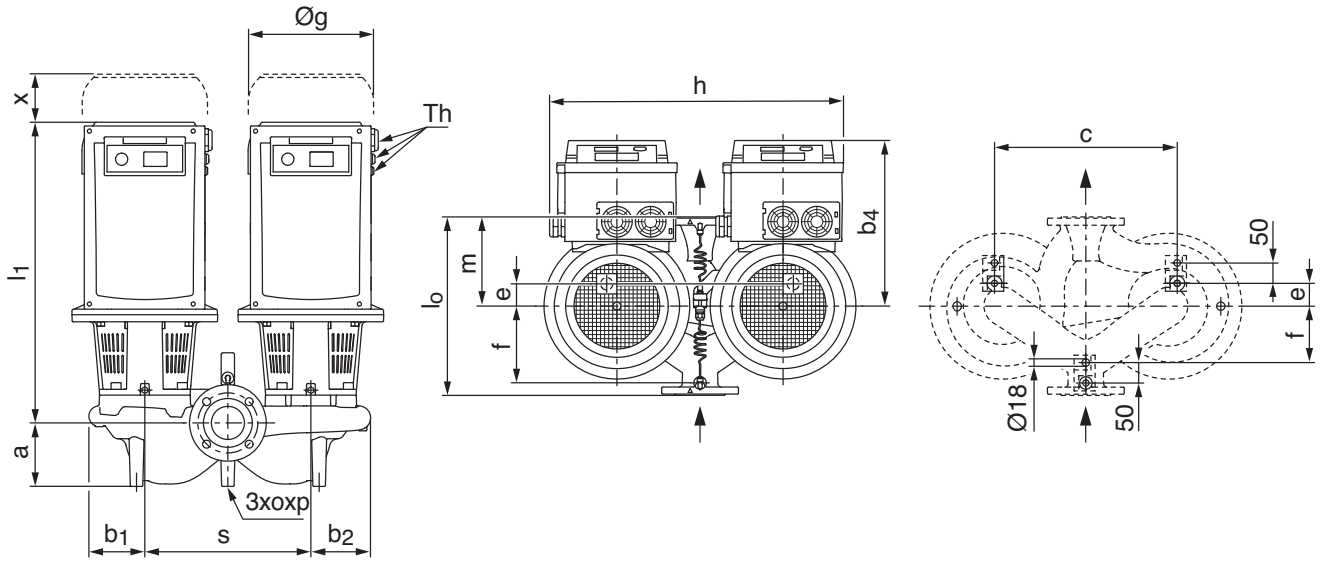

SCHEMA DIMENSIONALE B

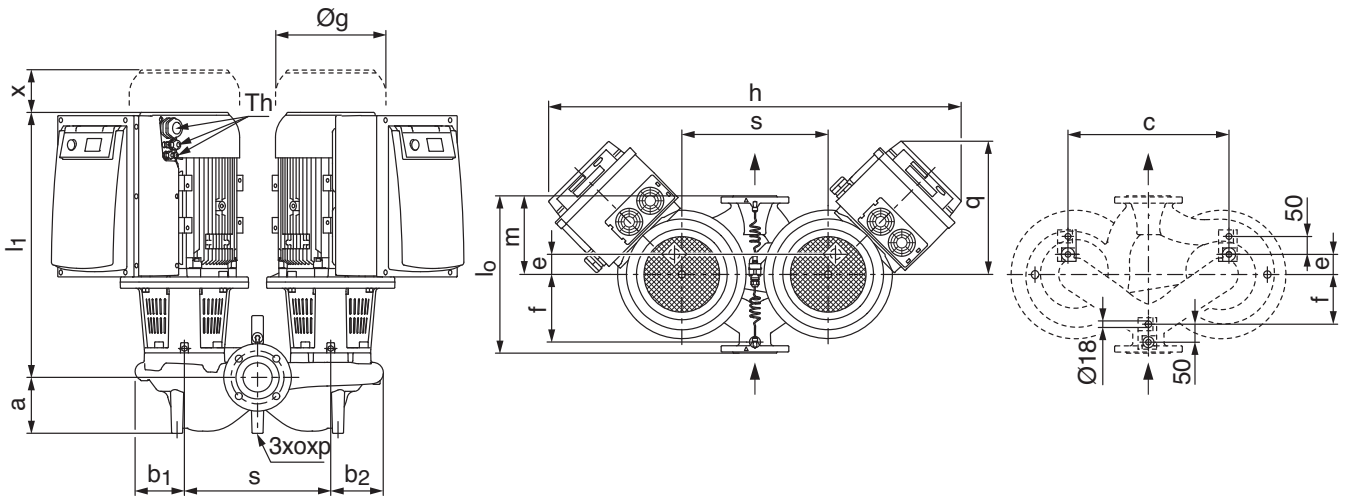

SCHEMA FLANGIE

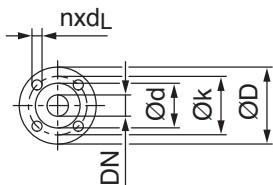

DN	Ø D	Ø k	Ø d	fori
	mm	mm	mm	n x Ø
40	150	110	84	4 x 19
50	165	125	99	4 x 19
65	185	145	118	4 x 19
80	200	160	132	8 x 19
100	220	180	156	8 x 19
125	250	210	184	8 x 19
150	285	240	211	8 x 23
200	340	295	266	12 x 23





## Moduli

### Funzioni di comando e segnalazione.

Per realizzare in maniera sempre ottimale il collegamento ai diversi sistemi di automazione degli edifici sulla base dei requisiti di oggi e del futuro, Wilo offre per tutte le pompe elettroniche moduli di interfaccia da innestare nella pompa, uno per ogni motore elettrico in funzione del protocollo di comunicazione della rete di automazione.

#### IF-BACnet

Comunicazione seriale, digitale BACnet MS/TP  
Protocollo di comunicazione "RS485".

- Trasferimento dati per il controllo e la gestione della pompa:
  - Modo di regolazione
  - Valore di consegna prevalenza/numero di giri
  - Pompa On/Off
- Trasferimento dati per le segnalazioni di stato della pompa:
  - Valore reale prevalenza
  - Valore reale consumo di energia
  - Valore reale potenza
  - Valore reale corrente motore
  - Ore di esercizio
  - Valore reale, numero di giri
  - Informazioni dettagliate sui blocchi
  - Informazioni di stato

#### IF-CAN

Comunicazione seriale, digitale CAN bus  
Protocollo di comunicazione "CAN"

- Trasferimento dati per il controllo e la gestione della pompa:
  - Modo di regolazione
  - Valore di consegna prevalenza/numero di giri
  - Pompa On/Off
- Trasferimento dati per le segnalazioni di stato della pompa:
  - Valore reale prevalenza
  - Valore reale consumo di energia
  - Valore reale potenza
  - Valore reale corrente motore
  - Ore di esercizio
  - Valore reale, numero di giri
  - Informazioni dettagliate sui blocchi
  - Informazioni di stato





## IF-Modbus

Comunicazione seriale, digitale Modbus RTU  
Protocollo di comunicazione "RS485".

- Trasferimento dati per il controllo e la gestione della pompa:
  - Modo di regolazione
  - Valore di consegna prevalenza/numero di giri
  - Pompa On/Off
- Trasferimento dati per le segnalazioni di stato della pompa:
  - Valore reale prevalenza
  - Valore reale consumo di energia
  - Valore reale potenza
  - Valore reale corrente motore
  - Ore di esercizio
  - Valore reale, numero di giri
  - Informazioni dettagliate sui blocchi
  - Informazioni di stato

## IF-LON

Comunicazione seriale, digitale LON  
Protocollo di comunicazione "LONWORKS".

- Trasferimento dati per il controllo e la gestione della pompa:
  - Modo di regolazione
  - Valore di consegna prevalenza/numero di giri
  - Pompa On/Off
  - Dati di sensori esterni
- Trasferimento dati per le segnalazioni di stato della pompa:
  - Valore reale prevalenza
  - Valore reale consumo di energia
  - Valore reale potenza
  - Valore reale corrente motore
  - Ore di esercizio
  - Valore reale, numero di giri
  - Informazioni dettagliate sui blocchi
  - Informazione di stato

## IF-PLR

Comunicazione seriale, digitale PLR  
Protocollo di comunicazione "WILO".

- Trasferimento dati per il controllo e la gestione della pompa:
  - Modo di regolazione
  - Valore di consegna prevalenza/numero di giri
  - Pompa On/Off
- Trasferimento dati per le segnalazioni di stato della pompa:
  - Valore reale prevalenza
  - Valore reale consumo di energia
  - Valore reale potenza
  - Valore reale corrente motore
  - Ore di esercizio
  - Valore reale, numero di giri
  - Informazioni dettagliate sui blocchi
  - Informazione di stato

## Wilo-Moduli IF

### L'integrazione efficace ai sistemi BMS.

I moduli IF permettono di integrare le pompe in-line a motore ventilato elettroniche Wilo-Veroline e Wilo-Cronoline in tutti i sistemi di Building Management System secondo i più diffusi parametri di comunicazione.

La gestione e il controllo della pompa grazie alle interfacce WILO-Modulo IF, è completa, dal sistema di supervisione si accede a tutti i parametri di funzionamento, si può gestire e controllare la pompa durante il suo ciclo di funzionamento.

L'integrazione nei sistemi BMS Delle pompe serie Wilo-Veroline e Wilo-Cronoline può avvenire sia in fase di installazione che successivamente, le Interfacce possono essere installate in qualsiasi momento e sono disponibili per comunicare con i più diffusi sistemi di integrazione:

- ✓ Lonworks
- ✓ Modbus
- ✓ Canbus
- ✓ Bacnet



I Moduli IF WILO rendono possibili i servizi di comunicazione e gestione, secondo gli standard previsti dalla direttiva VDI 3814.

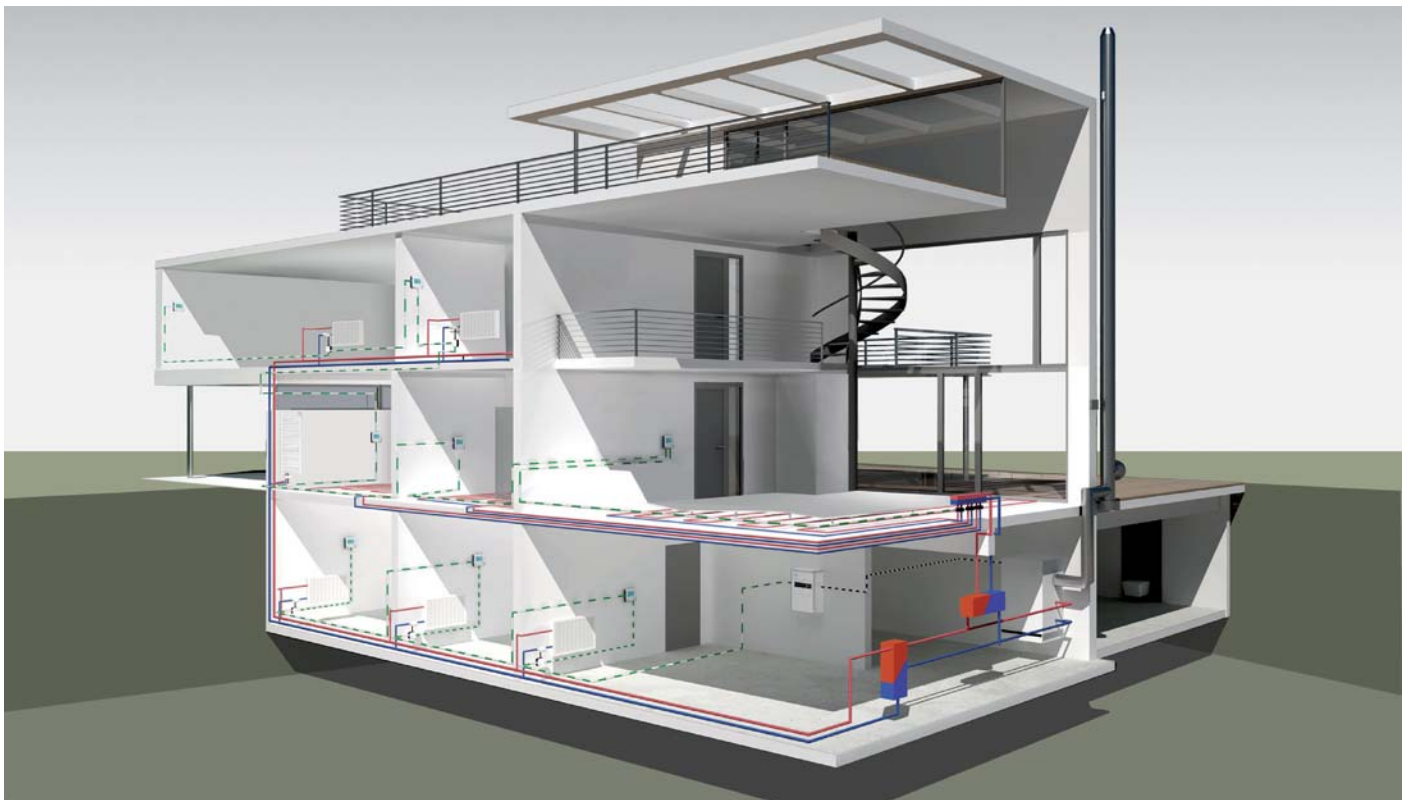

## → Wilo-IR Stick

### Applicazioni:

Il PC diventa uno strumento di servizio per pompe con il **Wilo-IR Stick**.

Gli scambi di informazioni tra le pompe Wilo e il Servizio Wilo Tool Software è fatto in modalità wireless tramite la chiavetta USB, compatibile con tutte le pompe a regolazione elettronica esistenti con interfaccia ad infrarossi.



## Wilo-IR Stick

Dispositivo compatibile con tutte le porte USB che permette, grazie alla sua interfaccia ad infrarossi, la gestione e il controllo delle pompe Wilo a velocità variabile. Il suo utilizzo consente di:

### Accedere a tutti i parametri di regolazione della pompa

- $\Delta P-V$
- $\Delta P-C$
- Regolazione della velocità
- Funzione Rallenty
- Visualizzazione del punto di lavoro sulla curva caratteristica
- Impostazione ciclo di scambio pompa (Master slave) per modelli gemellari Stratos-D o 2 Sstratos singoli collegati con moduli IF
- Impostazione segnalazione di tipo SSM

### Accesso al registro di funzionamento dei parametri della pompa

- Consumo elettrico istantaneo e cumulativo
- Statistiche di funzionamento relative al carico di lavoro effettivo
- Temperatura del fluido
- Punto di lavoro reale sulla curva caratteristica
- Statistiche errori e anomalie
- Auto test della pompa (Modulo elettronico, Motore elettrico e Idraulica)

**Report (documenti stampabili) personalizzati sullo stato di funzionamento della pompa per semplificare le operazioni di manutenzione e controllo.**

Caratteristiche prestazionali			
	Apparecchio di regolazione Wilo...		
	VR-HVAC	SCe-HVAC	CCe-HVAC
<b>Dati tecnici</b>			
Numero pompe	1-4	1-4	1-6
Campo potenza nominale $P_2$	0,37-22,0 kW	0,55-22 kW	0,37-22,0 kW
Alimentazione elettrica	3 ~ 400 V, 50/60 Hz	3 ~ 400 V, 50/60 Hz	3 ~ 400 V, 50/60 Hz
Indice di protezione	IP 54	IP 54	IP 54
Temperatura ambiente consentita	da 0 °C fino a +40 °C	da 0 °C fino a +40 °C	da 0 °C fino a +40 °C
Gamma di regolazione	Analogico progressivo, 2/4-10 V preselezionabile, velocità min. pompa secondo targhetta fino a 100 %	tra 30 % e 100 % della velocità nominale del motore	Analogico progressivo, 2/4-10 V preselezionabile, velocità min. pompa secondo targhetta fino a 100 %
<b>Modo di regolazione</b> (descrizione vedi pagine seguenti)			
$\Delta p-c$	Si	Si	Si
$\Delta p-c$ (TA)	No	No	Si
$\Delta p-q$ (m <sup>3</sup> /h)	No	No	Si
$\Delta p-v$	Si	Si	Si
$T_A$ (temperatura esterna)	No	Si (servomotore)	Si (servomotore)
$T-abs$ (temp. processo.)	No	Si (servomotore)	Si (servomotore)
$T_{VL}$ (temperatura mandata)	No	Si (servomotore)	Si (servomotore)
$T_{RL}$ (temperatura ritorno)	No	Si	Si
$\Delta T-c$	No	Si	Si
$\Delta T-v$	No	No	Si
Modo di servomotore (DDC)	No	Si	Si
Q-c	No	No	Si
<b>Funzioni di comando e segnalazione</b>			
Impostazione remota della velocità	No	0/4 - 20 mA (di serie) 0/2 - 10 V (opz. su richiesta)	0/4 - 20 mA (di serie) 0/2 - 10 V (opz. su richiesta)
Impostazione a remota del valore di consegna	No	0/4 - 20 mA (di serie) 0/2 - 10 V (opz. su richiesta)	0/4 - 20 mA (di serie) 0/2 - 10 V (opz. su richiesta)
Visualizzazione funzionamento e segnalazione guasto	Si	Si	Si
Ingresso di comando "Prioritario Off"	Si	Si	Si
SBM /SSM	Si	Si	Si
Commutazione dalla pompa base a quella di riserva in caso di blocco	Si	Si	Si
Indicazione degli stati di funzionamento delle pompe e conv. di frequenza	No	Si	Si
<b>Funzioni disponibili</b>			
Display grafico	Guidato da menù/ visualizzazione con simboli	Guidato da menù/ visualizzazione con simboli	Guidato da menù/ visualizzazione con testi e con simboli
Livello di comando	Manuale /0 /Auto	Manuale /0 /Auto	Manuale /0 /Auto
Memoria errori	9 segnalazioni	16 segnalazioni	35 segnalazioni
Scambio pompe per blocco	Si	Si	Si
Impulso avviamento pompa	Si	Si	Si
Ottimizzazione tempi di funz. /Scambio ciclico pompe	solo scambio pompe ciclico in base al tempo	Si	Si
Regolatore PID	Si	Si	Si
Contaore di servizio integrato con conteggio singolo/cumulativo	Si	Si	Si
Ottimizzazione dei periodi di funzionamento per i sistemi a più pompe	No	Si	Si
Commutazione sul secondo valore di consegna	No	Si	Si (max. 3)



### Particolarità/vantaggi del prodotto

#### Modi di regolazione

- Regolazione costante della pressione differenziale ( $\Delta p-c$ )
- Regolazione variabile della pressione differenziale ( $\Delta p-v$ )

#### Gestione

- Fino a 4 pompe singole o 2 pompe gemellari
- Gestione pompa di riserva
- Funzionamento in somma di portata ed alternanza automatica delle pompe

## Wilo-Sistema VR-HVAC

### Tipo

→ per impianti a pompa singola e a più pompe fino a 4 pompe complessive (4 motori elettrici) es. 4 pompe singole "IP-E/IL-E" o 2 pompe gemellari "DP-E/DL-E".

→ **Le pompe devono essere tutte dello stesso modello**

→ Modo di regolazione:

- Pressione differenziale - costante ( $\Delta p-c$ )
- Pressione differenziale - variabile ( $\Delta p-v$ )

### Funzioni disponibili

- Interruttore principale bloccoporta
- Regolatore PID
- Display Grafico LCD per la visualizzazione di tutti i valori e gli stati di esercizio
- Tecnologia del pulsante rosso
- LED per la segnalazione dello stato di esercizio, pompa(e) in uso, pompa(e) in blocco
- Interruttori di protezione e morsetti di uscita per l'alimentazione delle pompe
- Scambio automatico delle pompe
- Possibilità di funzionamento in emergenza
- Selezione della pompa di riserva
- Scheda segnalazioni integrata (opzionale)

### Funzioni di comando e segnalazione remota

Il sistema Wilo-VR-HVAC dispone di serie di molteplici ingressi e uscite di comando:

- Uscita analogica  $\Delta p_{out}$  (0 - 10 VDC) per l'emissione del valore reale fornito dal trasduttore di pressione differenziale
- Contatti liberi da potenziale:
  - Inserimento/disinserimento pompa
  - Segnalazione cumulativa di blocco
  - Segnalazione cumulativa di funzionamento
  - Segnalazione singola di blocco ESM per ciascuna pompa (opzionale)
  - Segnalazione singola di funzionamento EBM (opzionale)

### Principio di funzionamento

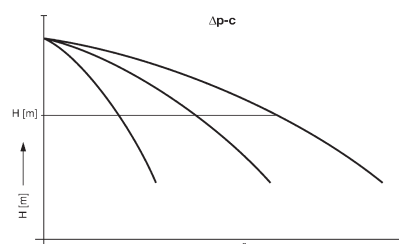

#### Modo di regolazione $\Delta p-c$

In regolazione  $\Delta p-c$  la differenza di pressione è misurata dal sensore tra due punti dell'impianto ed è mantenuta costante al valore H impostato per la prevalenza, in tutto il campo di portata consentito.

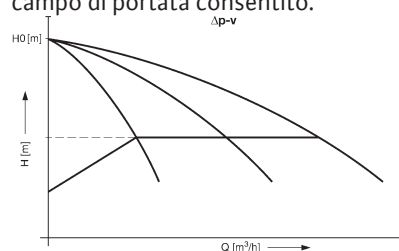

#### Modo di regolazione $\Delta p-v$

In regolazione  $\Delta p-c$ , solo la prima pompa è regolata nel modo regolazione  $\Delta p-v$ , quando si accendono le altre pompe queste sono regolate nel modo regolazione  $\Delta p-c$ .

#### Descrizione Pannello di controllo

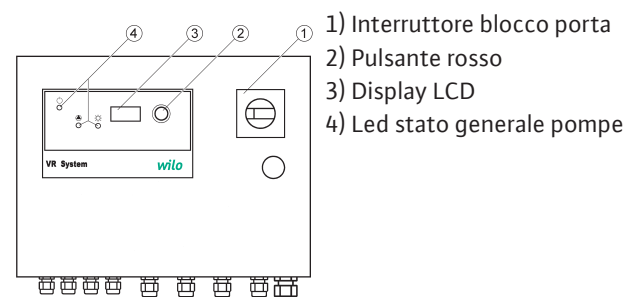



### Particolarità/vantaggi del prodotto

- Comandi semplici: Display, e icone intuitive
- Cronologia stato di funzionamento (fino a 16 segnalazioni singole)
- Visualizzazione sul Display
  - Stato delle pompe e del modulo elettronico,
  - Valore set-point
- Parametri di regolazione avanzati: 2 valori di consegna impostabili, possibilità di regolazione remota del valore di consegna
- **Integrazione in sistemi BMS (opzionale):**
  - BACnet,
  - Modbus RTU(RS 232)
  - LON

## Wilo-Sistema SCe-HVAC

### Tipo

→ per impianti a pompa singola e a più pompe fino a 4 pompe complessive (4 motori elettrici) es. 4 pompe singole "IP-E/IL-E" o 2 pompe gemellari "DP-E/DL-E".

→ **Le pompe devono essere tutte dello stesso modello**

→ Modo di regolazione:

- Pressione costante, p-c
- Differenza di pressione costante,  $\Delta p-c$
- Differenza di pressione variabile,  $\Delta p-v$
- Regolatore di temperatura,  $n=f(T_x)$
- Regolatore numero di giri,  $n=f(\text{analogico } I_n)$
- Differenza di temperatura, costante  $\Delta T$

### Funzioni disponibili

- Regolatore PID
- Contatore di servizio integrato - singolo e cumulativo
- Ottimizzazione del tempo di funzionamento
- Protezione motore mediante collegamento del contatto di protezione avvolgimento (WSK) e della segnalazione cumulativa di blocco (SSM)
- Display LCD con retroilluminazione
- Indicatore di stato (pompe e convertitori di frequenza)
- Visualizzazione definita delle informazioni sui blocchi e archiviazione nella memoria della cronologia
- Controllo interruzioni linea dei sensori (p/T...)
- Scambio automatico delle pompe
- Selezione della pompa di riserva
- Scheda segnalazioni integrata (opzionale)
- Configurazione pannello di controllo:
  - WM (montaggio a parete)
  - BM (armadio)
- Indice di protezione IP54
- Per pompe con potenza nominale di  $P_2 = 1,5 - 22 \text{ kW}$

- Campo di modulazione della velocità tra il 100% e il 40% della velocità nominale del motore
- Segnali di uscita: 0 - 10 V
- Temperatura ambiente ammessa da 0 °C a +40 °C

### Funzioni di comando e segnalazione remota

- Impostazione della velocità con segnale (4-20 mA)
- Impostazione del valore di consegna (4 - 20 mA)
- Contatti liberi da potenziale:
  - Inserimento/disinserimento pompa
  - Funzione antigelo tramite ingresso digitale
  - Segnalazione cumulativa di blocco
  - Segnalazione cumulativa di funzionamento
  - Commutazione sul secondo valore di consegna

Sono disponibili i seguenti ingressi e uscite di comando e controllo opzionali:

- Riarmo a distanza della segnalazione cumulativa di blocco
- Segnali individuali di funz. e blocco per pompe e convertitori
- Commutazione automatico/manuale

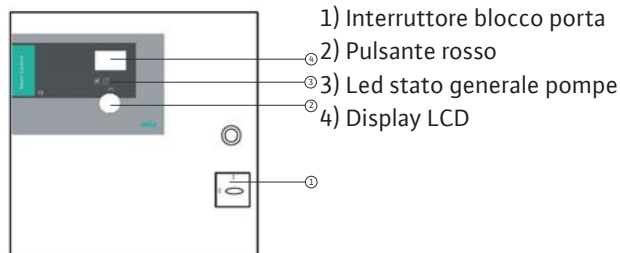





#### Particolarità/vantaggi del prodotto

- **Comandi semplici:** Display Touch-screen; con visualizzazione di testo in chiaro multilingue oppure con icone.
- **Sistema di facile utilizzo:** Memorizzazione e visualizzazione dei dati di funzionamento,
- **Sistema affidabile:** controllo dell'interruzione di linea per i sensori, salvamotore, indicazione di stato per i motori.
- **Parametri di regolazione ampliati:** 3 valori di consegna impostabili, regolazione PID.
- **Moduli opzionali per il collegamento a sistemi BMS bus:** Profibus, CANBus, Modbus RTU, LON, BACnet e altri. Possibilità di trasmissione dati remota con modem GPRS.

## Wilo-Sistema CCE-HVAC

### Tipo

→ per impianti a pompa singola e a più pompe fino a 6 pompe complessive (6 motori elettrici) es. 6 pompe singole "IP-E/IL-E" o 3 pompe gemellari "DP-E/DL-E".

→ **Le pompe devono essere tutte dello stesso modello**

- Modo di regolazione  $\Delta p-c$ ;  $\Delta p-v$ ;  $\Delta p-(\pm)T$ ;  $\Delta T$ ; P-c
  - Pressione costante, p-c
  - Differenza di pressione costante,  $\Delta p-c$
  - Differenza di pressione variabile,  $\Delta p-v$
  - Regolatore di temperatura,  $n=f(T)$
  - Regolatore numero di giri,  $n=f(\text{analogico } I_n)$
  - Regolazione della temperatura, T-c
  - Differenza di temperatura, costante  $\Delta T-c$
  - Differenza di temperatura, variabile  $\Delta T-v$

### Funzioni disponibili

- Regolatore PID
- Orologio in tempo reale integrato con commutazione ora solare/legale
- Contatore di servizio integrato con conteggio singolo/cumulativo
- Ottimizzazione del tempo di funzionamento per gli impianti a più pompe
- Protezione motore mediante collegamento del contatto di protezione avvolgimento (WSK) e della segnalazione cumulativa di blocco (SSM)
- Display tattile (Touch-Screen) retroilluminato a colori
- Indicatore di stato (pompe e convertitori di frequenza)
- Gestione a menu orientata all'utente con visualizzazione di testo in chiaro multilingue oppure con icone
- Memorizzazione ed emissione di molteplici dati di funzionamento
- Visualizzazione definita delle informazioni sui blocchi e archiviazione nella memoria della cronologia

- Controllo interruzioni linea dei sensori (p/T...)
- Indice di protezione IP 54
- Alimentazione di rete 3~400 V, 50/60 Hz
- Per pompe con potenza nominale di  $P_2 = 0,37 - 22 \text{ kW}$
- Controllo della velocità tra velocità minima e massima della pompa
- Segnali di uscita 0/2 – 10 V, 0/4 – 20 mA
- Temperatura ambiente ammessa da 0 °C a +40 °C

### Funzioni di comando e segnalazione remota

- Impostazione della velocità remota (4 – 20 mA)
- Impostazione remota del valore di consegna (4 – 20 mA, opzionale 0/2 – 10 V) preselezionabile
- Contatti liberi da potenziale:
  - Inserimento/disinserimento pompa
  - Funzione antigelo tramite ingresso digitale
  - Segnalazione cumulativa di funzionamento / blocco
- Selettore di servizio "Rete – Emergenza – Esercizio"
- Commutazione sul secondo/terzo valore di consegna

Sono disponibili i seguenti ingressi e uscite di comando e controllo opzionali:

- Riarmo a distanza della segnalazione cumulativa di blocco
- Commutazione nel funzionamento come servomotore
- Segnali individuali di funz. e blocco per pompe e convertitori
- Commutazione automatico/manuale
- Moduli di interfaccia a reti di Building Management System (Can; Modbus; Lonworks)

## Wilo-Select 4 online – Il consulente per le pompe

La nuova applicazione online per la vostra progettazione pompe

### I vostri vantaggi:

- Impiego semplice e confortevole
- Configurazione sicura dei prodotti con calcoli idraulici
- Comparazione dei tempi di ammortamento e dei costi di gestione e del ciclo di vita in un colpo d'occhio
- Supporto ottimale per la progettazione e la consulenza ai clienti

Grazie al nuovo Wilo-Select 4 online potrete sperimentare la 4<sup>a</sup> generazione del dimensionamento pompe – un'esperienza fatta di flessibilità, comodità, efficienza e potenza.

I dati aggiornati dei prodotti saranno sempre a vostra disposizione grazie al collegamento Internet. Semplicemente online, ovunque voi siate.

Ora la progettazione è più semplice, rapida e sicura che mai: bastano 4 passi per ottenere il prodotto suggerito o un'analisi affidabile dei costi per ciclo di vita (LCC-Check).

- Aprire l'anteprima dei costi di esercizio
- Selezionare le pompe di confronto
- Controllare le basi di calcolo
- Confrontare i costi sul ciclo di vita e i tempi di ammortamento

Grazie al confronto integrato dei costi sul ciclo di vita (LCC-Check) è possibile informarsi in modo semplice sulla convenienza delle pompe attualmente installate presso i propri clienti.

Wilo-Select 4 online calcola la pompa sostitutiva ideale e vi fornisce risultati convincenti sotto forma di potenziale di risparmio in Euro, indicando inoltre il tempo di ammortamento in un unico foglio dati.

I nuovi confronti tra prodotti rappresentano la base per la consulenza tecnica e possono essere utilizzati a sostegno delle decisioni durante il colloquio con il cliente.

Un'ulteriore novità è costituita dalla scelta degli accessori per le applicazioni per l'alimentazione idrica e per acque cariche e reflue, attraverso un'interfaccia intuitiva che consente di creare rapidamente capitolati e offerte.

Ulteriori funzioni di esportazione e l'invio diretto per e-mail dei documenti di offerta e capitolato garantiscono una comunicazione efficiente con i propri clienti.

Si consiglia di registrare un account e accedere ai prezzi di listino, le altre specifiche del mercato ed informazioni sui prodotti. Troverete anche la cartella personale del progetto per un facile back-up delle configurazioni.

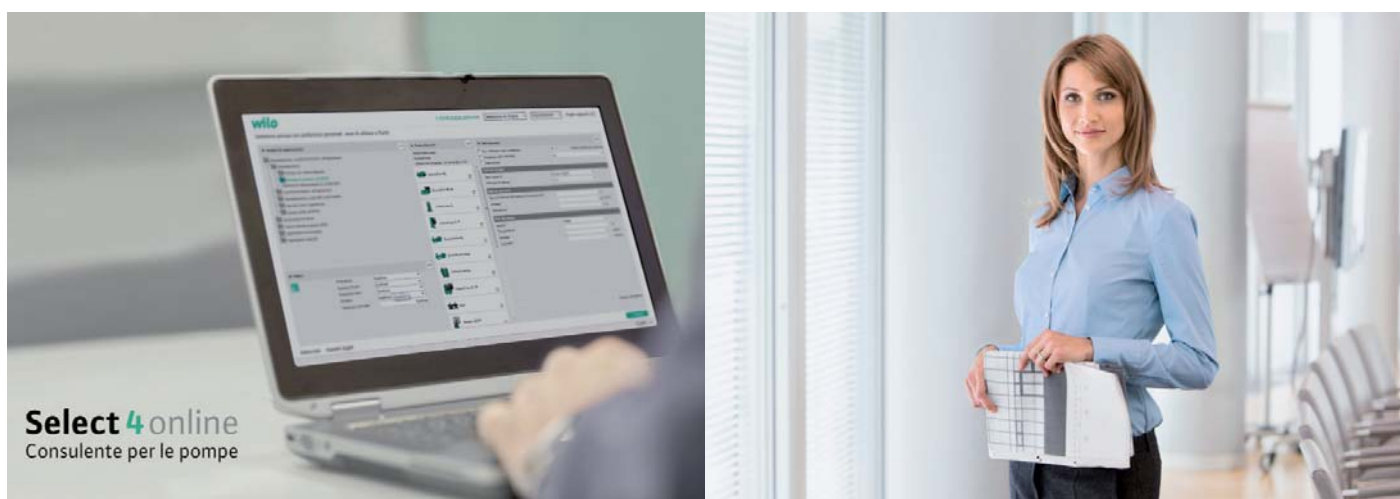

## Wilo App:

Il consulente per le pompe sempre a portata di mano.

Con Wilo App hai tutto il mondo delle pompe in formato tascabile.

Wilo App "Consulente Wilo" è disponibile gratuitamente, è facile da usare e contiene molte informazioni che prima erano disponibili solo su internet o documentazione cartacea. Sia nella sostituzione di una pompa che durante la visita presso il cliente il "Consulente Wilo" vi supporterà nelle attività quotidiane in modo affidabile.





A cura del Marketing Group Italy  
info.marketing@wilo.it

WILO Italia Srl  
Via Novegro 1/A  
20090 Segrate (MI)  
T +39 02 5538351  
F +39 02 55303374  
wilo.italia@wilo.it  
www.wilo.it

Società soggetta a direzione e coordinamento di WILO SE