

Pioneering for You

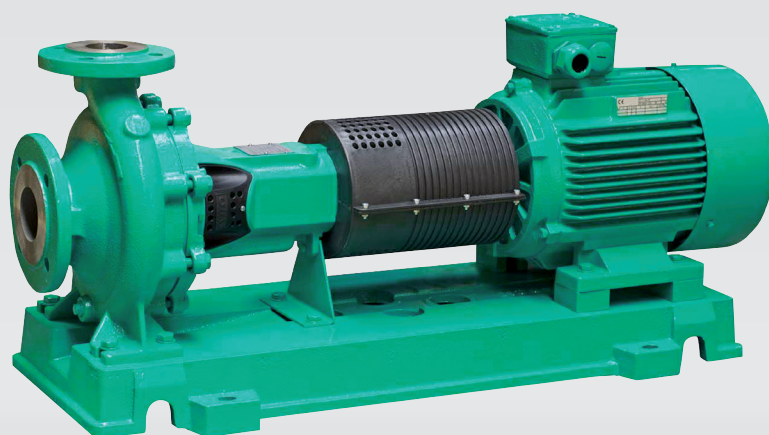

Range Leaflet – Edition 03/2016 – 50 Hz

Wilo-CronoNorm-NL



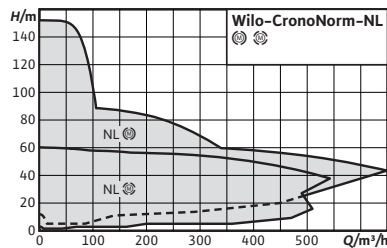

Baureihenänderung



Wilo-CronoNorm-NL

Bauart

Einstufige Niederdruck-Kreiselpumpe mit axialer Ansaugung, gemäß EN 733, auf Grundplatte montiert.

Einsatz

- Förderung von Heizungswasser (nach VDI 2035), Kaltwasser und Wasser-Glykol-Gemischen ohne abrasive Stoffe in Heizungs-, Kaltwasser- und Kühlsystemen.
- Anwendungen bei der Bewässerung, Gebäudetechnik, allgemeine Industrie, Kraftwerke, etc.

Besonderheiten/Produktvorteile

- Verringerte Life-Cycle-Costs durch optimierte Wirkungsgrade
- Drehrichtungsunabhängige, zwangsumflutete Gleitringdichtung
- niedrige NPSH-Werte, beste Kavitationseigenschaften
- Wellenkupplung mit oder ohne Ausbaucupplung

Typenschlüssel

Beispiel	NL 40/200B-11/2
NL	Standardpumpe mit axialer Ansaugung
40	DN für den Druckflansch
200	Laufradnennweite [mm]
B	Hydraulische Ausführung
11	Motornennleistung P_2 [kW]
2	Polzahl

Technische Daten (Baureihe)	
Mindesteffizienzindex (MEI)	≥ 0,4
Zulässige Fördermedien (andere Medien auf Anfrage)	
Heizungswasser (gemäß VDI 2035)	•
Kühl- und Kaltwasser	•
Wasser-Glykol-Gemische (bei 20-40 Vol.-% Glykol u. Medientemperatur ≤ 40 °C)	(ab 10 Vol.-% Glykol: Leistungsüberprüfung erforderlich; bis 50% Glykol: Gleitringdichtung auf Anfrage)
Zulässiger Einsatzbereich	
Standardausführung für Betriebsdruck p_{max}	16 bar

• = zulässig, - = nicht zulässig

Technische Daten (Baureihe)	
Temperaturbereich bei max. Umgebungstemperatur +40 °C	-20...+120°C (Ausführung mit Gleitringdichtung) -20...+105°C (Ausführung mit Stopfbuchspackung)
Umgebungstemperatur	-15°C ... 40°C
Aufstellung in geschlossenen Gebäuden	•
Aufstellung im Freien	Sonderausführung gegen Mehrpreis
Elektroanschluss	
Netzanschluss	3~400 V, 50 Hz
Nennzahl n	1450/2900 1/min

• = zulässig, - = nicht zulässig

Technische Daten (Baureihe)

Motor/Elektronik

IEC-Norm-Motor	•
Schutzart	IP 55
Isolationsklasse	F
Kaltleiterfühler	•
Motorschutz bauseits erforderlich	für die Installation bauseits zu stellen
Motor-Effizienzklasse	IE3 (für Motoren $\geq 0,75$ kW)
Drehzahlregelung	Wilo Regelgeräte, externer Frequenzumformer (gegen Mehrpreis)
Motorwicklung bis 3 kW	230 V Δ /400 V Y, 50 Hz
Motorwicklung ab 4 kW	400 V Δ /690 V Y, 50 Hz
Andere Spannungen/Frequenzen	Sonderausführung gegen Mehrpreis

• = zulässig, - = nicht zulässig

Technische Daten (Baureihe)

Werkstoffe

Pumpengehäuse	EN-GJL-250
Druckdeckel	EN-GJL-250
Lagerträger	EN-GJL-250
Lauftrad	EN-GJL-250
Lauftrad (Sonderausführung)	G-CuSn10
Pumpenwelle	X30Cr13
Gleitringdichtung	AQ1EGG
Andere Gleitringdichtungen	auf Anfrage (abhängig vom Fördermedium)
Ungekühlte Stopfbuchse	Ausführung ohne Mehrpreis

• = zulässig, - = nicht zulässig

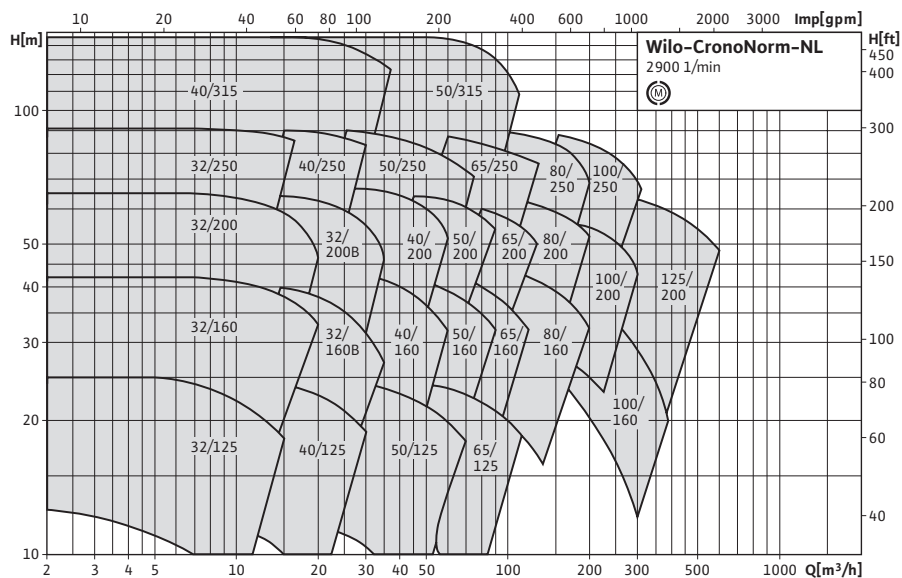
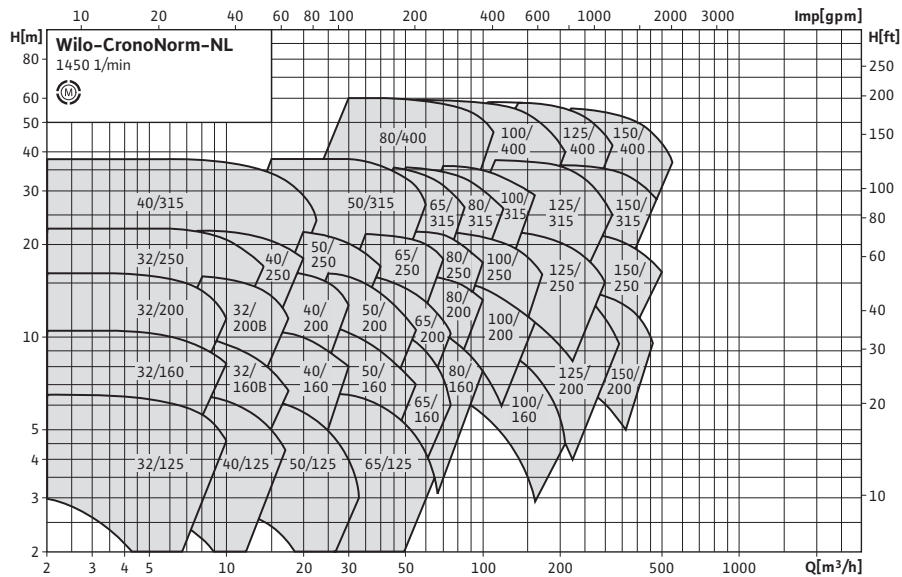

Ausstattung/Funktion

Einstufige Niederdruck-Kreiselpumpe in Blockbauart mit Kupplung, Kupplungsschutz, Motor und Grundplatte
 → Gleitringdichtung oder Stopfbuchspackung

Lieferumfang

- Pumpe
- Einbau- und Betriebsanleitung
- Pumpe mit freiem Wellenende **oder**
- Pumpe auf Grundplatte mit Kupplung und Kupplungsschutz, ohne Motor **oder**
- vollständig montierte Pumpe auf Grundplatte mit Elektromotor

Optionen

- Andere Werkstoffe und Ausführungen auf Anfrage
- Andere Spannungen und Frequenzen auf Anfrage

Zubehör

Automatische Drehzahlkontrolle:
 Wilo-Pumpen-Regelsystem für automatische, stufenlose Leistungsregelung von Pumpen. Für weitere Informationen zum Thema „Schalt- und Regelgeräte“ wenden Sie sich bitte an Wilo.

Hinweis

→ Motoren mit einer Energieeffizienzklasse IE3 für Motore $\geq 0,75$ kW

Allgemeine Hinweise – ErP-(Ökodesign-)Richtlinie

- Der Referenzwert MEI für Wasserpumpen mit dem besten Wirkungsgrad ist $\geq 0,70$.
- Der Wirkungsgrad einer Pumpe mit einem korrigierten Laufrad ist gewöhnlich niedriger als der einer Pumpe mit vollem Laufraddurchmesser. Durch die Korrektur des Laufrads wird die Pumpe an einen bestimmten Betriebspunkt angepasst, wodurch sich der Energieverbrauch verringert. Der Mindesteffizienzindex (MEI) bezieht sich auf den vollen Laufraddurchmesser.
- Der Betrieb dieser Wasserpumpe bei unterschiedlichen Betriebspunkten kann effizienter und wirtschaftlicher sein, wenn sie z. B. mittels einer variablen Drehzahlsteuerung gesteuert wird, die den Pumpenbetrieb an das System anpasst.
- Informationen zum Effizienzreferenzwert sind unter www.europump.org/efficiencycharts abrufbar.
- Pumpen mit einer Aufnahmeleistung > 150 kW oder einer Fördermenge $Q_{BEP} < 6$ m³/h fallen nicht unter die Ökodesignverordnung für Wasserpumpen. Daher wird kein MEI-Wert ausgewiesen.

Klemmenplan

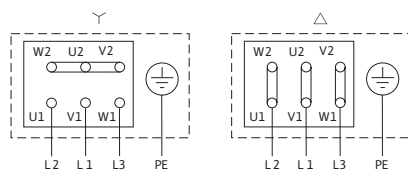

Δ: Anschlussschema Dreieckschaltung
 Y: Anschlussschema Sternschaltung

Motorschutzschalter bauseits erforderlich. Drehrichtung kontrollieren! Zur Drehrichtungsänderung zwei beliebige Phasen tauschen.

3~690 V Y
 3~400 V Δ

Nach Entfernen der Brücken ist Y-Δ-Anlauf möglich.

Empfohlene Grenzwerte für die Auslegung

Wilo-CronoNorm-NL...	Faktor Q_{min}	Faktor Q_{max}
32/125	0,3	1,2
32/160	0,3	1,2
32/200	0,3	1,2
32/250	0,3	1,1
40/125	0,3	1,2
40/160	0,3	1,2
40/200	0,3	1,2
40/250	0,3	1,1
40/315	0,3	1,1
50/125	0,3	1,2
50/160	0,3	1,2
50/200	0,3	1,1
50/250	0,3	1,2
50/315	0,3	1,2
65/125	0,3	1,2
65/160	0,3	1,2

Empfohlene Grenzwerte für die Auslegung

Wilo-CronoNorm-NL...	Faktor Q_{min}	Faktor Q_{max}
65/200	0,3	1,2
65/250	0,3	1,1
65/315	0,3	1,2
80/160	0,3	1,2
80/200	0,3	1,2
80/250	0,3	1,2
80/315	0,3	1,2
80/400	0,3	1,2
100/160	0,5	1,2
100/200	0,5	1,2
100/250	0,5	1,1
100/315	0,3	1,2
100/400	0,3	1,2
125/200	0,5	1,2
125/250	0,5	1,2
125/315	0,3	1,2
125/400	0,3	1,2
150/200	0,5	1,1
150/250	0,3	1,1
150/315	0,3	1,2
150/400	0,3	1,2

Schnittzeichnung

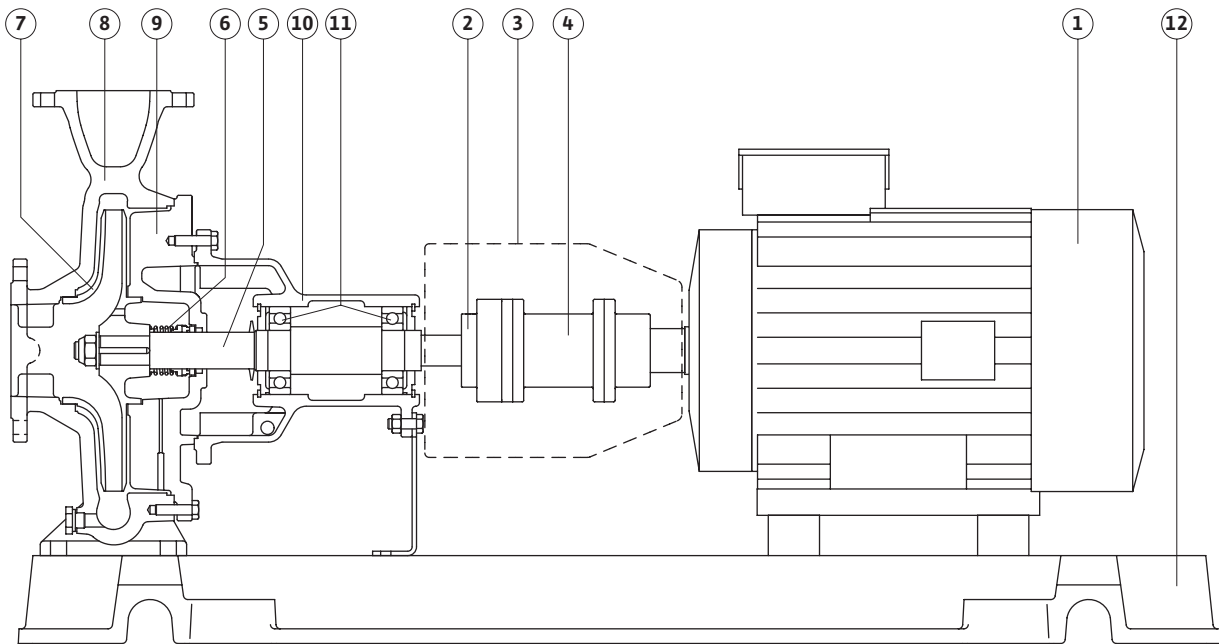

- | | | | |
|-------------------|---------------------|-----------------|----------------|
| 1 Motor | 4 Abstandsstück | 7 Laufrad | 10 Lagerträger |
| 2 Kupplung | 5 Welle | 8 Pumpengehäuse | 11 Kugellager |
| 3 Kupplungsschutz | 6 Gleitringdichtung | 9 Gehäusedeckel | 12 Grundplatte |

Motordaten							
Wilo-CronoNorm-NL...	Polzahl	Motorgröße	Nennstrom (ca.)	Leistungs-faktor	Motorwirkungsgrad		
P_2 W		MG	I_N 3~400 V A	$\cos \varphi$	η_m 50%	η_m 75% %	η_m 100%
0,37 kW	4	71	1,08	0,73	65,0	68,0	68,0
0,55 kW	4	80	1,27	0,82	75,0	76,5	76,5
0,55 kW	2	71	1,25	0,88	70,0	72,0	72,0
0,75 kW	4	80	1,62	0,81	80,0	82,0	82,5
0,75 kW	2	80	1,58	0,82	80,0	82,0	82,0
1,1 kW	4	90S/L	2,34	0,80	83,0	84,5	84,8
1,1 kW	2	80	2,32	0,82	81,0	83,5	83,5
1,5 kW	4	90S/L	3,15	0,83	84,0	86,0	86,0
1,5 kW	2	90S/L	3,14	0,83	83,0	85,0	85,0
2,2 kW	4	100L	4,56	0,80	86,5	87,0	87,0
2,2 kW	2	90S/L	4,58	0,83	86,0	86,5	86,3
3 kW	4	100L	6,15	0,80	87,0	88,0	88,0
3 kW	2	100L	5,92	0,86	85,5	87,3	87,3
4 kW	4	112M	8,00	0,79	88,7	89,1	89,1
4 kW	2	112M	7,72	0,86	88,1	89,1	89,5
5,5 kW	4	132S	10,30	0,85	90,0	90,7	90,7
5,5 kW	2	132S	10,60	0,88	88,3	89,7	90,0
7,5 kW	4	132	14,90	0,61	87,4	89,3	89,8
7,5 kW	2	132	13,20	0,91	88,9	90,3	90,3
9 kW	4	132	16,60	0,88	90,4	91,1	91,1
9 kW	2	132	15,90	0,90	88,6	90,7	90,4
11 kW	4	160	22,00	0,63	90,1	91,6	91,4
11 kW	2	160	18,70	0,93	90,3	91,3	91,4
15 kW	4	160	29,80	0,62	90,7	91,7	91,7
15 kW	2	160	25,40	0,94	90,4	91,6	92,1
18,5 kW	4	180	34,30	0,75	91,7	92,5	92,4
18,5 kW	2	160	31,40	0,92	90,9	92,1	92,0
22 kW	4	180	40,10	0,77	92,0	93,0	92,8
22 kW	2	180	37,00	0,93	91,7	92,9	92,9
30 kW	4	200	54,30	0,86	92,2	93,0	93,1
30 kW	2	200	52,20	0,90	91,8	93,1	93,0
37 kW	4	225	71,30	0,57	90,9	92,8	93,9
37 kW	2	200	63,20	0,90	92,0	93,5	93,2
45 kW	4	225	83,10	0,63	91,7	93,2	94,2
45 kW	2	225	79,20	0,87	93,2	94,1	94,0
55 kW	4	250S/M	98,60	0,85	94,3	94,7	94,7
55 kW	2	250S/M	93,50	0,88	93,6	94,4	94,4
75 kW	4	280S/M	134,00	0,85	94,5	95,1	95,2
75 kW	2	280S/M	130,00	0,88	93,7	94,8	94,9
90 kW	4	280S/M	158,00	0,86	94,9	95,4	95,4
90 kW	2	280S/M	152,00	0,90	94,3	95,2	95,2
110 kW	2	315S/M	189,00	0,88	94,3	95,3	95,4

Motor - Typenschilddaten beachten

Kennlinien

CronoNorm-NL 32/125 (2-polig, 50 Hz)

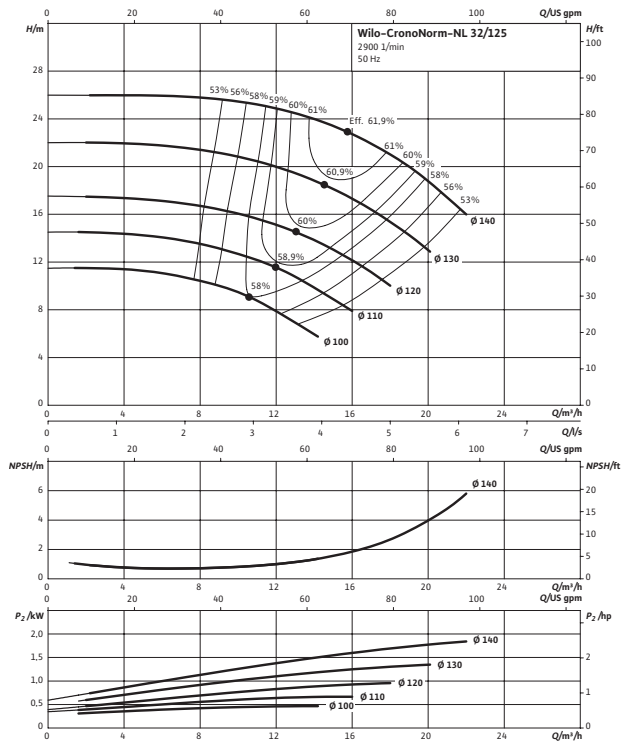

Kennlinien

CronoNorm-NL 32/160 (2-polig, 50 Hz)

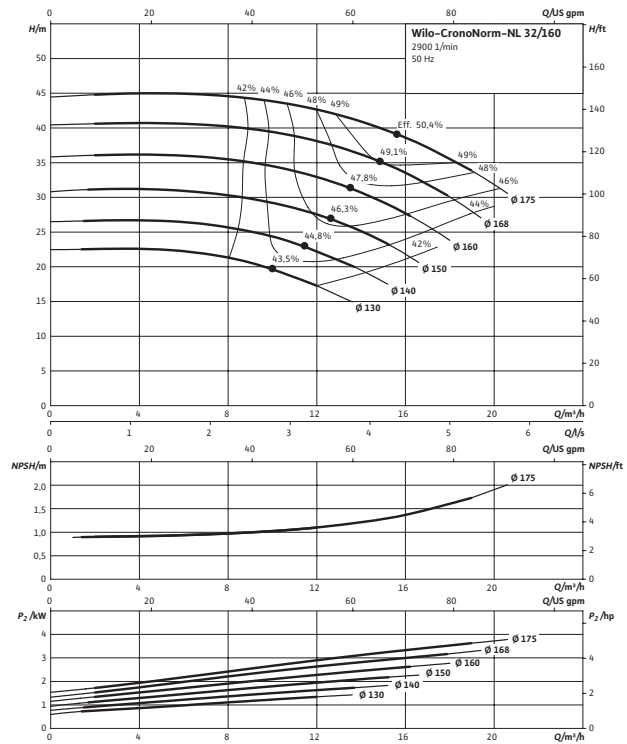

Kennlinien

CronoNorm-NL 32/160B (2-polig, 50 Hz)

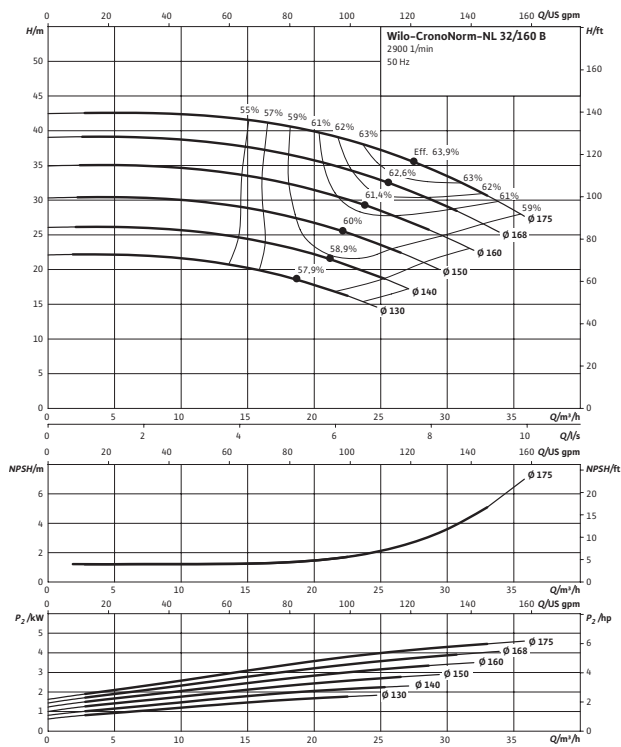

Kennlinien

CronoNorm-NL 32/200 (2-polig, 50 Hz)

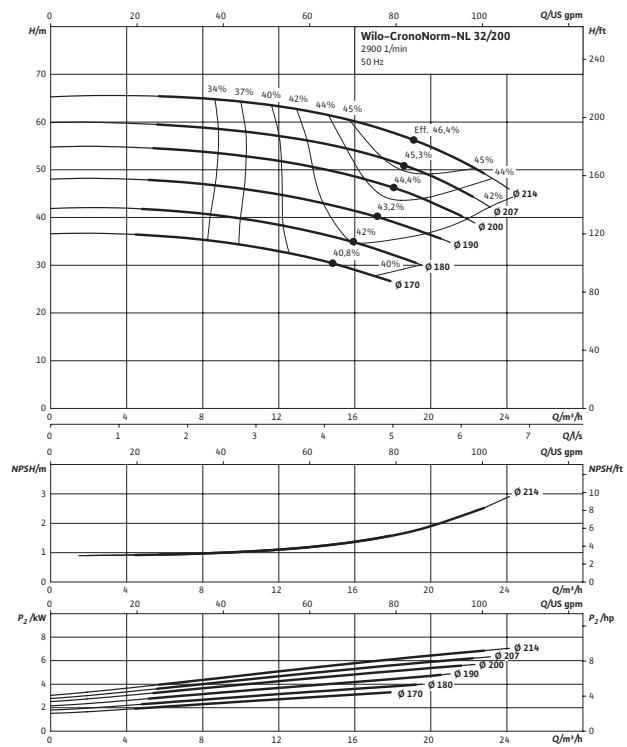

Heizung, Klima, Kälte;
Wasserversorgung

Kennlinien

CronoNorm-NL 32/200B (2-polig, 50 Hz)

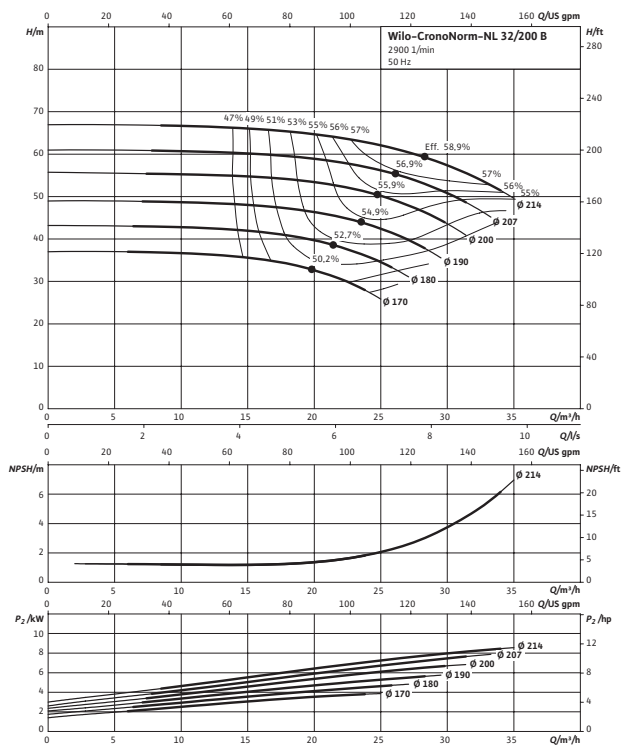

Kennlinien

CronoNorm-NL 32/250 (2-polig, 50 Hz)

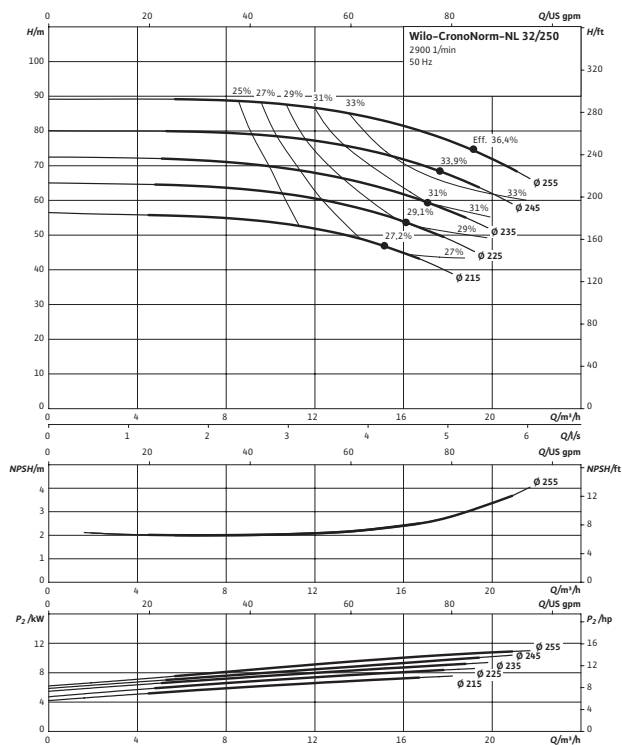

Kennlinien

CronoNorm-NL 40/125 (2-polig, 50 Hz)

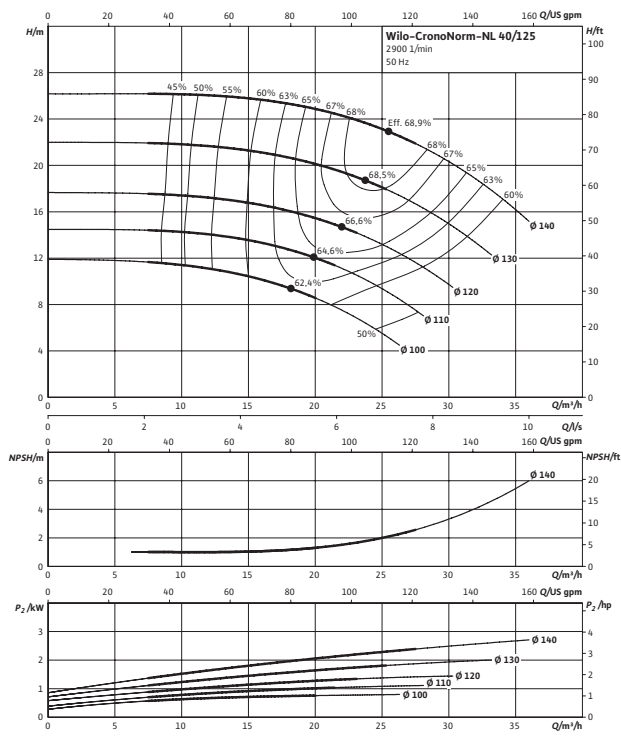

Kennlinien

CronoNorm-NL 40/160 (2-polig, 50 Hz)

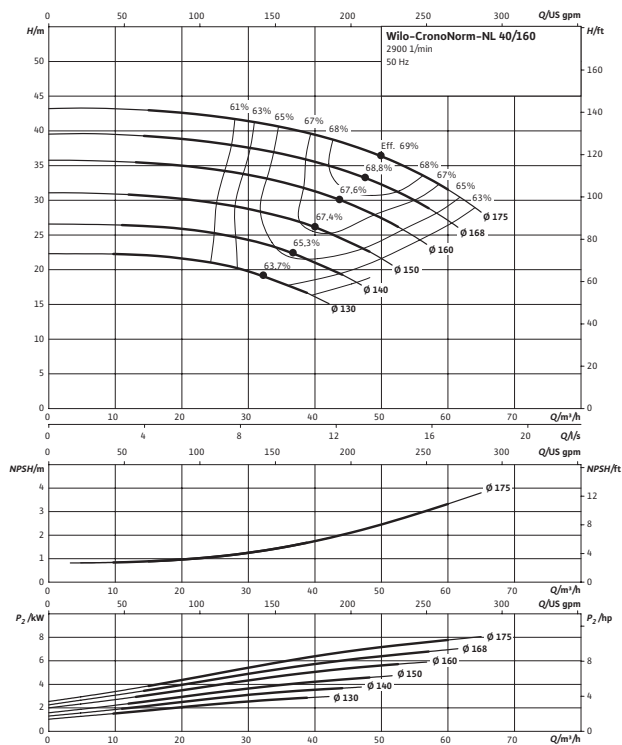

Kennlinien

CronoNorm-NL 40/200 (2-polig, 50 Hz)

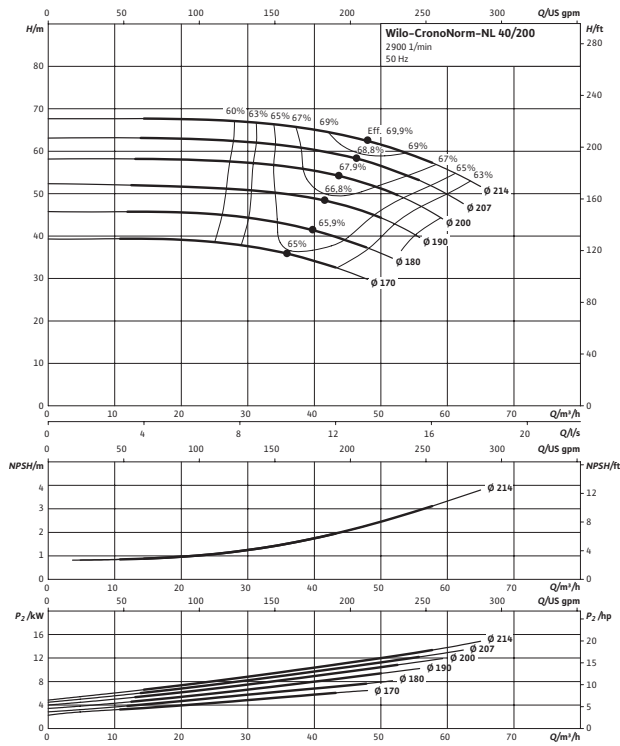

Kennlinien

CronoNorm-NL 40/250 (2-polig, 50 Hz)

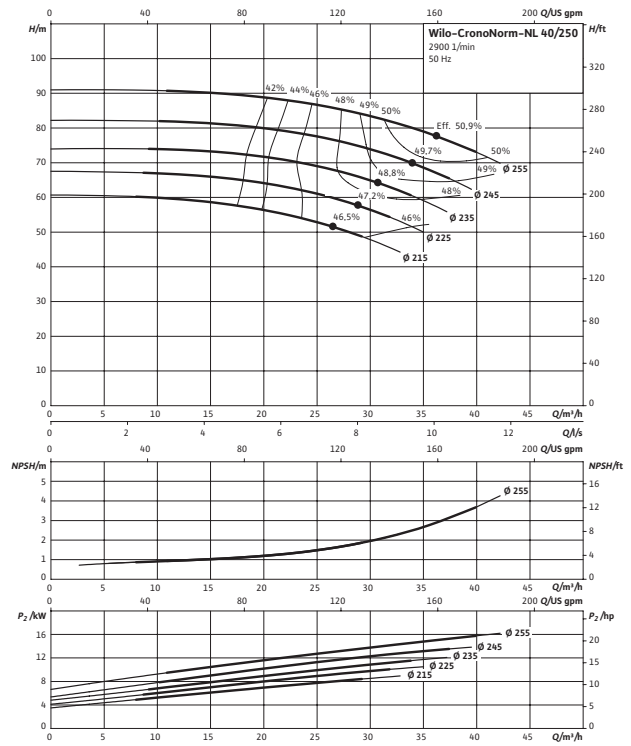

Kennlinien

CronoNorm-NL 40/315 (2-polig, 50 Hz)

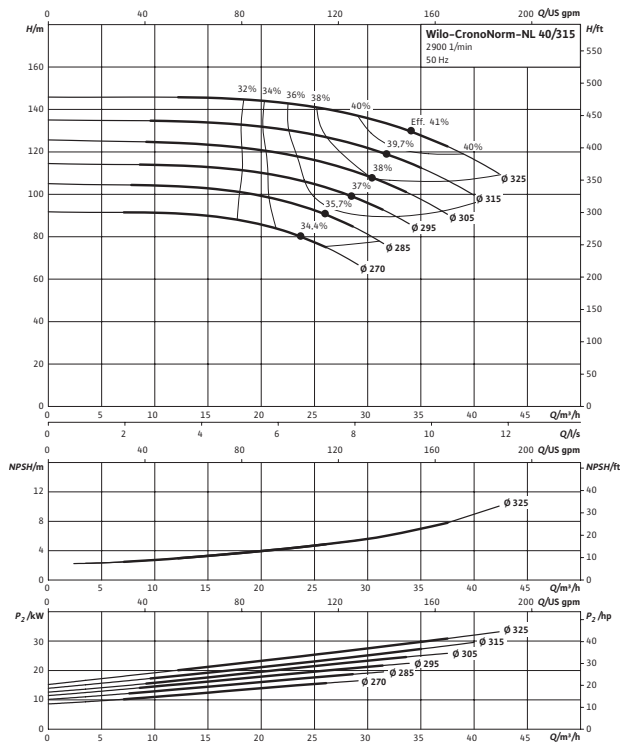

Kennlinien

CronoNorm-NL 50/125 (2-polig, 50 Hz)

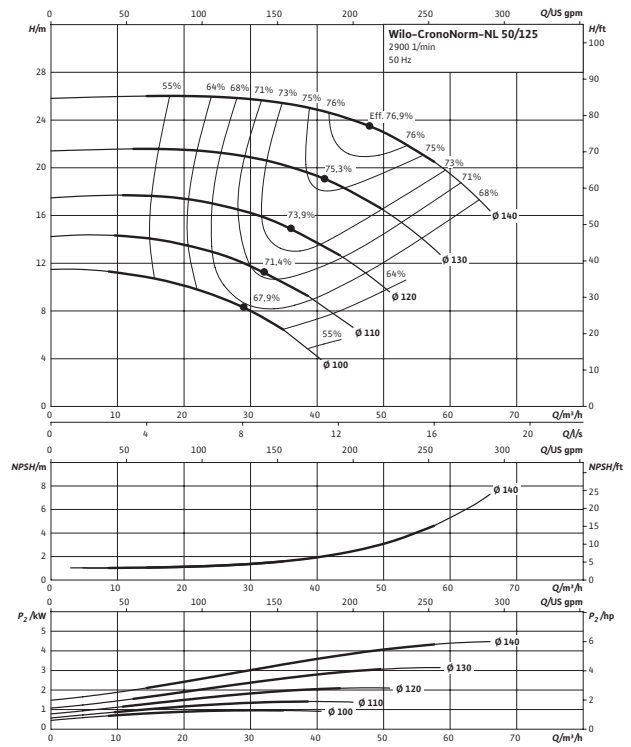

Heizung, Klima, Kälte;
Wasserversorgung

Kennlinien

CronoNorm-NL 50/160 (2-polig, 50 Hz)

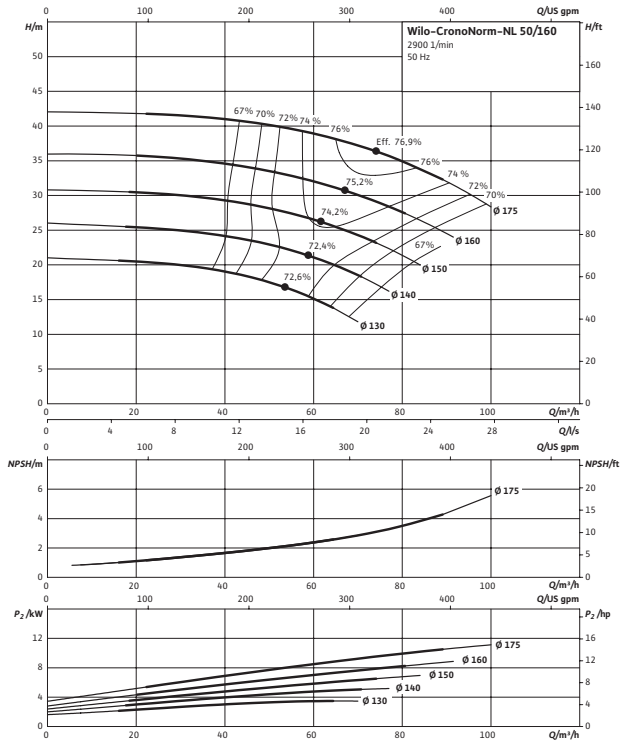

Kennlinien

CronoNorm-NL 50/200 (2-polig, 50 Hz)

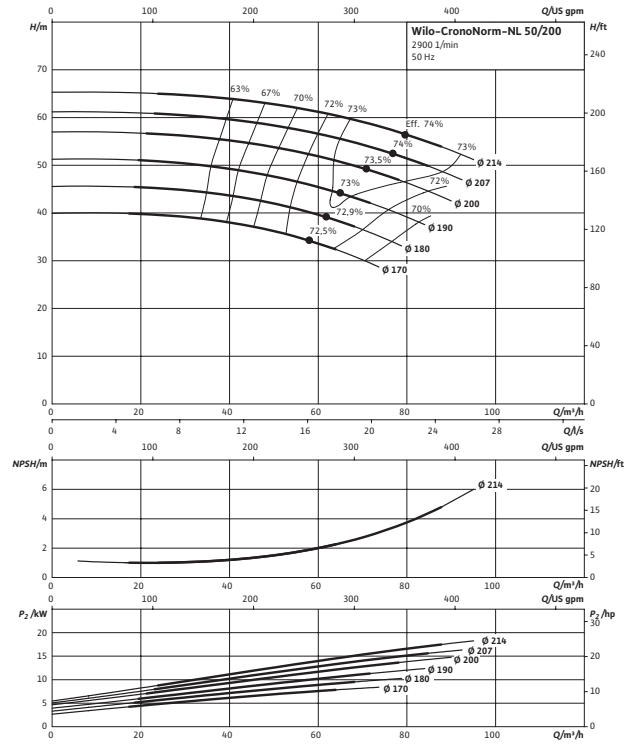

Kennlinien

CronoNorm-NL 50/250 (2-polig, 50 Hz)

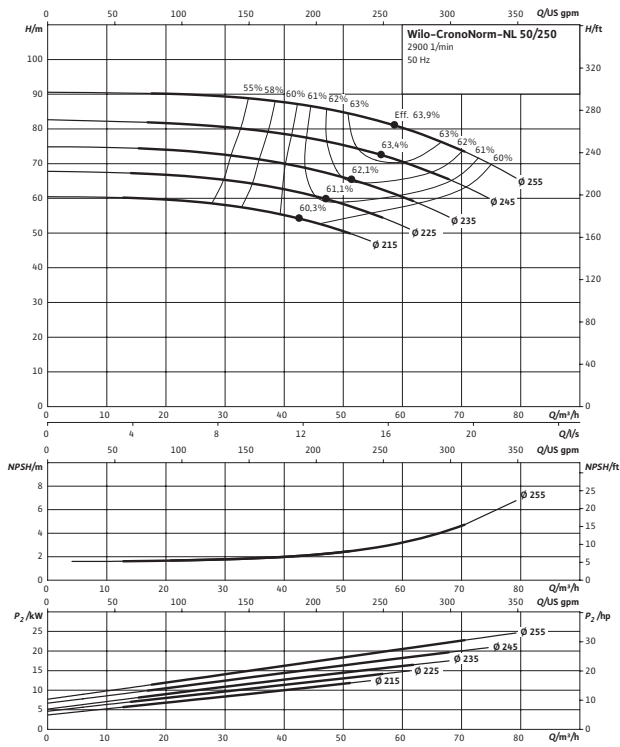

Kennlinien

CronoNorm-NL 50/315 (2-polig, 50 Hz)

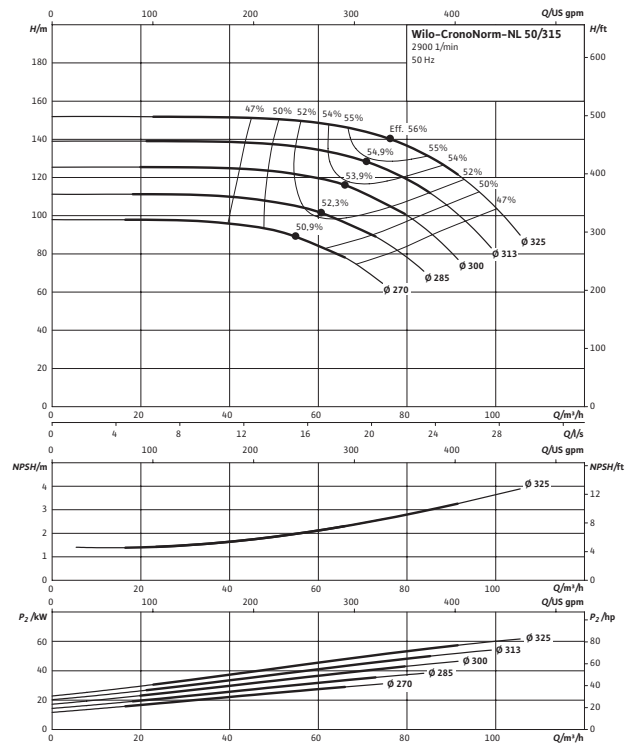

Kennlinien

CronoNorm-NL 65/125 (2-polig, 50 Hz)

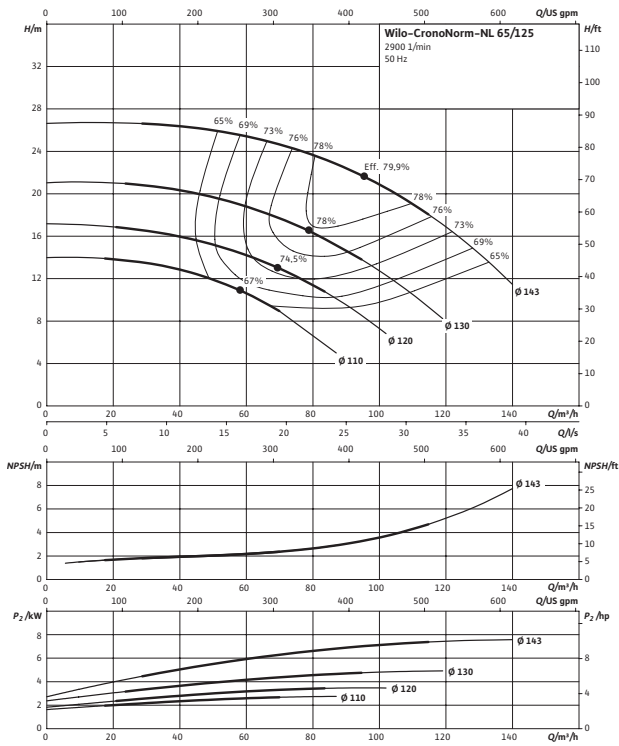

Kennlinien

CronoNorm-NL 65/160 (2-polig, 50 Hz)

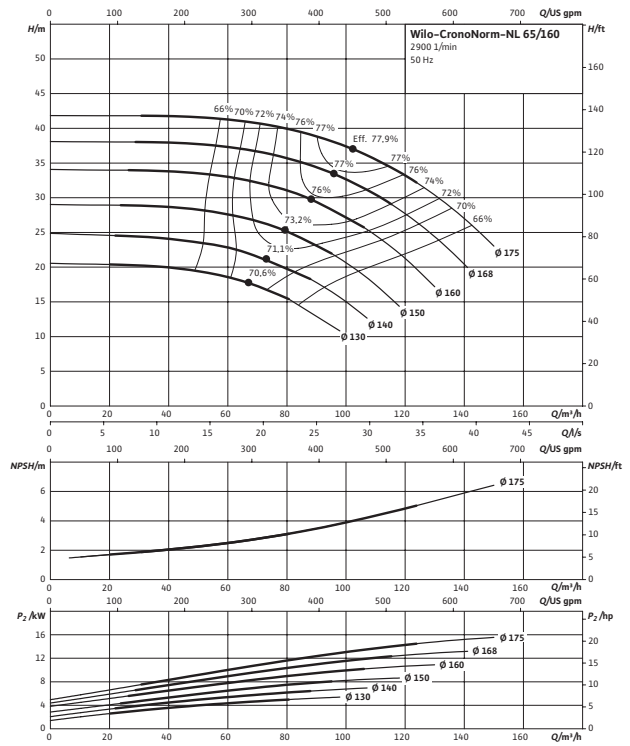

Kennlinien

CronoNorm-NL 65/200 (2-polig, 50 Hz)

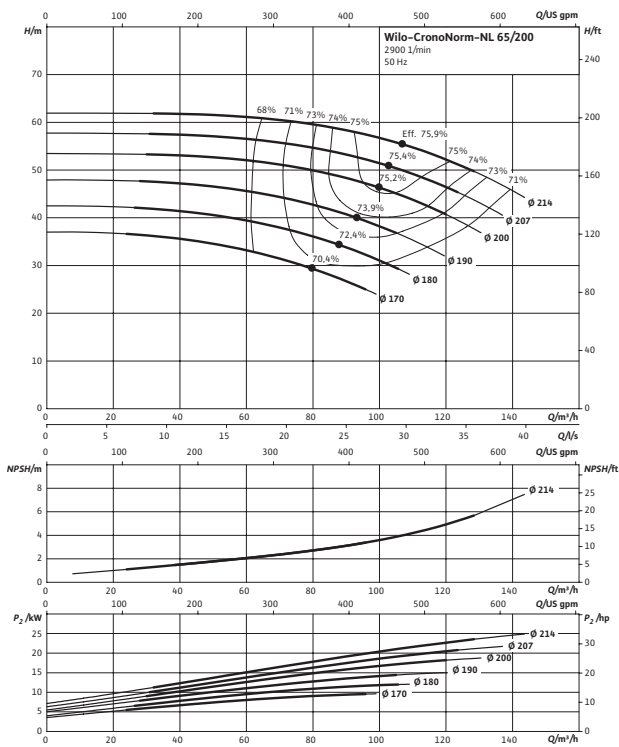

Kennlinien

CronoNorm-NL 65/250 (2-polig, 50 Hz)

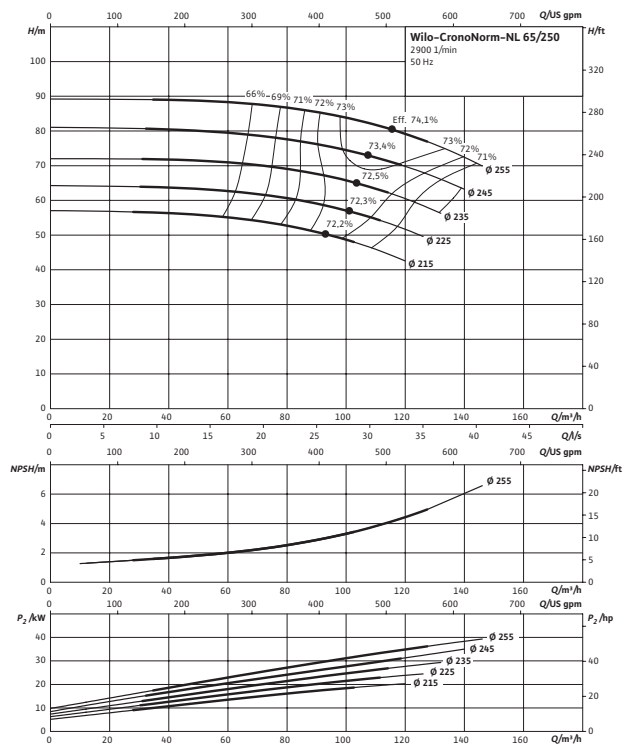

Heizung, Klima, Kälte; Wasserversorgung

Kennlinien

CronoNorm-NL 80/160 (2-polig, 50 Hz)

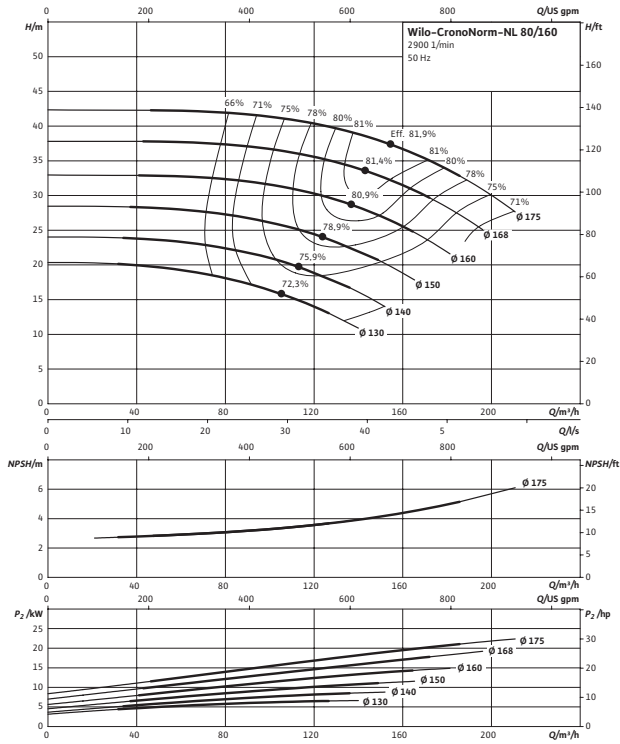

Kennlinien

CronoNorm-NL 80/200 (2-polig, 50 Hz)

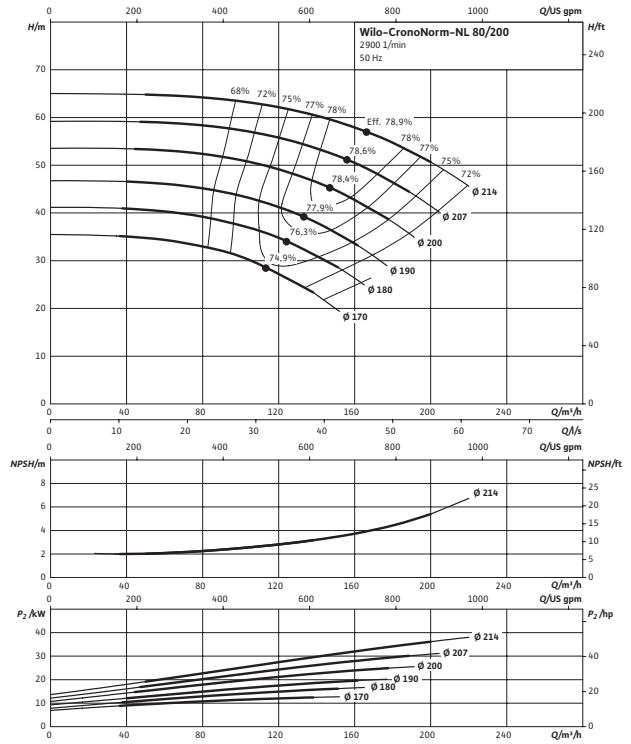

Kennlinien

CronoNorm-NL 80/250 (2-polig, 50 Hz)

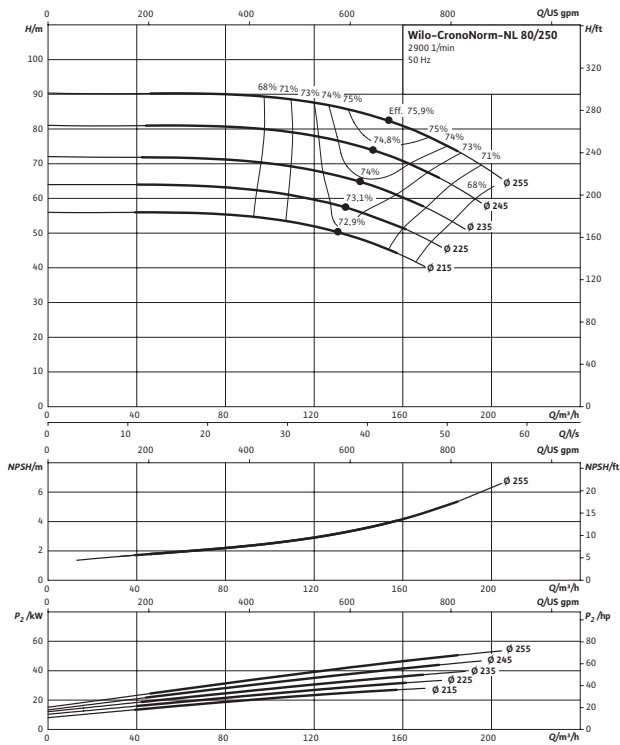

Kennlinien

CronoNorm-NL 100/160 (2-polig, 50 Hz)

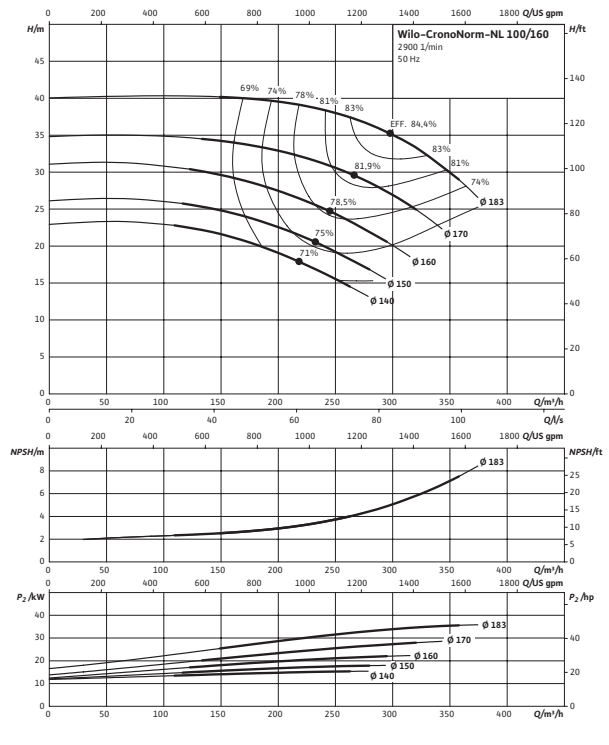

Kennlinien

CronoNorm-NL 100/200 (2-polig, 50 Hz)

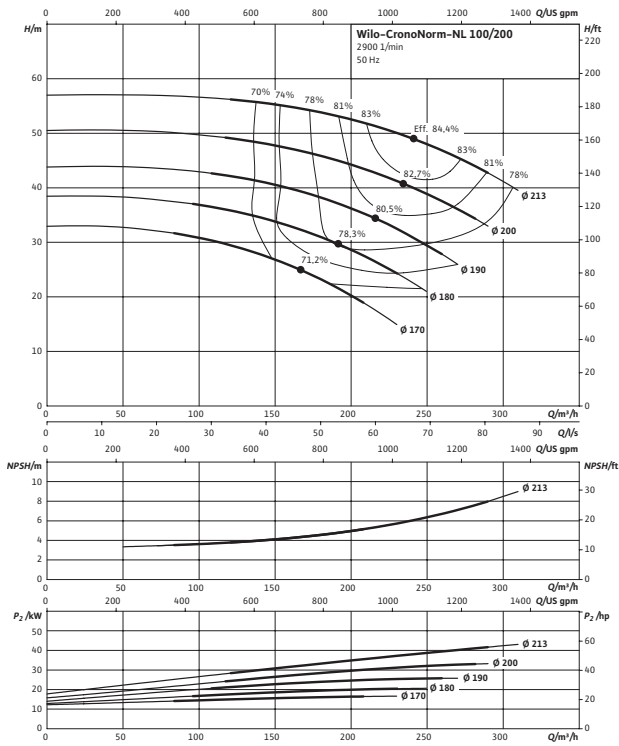

Kennlinien

CronoNorm-NL 100/250 (2-polig, 50 Hz)

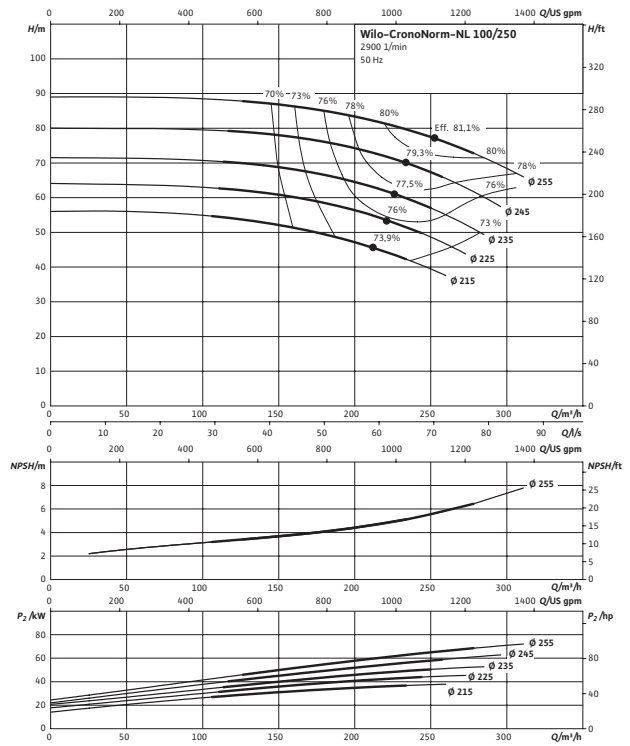

Kennlinien

CronoNorm-NL 125/200 (2-polig, 50 Hz)

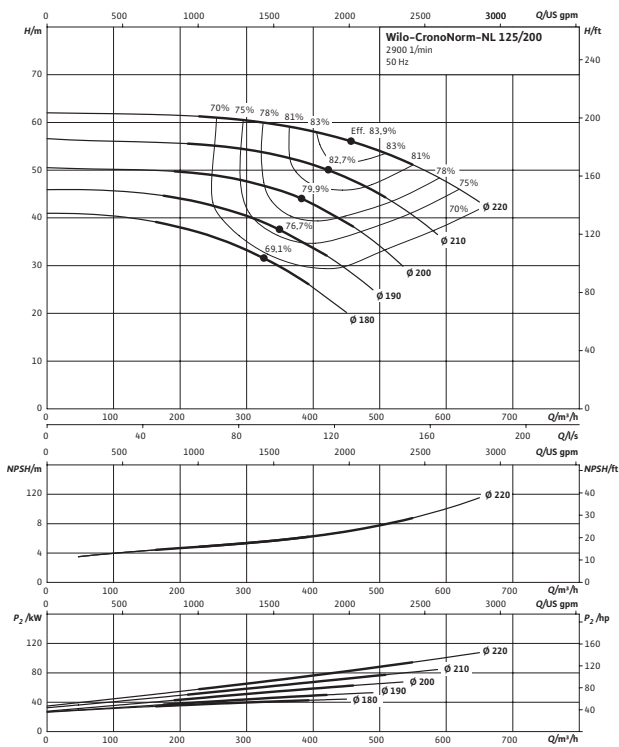

Heizung, Klima, Kälte;
Wasserversorgung

Kennlinien

CronoNorm-NL 32/125 (4-polig, 50 Hz)

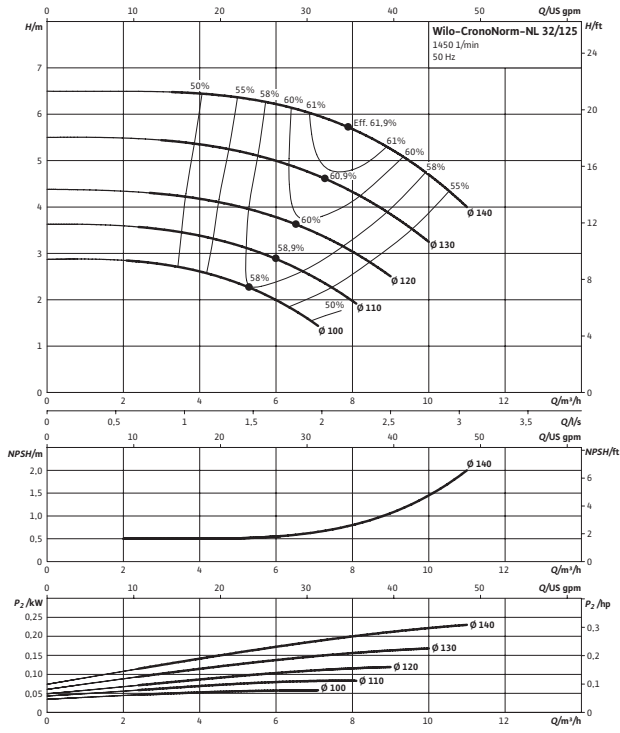

Kennlinien

CronoNorm-NL 32/160 (4-polig, 50 Hz)

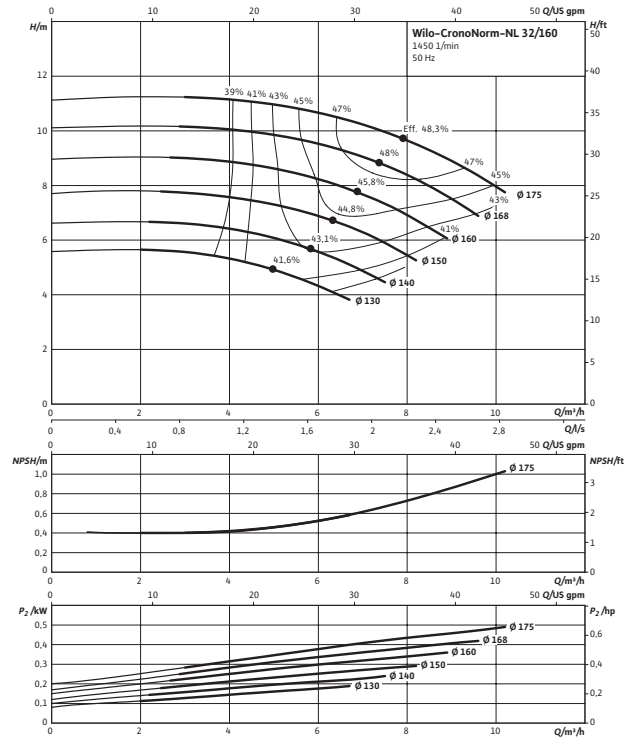

Kennlinien

CronoNorm-NL 32/160B (4-polig, 50 Hz)

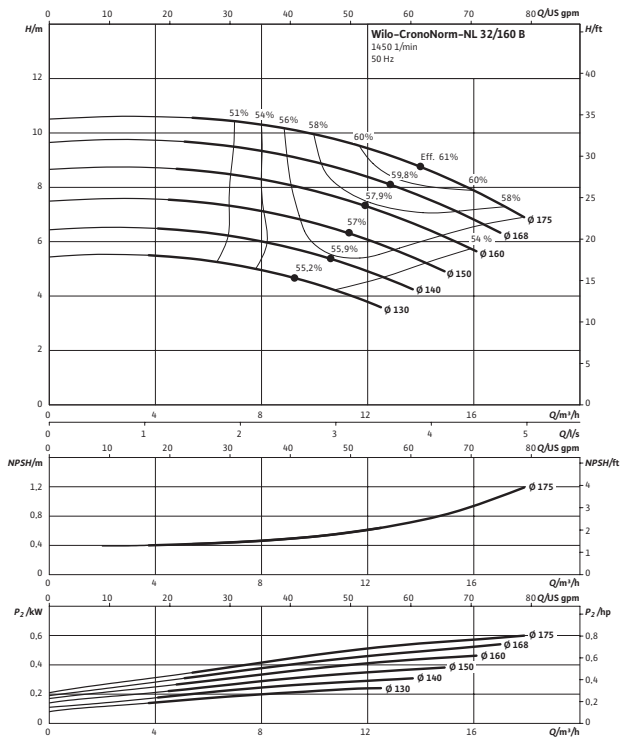

Kennlinien

CronoNorm-NL 32/200 (4-polig, 50 Hz)

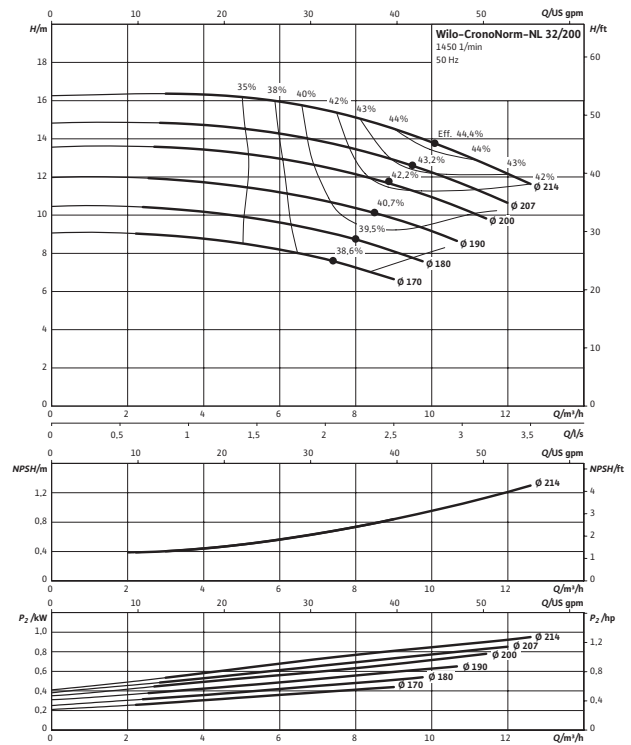

Kennlinien

CronoNorm-NL 32/200B (4-polig, 50 Hz)

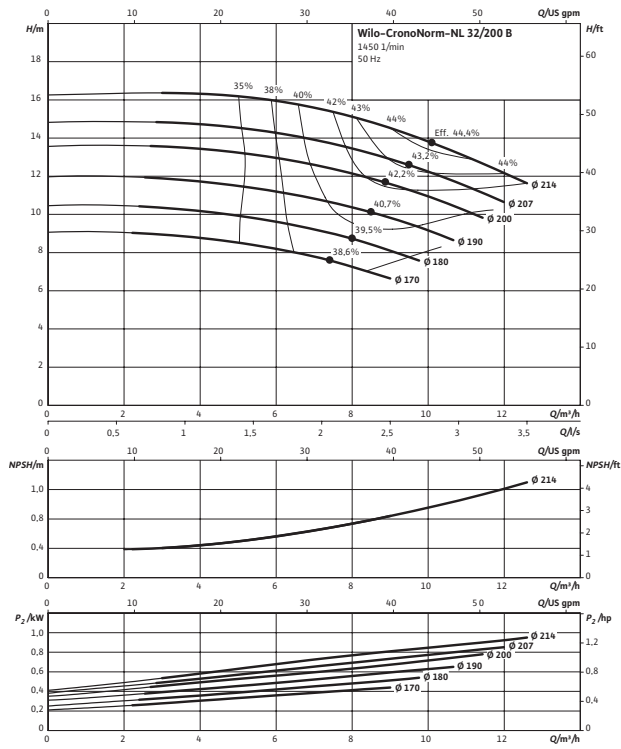

Kennlinien

CronoNorm-NL 32/250 (4-polig, 50 Hz)

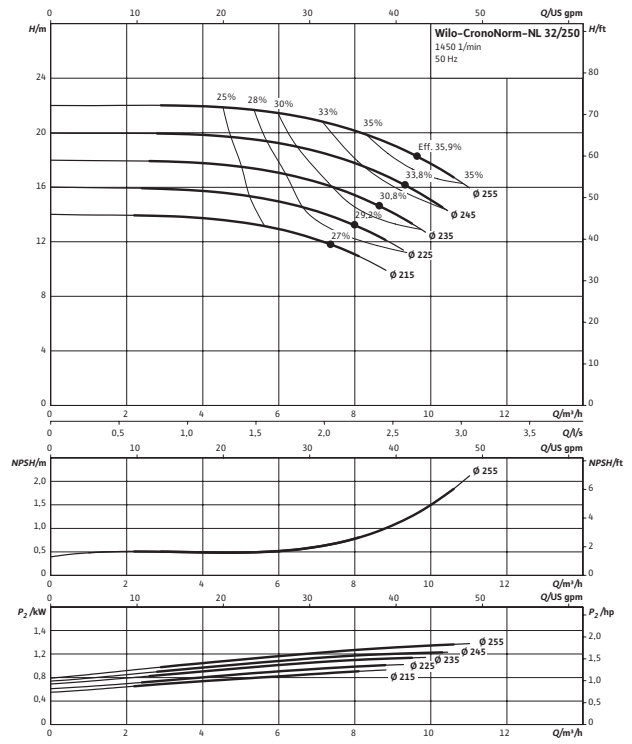

Kennlinien

CronoNorm-NL 40/125 (4-polig, 50 Hz)

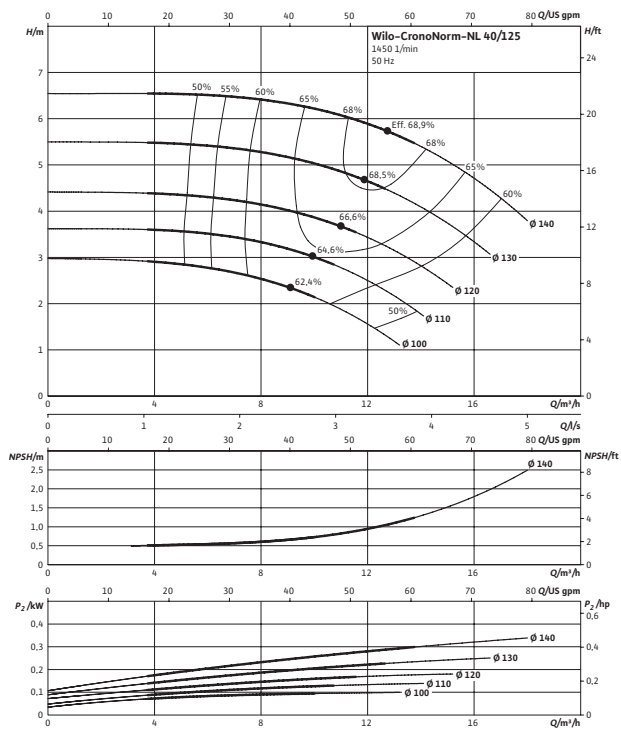

Kennlinien

CronoNorm-NL 40/160 (4-polig, 50 Hz)

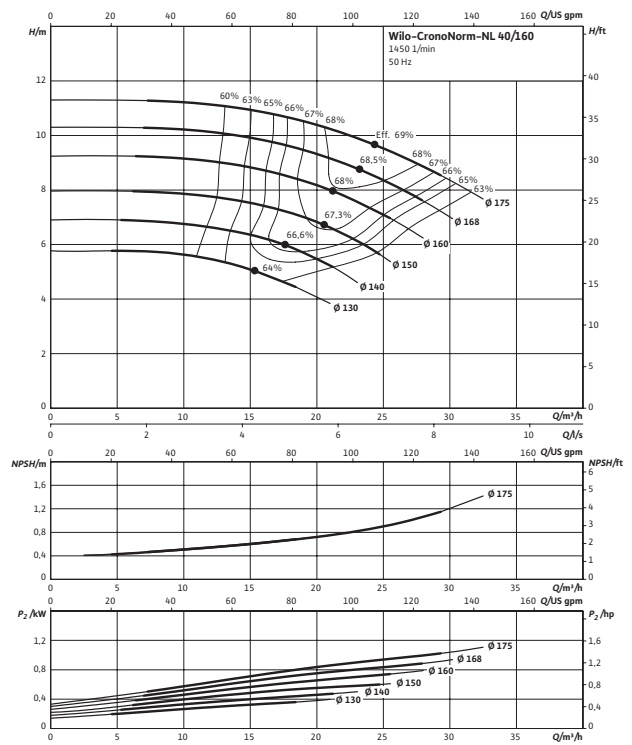

Heizung, Klima, Kälte;
Wasserversorgung

Kennlinien

CronoNorm-NL 40/200 (4-polig, 50 Hz)

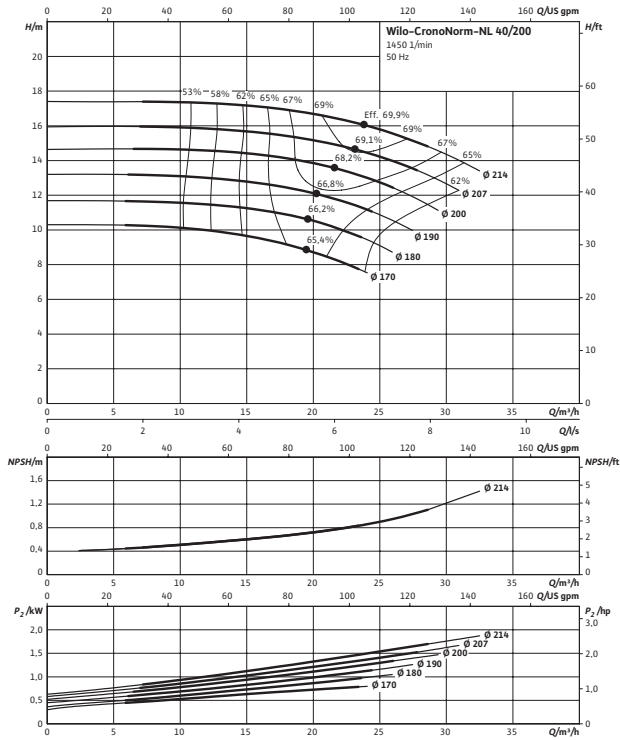

Kennlinien

CronoNorm-NL 40/250 (4-polig, 50 Hz)

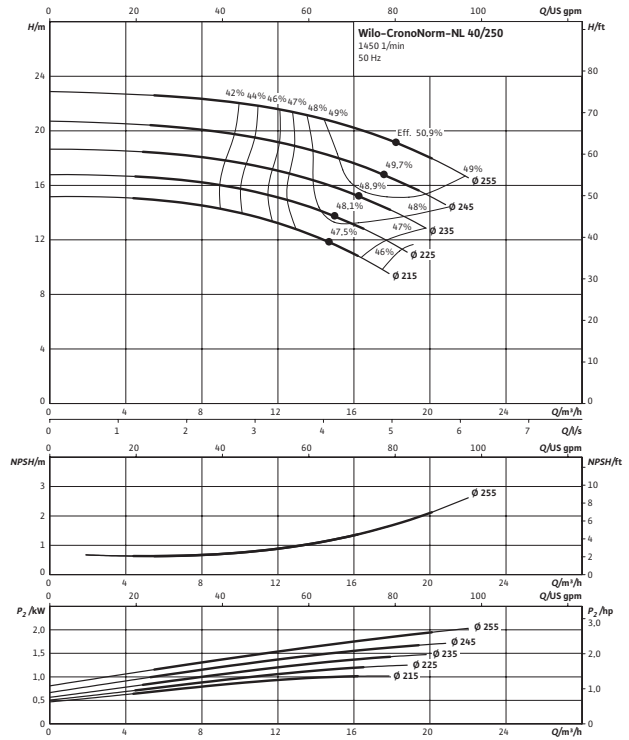

Kennlinien

CronoNorm-NL 40/315 (4-polig, 50 Hz)

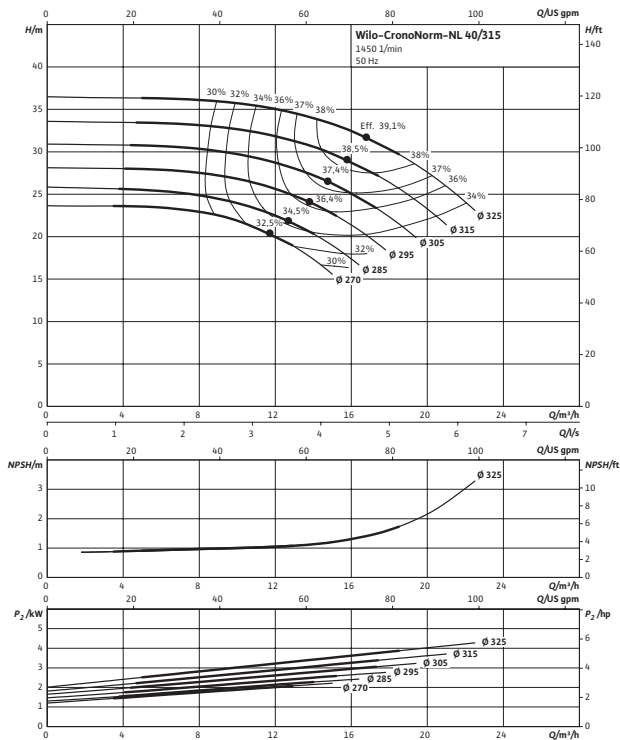

Kennlinien

CronoNorm-NL 50/125 (4-polig, 50 Hz)

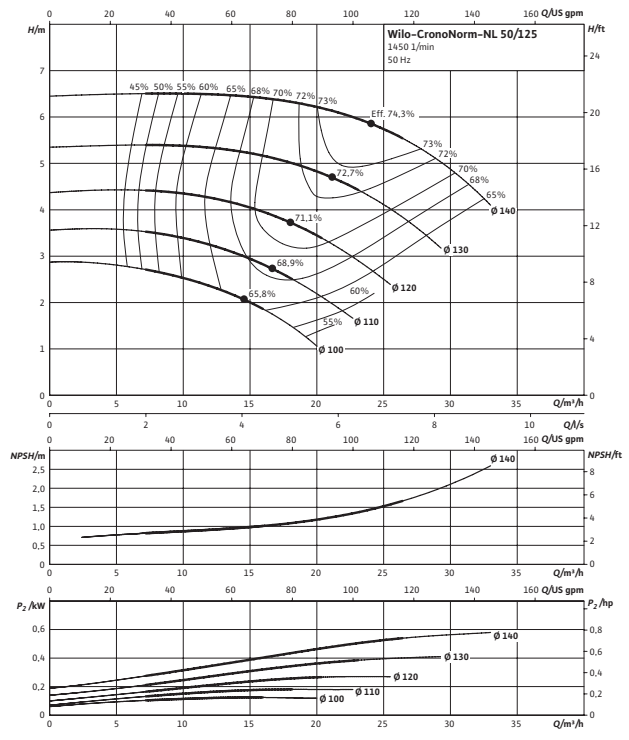

Kennlinien

CronoNorm-NL 50/160 (4-polig, 50 Hz)

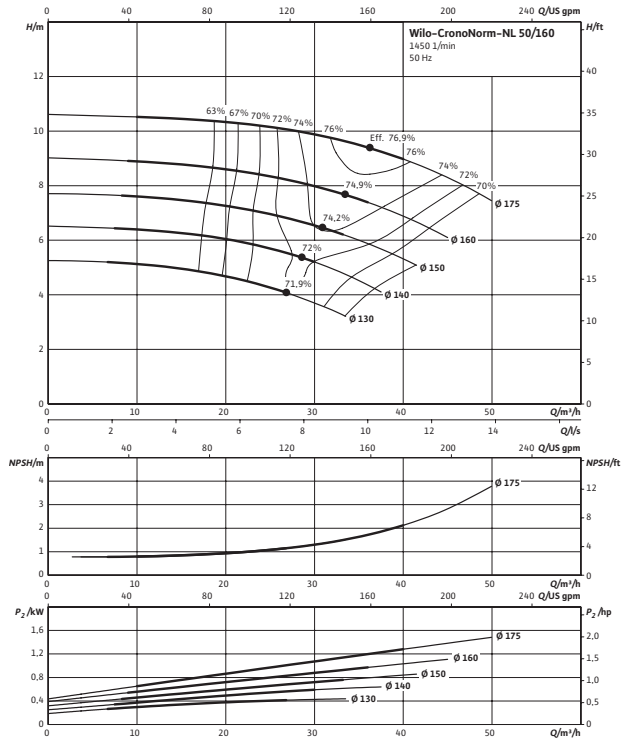

Kennlinien

CronoNorm-NL 50/200 (4-polig, 50 Hz)

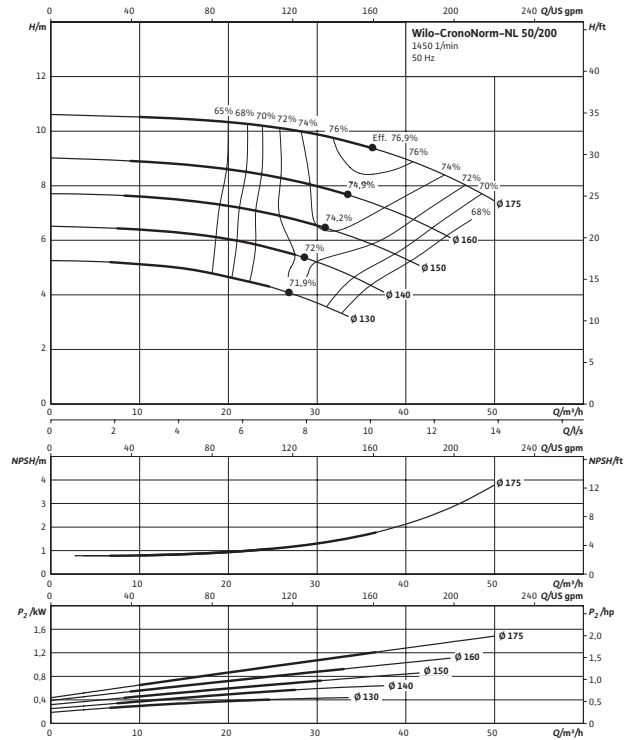

Kennlinien

CronoNorm-NL 50/250 (4-polig, 50 Hz)

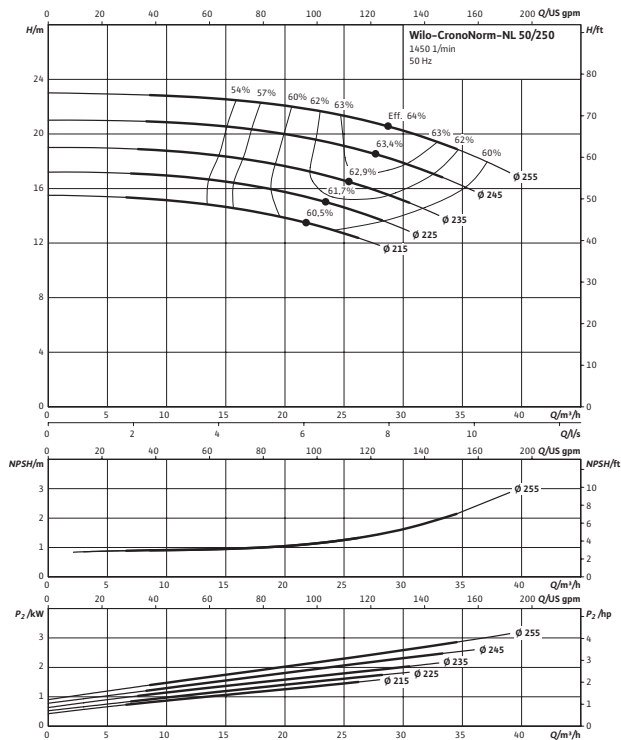

Kennlinien

CronoNorm-NL 50/315 (4-polig, 50 Hz)

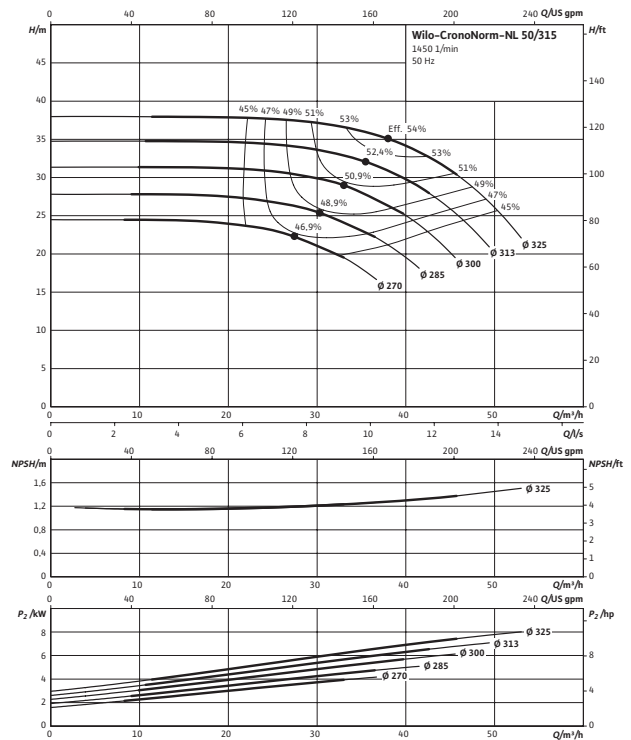

Kennlinien

CronoNorm-NL 65/125 (4-polig, 50 Hz)

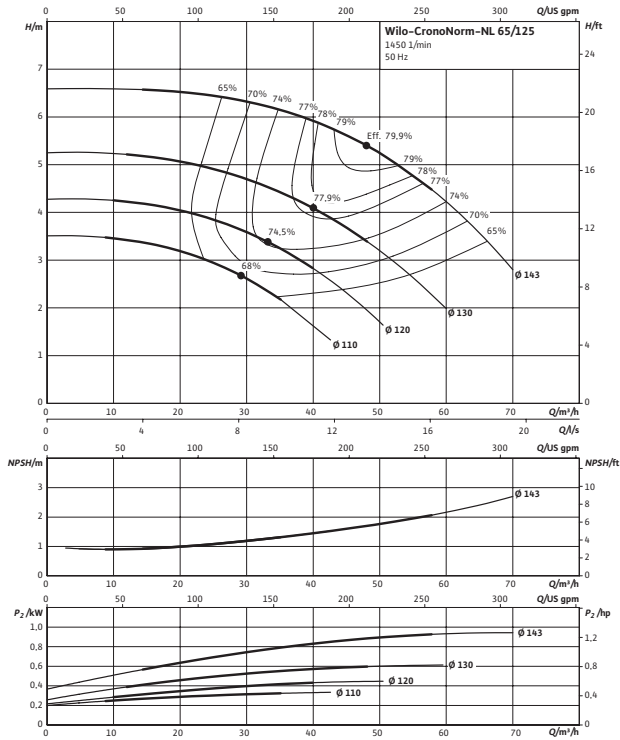

Kennlinien

CronoNorm-NL 65/160 (4-polig, 50 Hz)

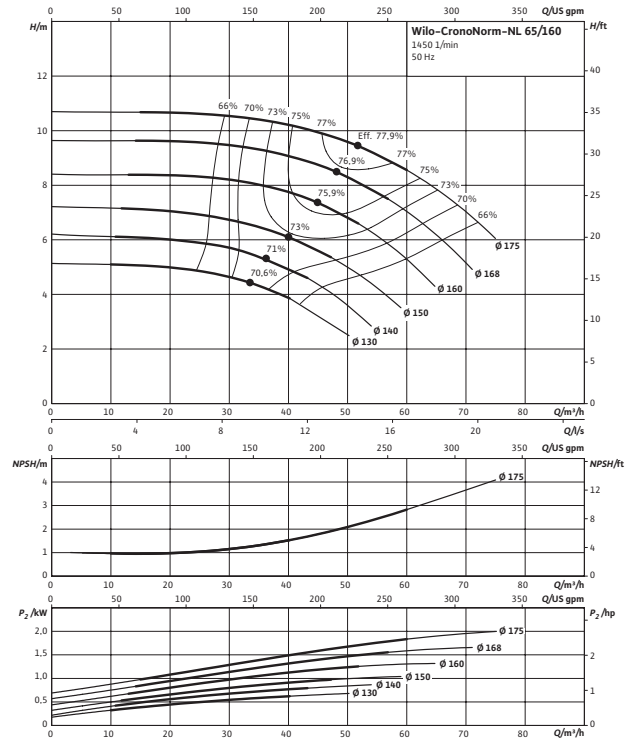

Kennlinien

CronoNorm-NL 65/200 (4-polig, 50 Hz)

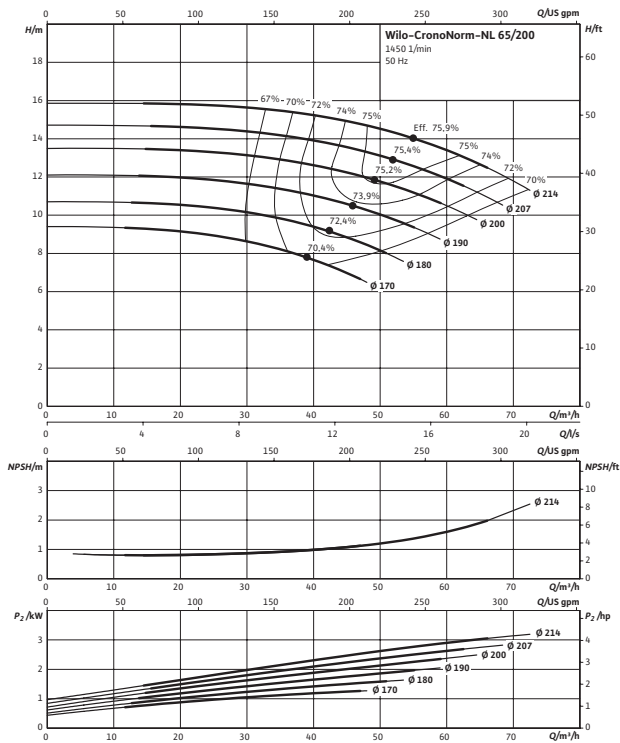

Kennlinien

CronoNorm-NL 65/250 (4-polig, 50 Hz)

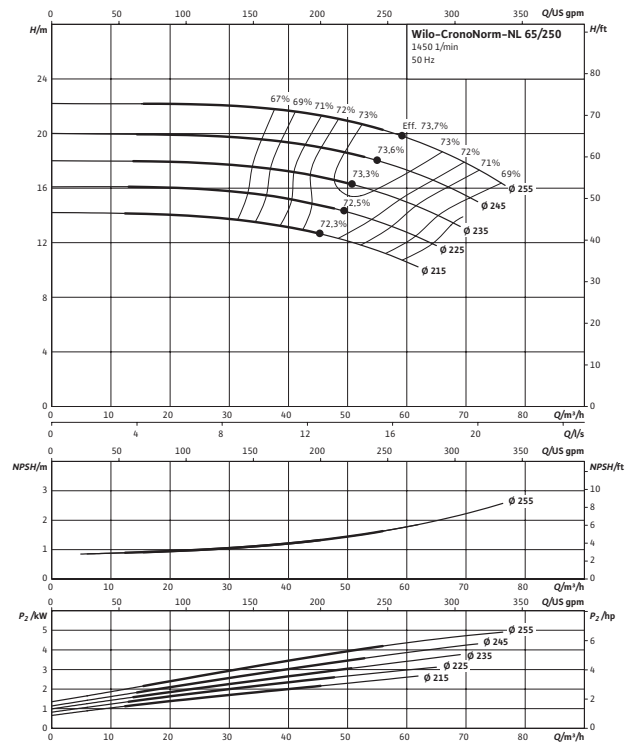

Kennlinien

CronoNorm-NL 65/315 (4-polig, 50 Hz)

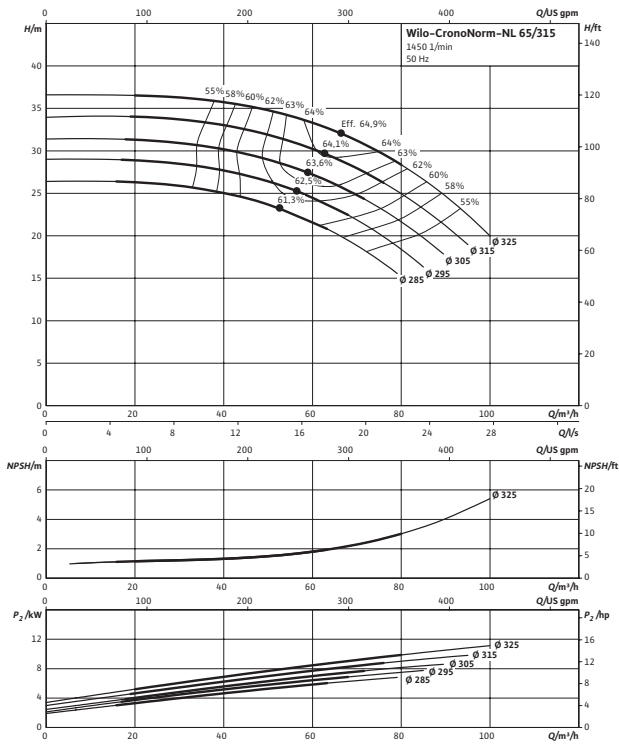

Kennlinien

CronoNorm-NL 80/160 (4-polig, 50 Hz)

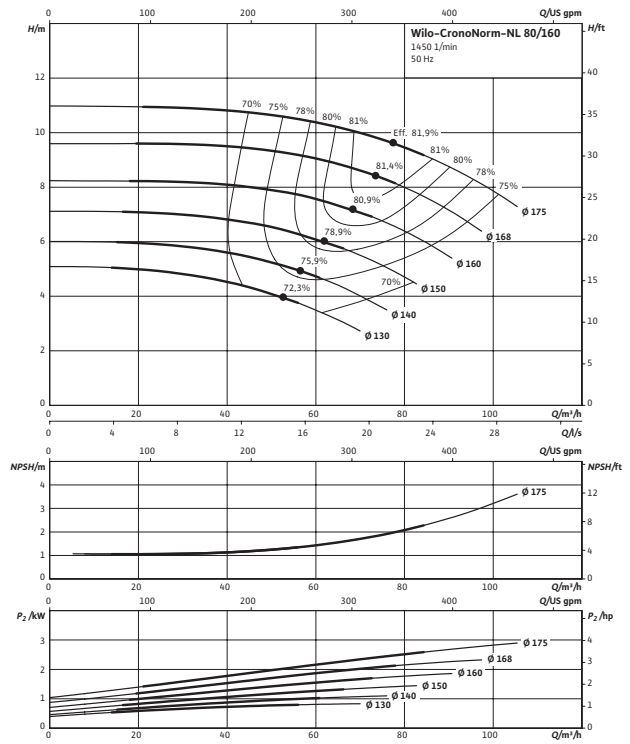

Kennlinien

CronoNorm-NL 80/200 (4-polig, 50 Hz)

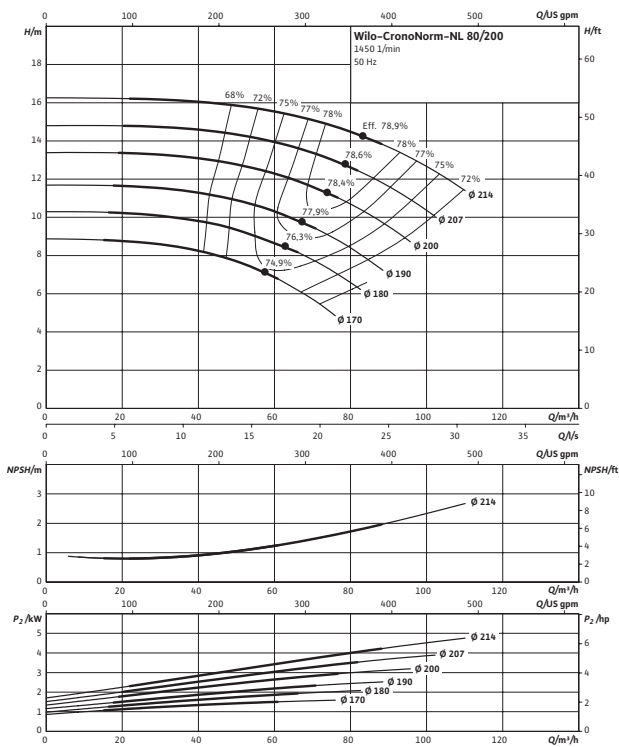

Kennlinien

CronoNorm-NL 80/250 (4-polig, 50 Hz)

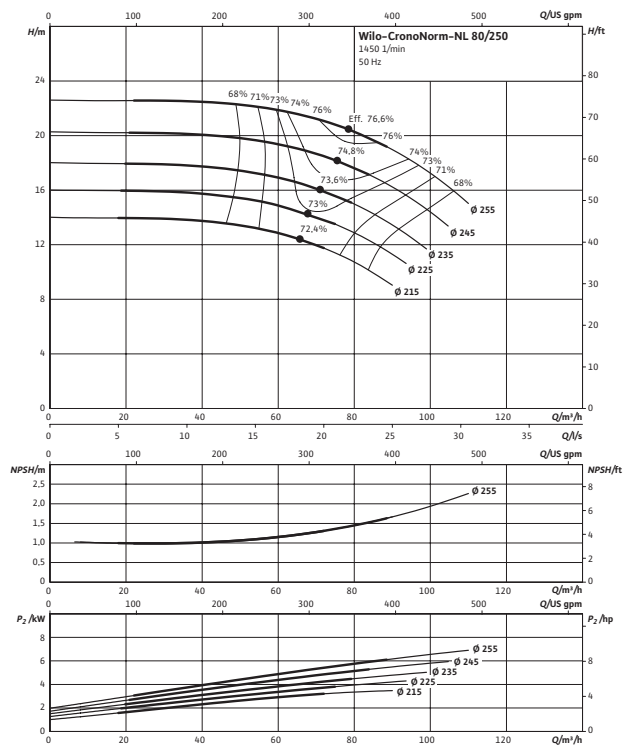

Heizung, Klima, Kälte;
Wasserversorgung

Kennlinien

CronoNorm-NL 80/315 (4-polig, 50 Hz)

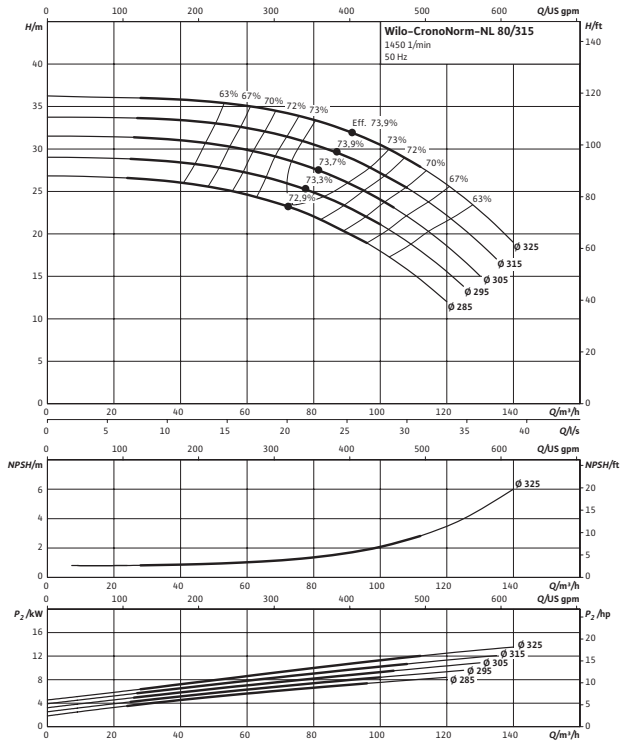

Kennlinien

CronoNorm-NL 80/400 (4-polig, 50 Hz)

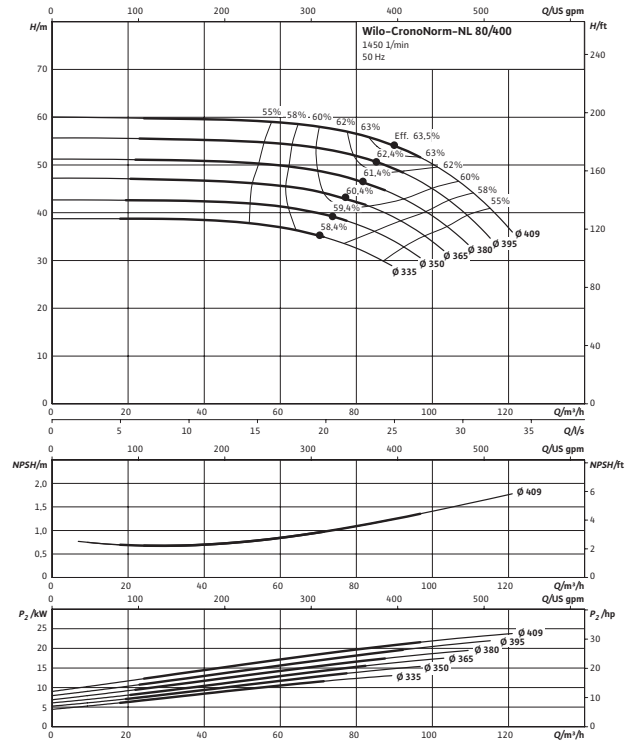

Kennlinien

CronoNorm-NL 100/160 (4-polig, 50 Hz)

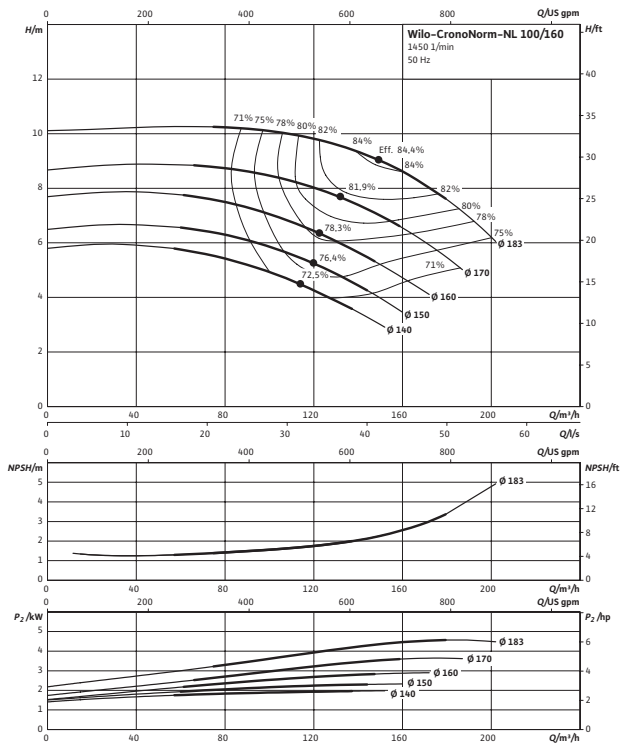

Kennlinien

CronoNorm-NL 100/200 (4-polig, 50 Hz)

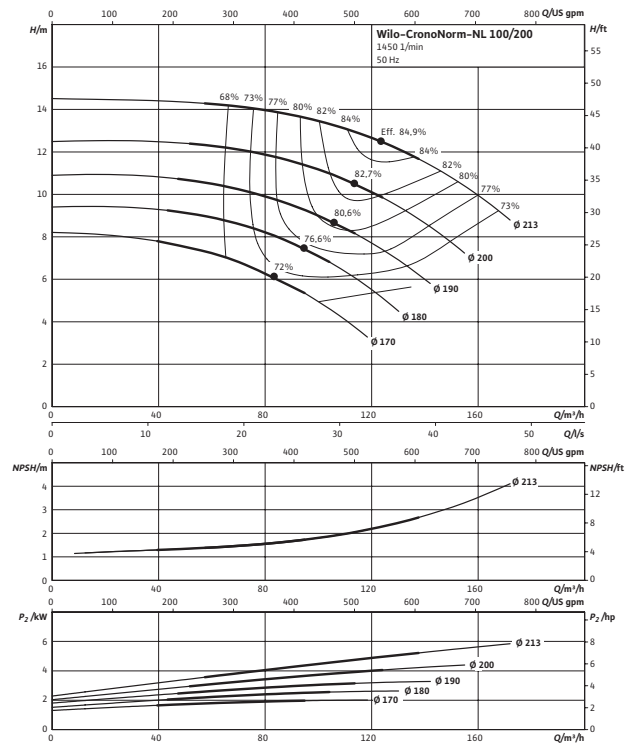

Kennlinien

CronoNorm-NL 100/250 (4-polig, 50 Hz)

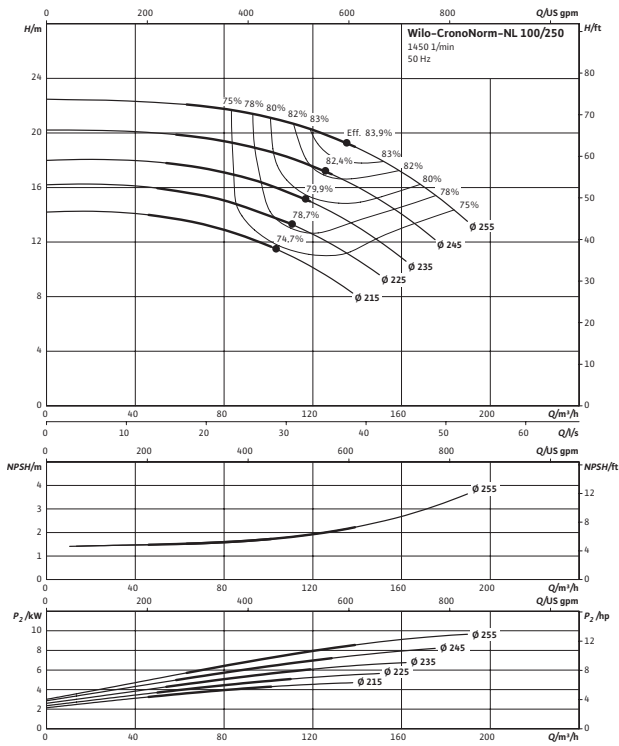

Kennlinien

CronoNorm-NL 100/315 (4-polig, 50 Hz)

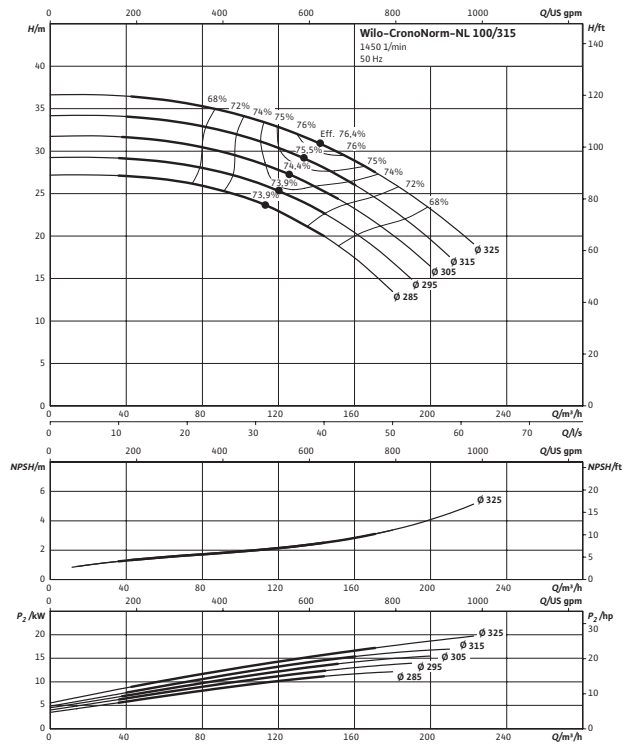

Kennlinien

CronoNorm-NL 100/400 (4-polig, 50 Hz)

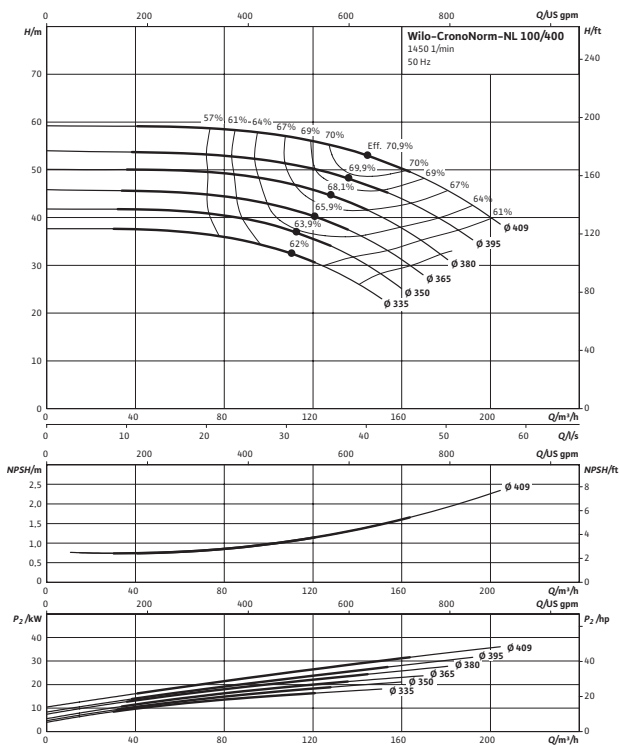

Kennlinien

CronoNorm-NL 125/200 (4-polig, 50 Hz)

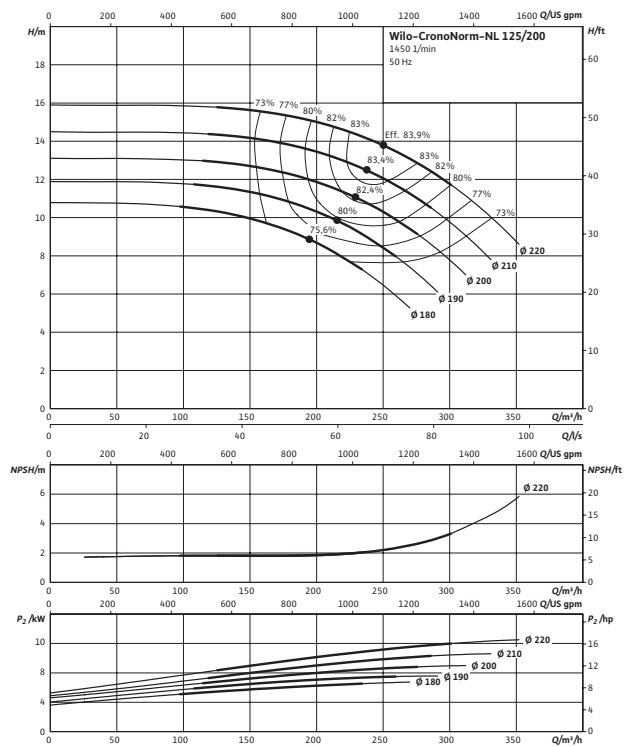

Heizung, Klima, Kälte;
Wasserversorgung

Kennlinien

CronoNorm-NL 125/250 (4-polig, 50 Hz)

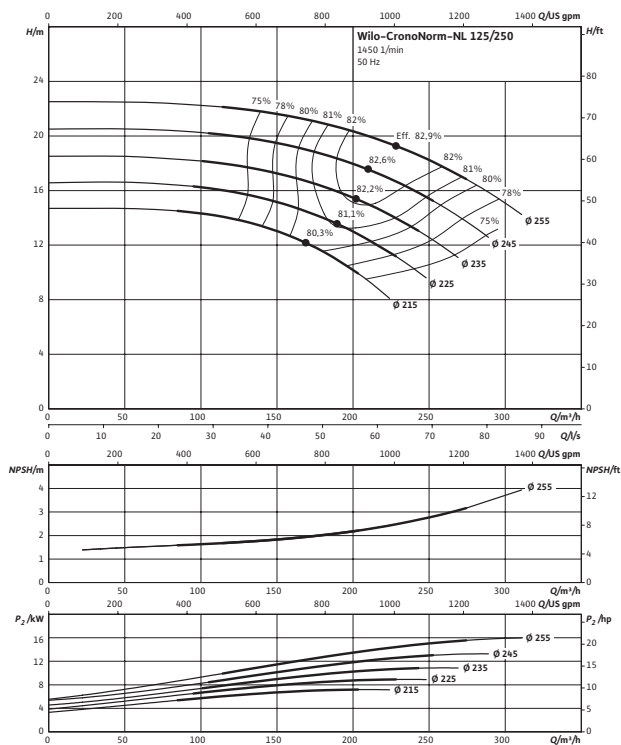

Kennlinien

CronoNorm-NL 125/315 (4-polig, 50 Hz)

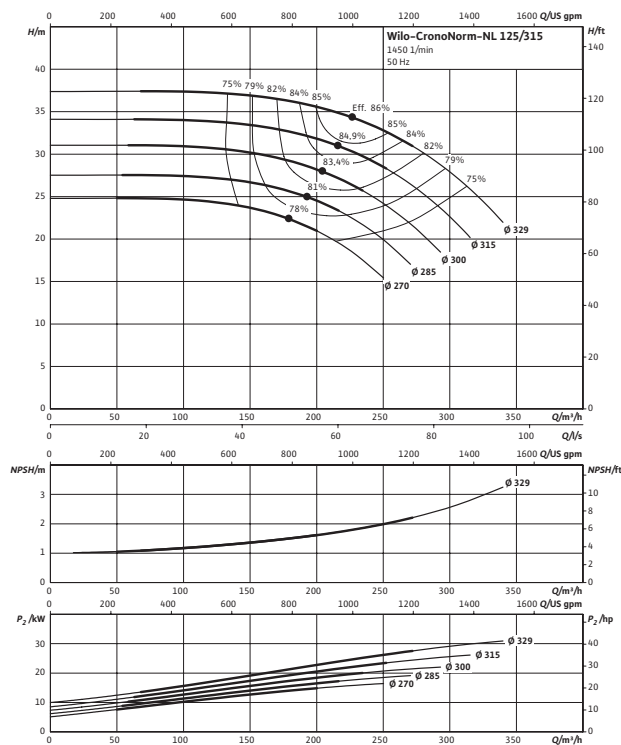

Kennlinien

CronoNorm-NL 125/400 (4-polig, 50 Hz)

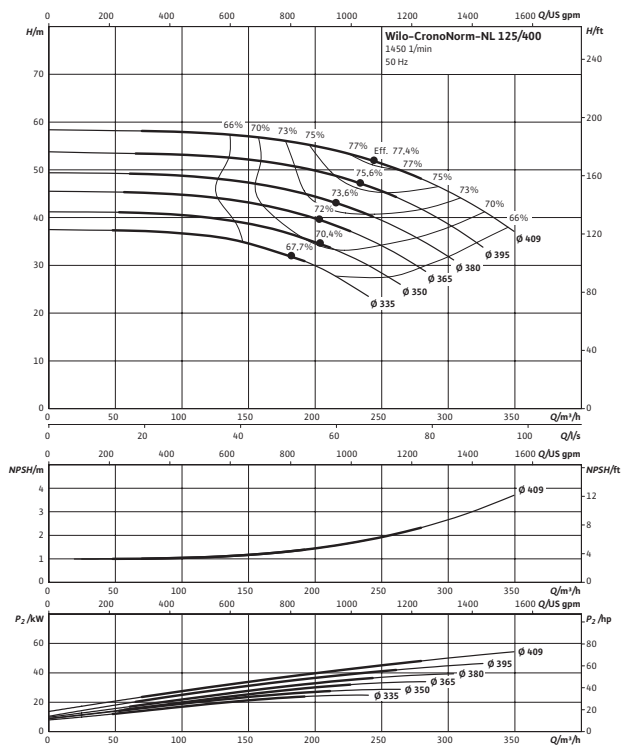

Kennlinien

CronoNorm-NL 150/200 (4-polig, 50 Hz)

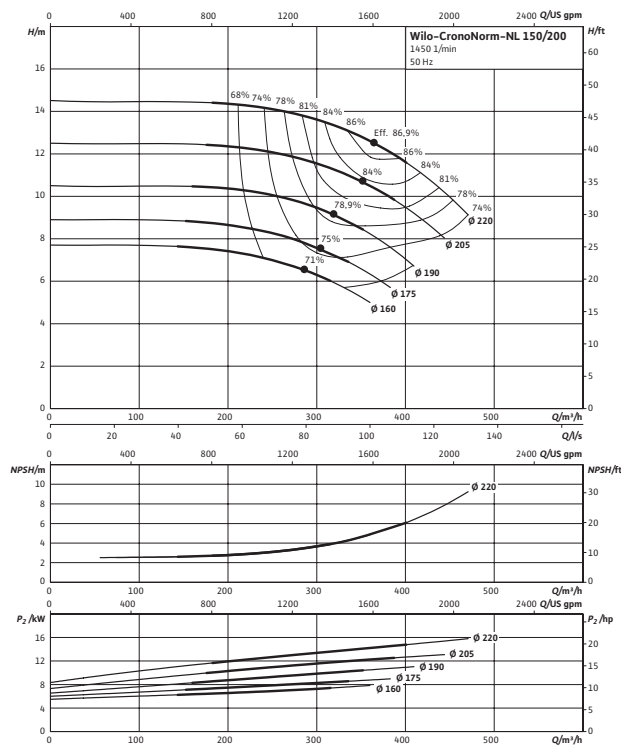

Kennlinien

CronoNorm-NL 150/250 (4-polig, 50 Hz)

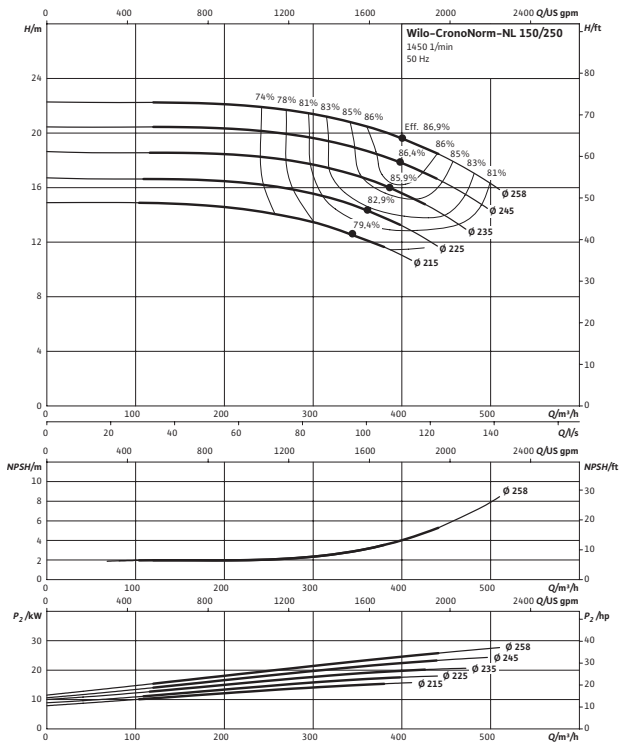

Kennlinien

CronoNorm-NL 150/315 (4-polig, 50 Hz)

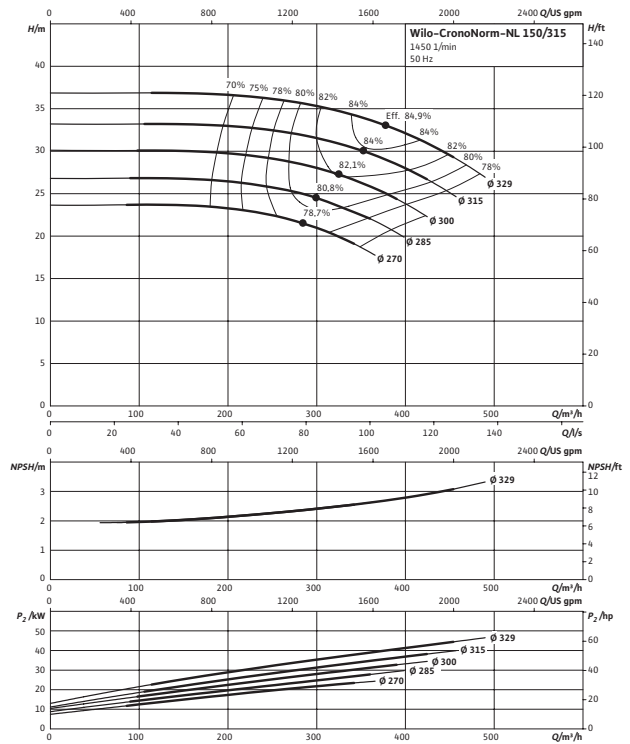

Kennlinien

CronoNorm-NL 150/400 (4-polig, 50 Hz)

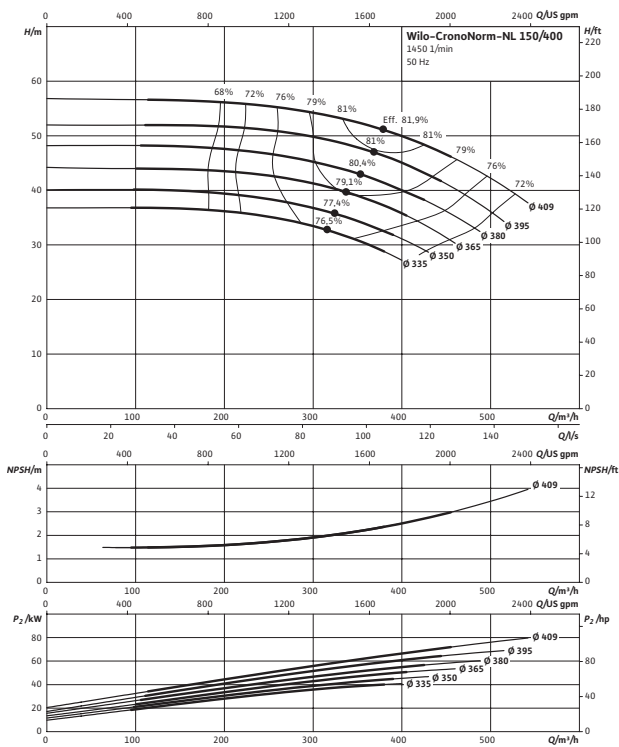

Heizung, Klima, Kälte;
Wasserversorgung

Maßzeichnung (mit Ausbaupumpung)

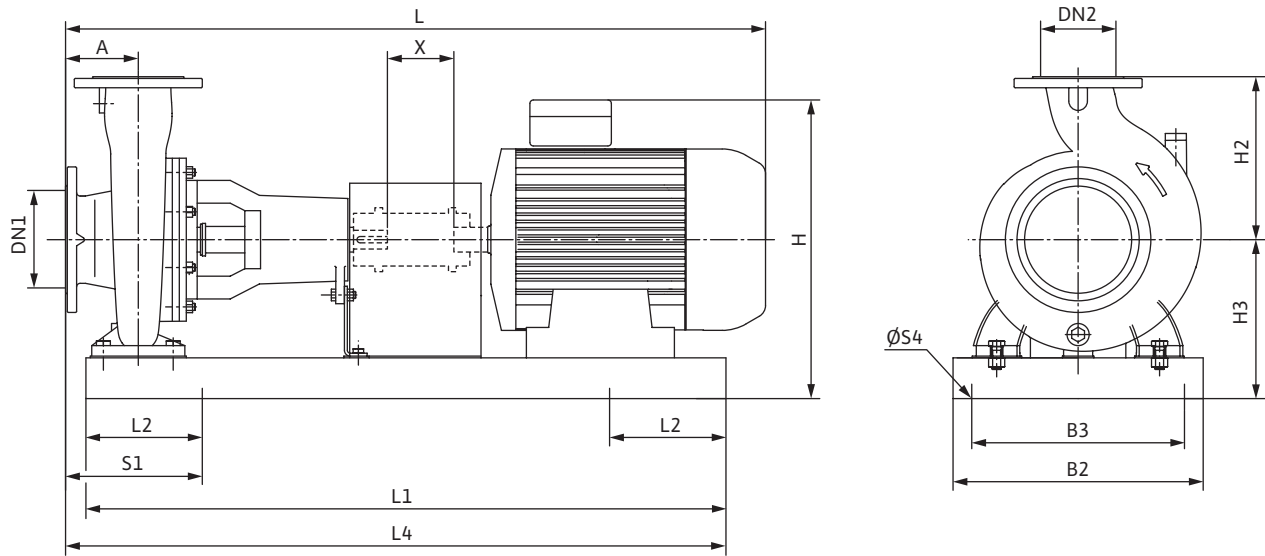

Maße, Gewichte (1450 1/min; mit Ausbaupumpung)

Wilo-Crono-Norm-NL...	Motor-nennleistung	Nennweite		Abmessungen														Gewicht netto ca.
		DN1	DN2	A	B2	B3	H	H2	H3	L	L1	L2	L4	S1	ØS4	X	m	
	P_2 kW										mm							kg
32/125	0,37	50	32	80	360	320	302	140	195	793	830	145	835	150	19	100	85	
32/160	0,37	50	32	80	360	320	322	160	215	793	830	145	835	150	19	100	97	
32/160	0,55	50	32	80	360	320	330	160	215	824	830	145	835	150	19	100	90	
32/160	0,75	50	32	80	360	320	355	160	215	816	830	145	835	150	19	100	98	
32/160B	0,37	50	32	80	360	320	322	160	215	793	830	145	835	150	19	100	97	
32/160B	0,55	50	32	80	360	320	330	160	215	824	830	145	835	150	19	100	90	
32/160B	0,75	50	32	80	360	320	355	160	215	816	830	145	835	150	19	100	98	
32/200	0,55	50	32	80	360	320	358	180	243	824	830	145	835	150	19	100	148	
32/200	0,75	50	32	80	360	320	383	180	243	816	830	145	835	150	19	100	100	
32/200	1,1	50	32	80	390	350	402	180	243	844	930	165	935	170	19	100	160	
32/200	1,5	50	32	80	390	350	402	180	243	869	930	165	935	170	19	100	156	
32/200B	0,55	50	32	80	360	320	358	180	243	824	830	145	835	150	19	100	93	
32/200B	0,75	50	32	80	360	320	383	180	243	816	830	145	835	150	19	100	100	
32/200B	1,1	50	32	80	390	350	402	180	243	844	930	165	935	170	19	100	160	
32/200B	1,5	50	32	80	390	350	402	180	243	869	930	165	935	170	19	100	156	
32/250	0,75	50	32	100	450	400	423	225	283	836	1030	185	1043	198	24	100	145	
32/250	1,1	50	32	100	450	400	442	225	283	864	1030	185	1043	198	24	100	151	
32/250	1,5	50	32	100	450	400	442	225	283	889	1030	185	1043	198	24	100	151	
32/250	2,2	50	32	100	450	400	452	225	283	936	1030	185	1043	198	24	100	162	

Maße, Gewichte (1450 1/min; mit Ausbaupumpung)

Wilo-Crono-Norm-NL...	Motor-nennleistung P_2 kW	Nennweite		Abmessungen													Gewicht netto ca. m kg
		DN1	DN2	A	B2	B3	H	H2	H3	L mm	L1	L2	L4	S1	ØS4	X	
40/125	0,37	65	40	80	360	320	302	140	195	793	830	145	835	150	19	100	82
40/125	0,55	65	40	80	360	320	310	140	195	824	830	145	835	150	19	100	84
40/160	0,37	65	40	80	360	320	322	160	215	793	830	145	835	150	19	100	94
40/160	0,55	65	40	80	360	320	330	160	215	824	830	145	835	150	19	100	87
40/160	0,75	65	40	80	360	320	355	160	215	816	830	145	835	150	19	100	95
40/160	1,1	65	40	80	360	320	374	160	215	844	830	145	835	150	19	100	101
40/160	1,5	65	40	80	390	350	374	160	215	869	930	165	935	170	19	100	111
40/200	0,55	65	40	100	390	350	358	180	243	844	930	165	955	190	19	100	105
40/200	0,75	65	40	100	390	350	383	180	243	836	930	165	955	190	19	100	113
40/200	1,1	65	40	100	390	350	402	180	243	864	930	165	955	190	19	100	124
40/200	1,5	65	40	100	390	350	402	180	243	889	930	165	955	190	19	100	124
40/200	2,2	65	40	100	390	350	412	180	243	936	930	165	955	190	19	100	135
40/250	1,1	65	40	100	450	400	442	225	283	864	1030	185	1043	198	24	100	151
40/250	1,5	65	40	100	450	400	442	225	283	889	1030	185	1043	198	24	100	151
40/250	2,2	65	40	100	450	400	452	225	283	936	1030	185	1043	198	24	100	162
40/250	3	65	40	100	450	400	452	225	283	980	1030	185	1043	198	24	100	165
40/315	2,2	65	40	125	490	440	497	250	328	1071	1150	205	1188	243	24	100	227
40/315	3	65	40	125	490	440	497	250	328	1115	1150	205	1188	243	24	100	230
40/315	4	65	40	125	490	440	520	250	328	1088	1150	205	1188	243	24	100	238
40/315	5,5	65	40	125	490	440	548	250	328	1147	1150	205	1188	243	24	100	263
50/125	0,37	65	50	100	360	320	322	160	215	813	830	145	855	170	19	100	94
50/125	0,55	65	50	100	360	320	330	160	215	844	830	145	855	170	19	100	87
50/125	0,75	65	50	100	360	320	355	160	215	836	830	145	855	170	19	100	95
50/160	0,55	65	50	100	390	350	358	180	243	844	930	165	955	190	19	100	105
50/160	0,75	65	50	100	390	350	383	180	243	836	930	165	955	190	19	100	113
50/160	1,1	65	50	100	390	350	402	180	243	864	930	165	955	190	19	100	124
50/160	1,5	65	50	100	390	350	402	180	243	889	930	165	955	190	19	100	124
50/160	2,2	65	50	100	390	350	412	180	243	936	930	165	955	190	19	100	135
50/200	1,1	65	50	100	390	350	402	200	243	864	930	165	955	190	19	100	128
50/200	1,5	65	50	100	390	350	402	200	243	889	930	165	955	190	19	100	128
50/200	2,2	65	50	100	390	350	412	200	243	936	930	165	955	190	19	100	139
50/200	3	65	50	100	390	350	412	200	243	980	930	165	955	190	19	100	142
50/250	1,5	65	50	100	450	400	442	225	283	889	1030	185	1043	198	24	100	155
50/250	2,2	65	50	100	450	400	452	225	283	936	1030	185	1043	198	24	100	166
50/250	3	65	50	100	450	400	452	225	283	980	1030	185	1043	198	24	100	169
50/250	4	65	50	100	450	400	475	225	283	953	1030	185	1043	198	24	100	173
50/315	4	65	50	125	490	440	520	280	328	1088	1150	205	1188	243	24	100	253
50/315	5,5	65	50	125	490	440	548	280	328	1147	1150	205	1188	243	24	100	278
50/315	7,5	65	50	125	490	440	510	280	328	1171	1150	205	1188	243	24	100	265
50/315	9	65	50	125	490	440	548	280	328	1210	1150	205	1188	243	24	100	303
65/125	0,55	80	65	100	390	350	358	180	243	844	930	165	943	178	19	100	102
65/125	0,75	80	65	100	390	350	383	180	243	836	930	165	943	178	19	100	109
65/125	1,1	80	65	100	450	400	422	180	263	864	1030	185	1043	198	24	100	133
65/160	0,75	80	65	100	390	350	383	200	243	836	930	165	943	178	19	100	116
65/160	1,5	80	65	100	390	350	402	200	243	889	930	165	943	178	19	100	127

Maße, Gewichte (1450 1/min; mit Ausbaupumpung)																		
Wilo-Crono-Norm-NL...	Motor-nennleistung	Nennweite		Abmessungen														Gewicht netto ca.
		DN1	DN2	A	B2	B3	H	H2	H3	L mm	L1	L2	L4	S1	ØS4	X	m kg	
65/160	2,2	80	65	100	390	350	412	200	243	936	930	165	943	178	19	100	138	
65/200	1,1	80	65	100	450	400	442	225	283	864	1030	185	1043	198	24	100	150	
65/200	1,5	80	65	100	450	400	442	225	283	889	1030	185	1043	198	24	100	150	
65/200	2,2	80	65	100	450	400	452	225	283	936	1030	185	1043	198	24	100	161	
65/200	3	80	65	100	450	400	452	225	283	980	1030	185	1043	198	24	100	164	
65/200	4	80	65	100	450	400	475	225	283	953	1030	185	1043	198	24	100	168	
65/250	2,2	80	65	100	490	440	472	250	303	1046	1150	205	1145	200	24	100	223	
65/250	3	80	65	100	490	440	472	250	303	1090	1150	205	1145	200	24	100	226	
65/250	4	80	65	100	490	440	495	250	303	1063	1150	205	1145	200	24	100	232	
65/250	5,5	80	65	100	490	440	523	250	303	1122	1150	205	1145	200	24	100	255	
65/315	5,5	80	65	125	540	490	548	280	328	1147	1290	225	1305	240	24	100	313	
65/315	7,5	80	65	125	540	490	510	280	328	1171	1290	225	1305	240	24	100	300	
65/315	9	80	65	125	540	490	548	280	328	1210	1290	225	1305	240	24	100	338	
65/315	11	80	65	125	540	490	528	280	328	1271	1290	225	1305	240	24	100	335	
65/315	15	80	65	125	610	550	528	280	328	1271	1440	250	1455	265	29	100	389	
80/160	1,1	100	80	125	450	400	442	225	283	929	1030	185	1068	223	24	140	148	
80/160	1,5	100	80	125	450	400	442	225	283	954	1030	185	1068	223	24	140	183	
80/160	2,2	100	80	125	450	400	452	225	283	1001	1030	185	1068	223	24	140	159	
80/160	3	100	80	125	450	400	452	225	283	1045	1030	185	1068	223	24	140	162	
80/160	4	100	80	125	450	400	475	225	283	1018	1030	185	1068	223	24	140	166	
80/200	1,5	100	80	125	490	440	442	250	283	1064	1150	205	1188	243	24	140	201	
80/200	2,2	100	80	125	490	440	452	250	283	1111	1150	205	1188	243	24	140	211	
80/200	3	100	80	125	490	440	452	250	283	1155	1150	205	1188	243	24	140	214	
80/200	4	100	80	125	490	440	475	250	283	1128	1150	205	1188	243	24	140	218	
80/200	5,5	100	80	125	490	440	503	250	283	1187	1150	205	1188	243	24	140	241	
80/250	3	100	80	125	540	490	472	280	303	1155	1290	225	1305	240	24	140	262	
80/250	4	100	80	125	540	490	495	280	303	1128	1290	225	1305	240	24	140	268	
80/250	5,5	100	80	125	540	490	523	280	303	1187	1290	225	1305	240	24	140	291	
80/250	7,5	100	80	125	540	490	485	280	303	1211	1290	225	1305	240	24	140	278	
80/315	5,5	100	80	125	540	490	573	315	353	1187	1290	225	1305	240	24	140	319	
80/315	7,5	100	80	125	540	490	535	315	353	1211	1290	225	1305	240	24	140	306	
80/315	9	100	80	125	540	490	573	315	353	1210	1290	225	1305	240	24	140	344	
80/315	11	100	80	125	540	490	553	315	353	1311	1290	225	1305	240	24	140	344	
80/315	15	100	80	125	540	490	553	315	353	1311	1290	225	1305	240	24	140	352	
80/400	11	125	80	125	610	550	583	355	383	1371	1440	250	1455	265	29	140	458	
80/400	15	125	80	125	610	550	583	355	383	1371	1440	250	1455	265	29	140	466	
80/400	18,5	125	80	125	610	550	655	355	383	1444	1440	250	1455	265	29	140	489	
80/400	22	125	80	125	610	550	655	355	383	1444	1440	250	1455	265	29	140	503	
80/400	30	125	80	125	610	550	644	355	383	1460	1440	250	1455	265	29	140	549	
100/160	2,2	125	100	125	490	440	472	280	303	1111	1150	205	1170	225	24	140	231	
100/160	3	125	100	125	490	440	472	280	303	1155	1150	205	1170	225	24	140	234	
100/160	4	125	100	125	490	440	495	280	303	1128	1150	205	1170	225	24	140	240	
100/160	5,5	125	100	125	490	440	523	280	303	1187	1150	205	1170	225	24	140	279	
100/200	2,2	125	100	125	490	440	472	280	303	1111	1150	205	1170	225	24	140	223	
100/200	3	125	100	125	490	440	472	280	303	1155	1150	205	1170	225	24	140	226	

Maße, Gewichte (1450 1/min; mit Ausbaupumpung)

Wilo-Crono-Norm-NL...	Motor-nennleistung P_2 kW	Nennweite		Abmessungen													Gewicht netto ca. m kg
		DN1	DN2	A	B2	B3	H	H2	H3	L mm	L1	L2	L4	S1	ØS4	X	
100/200	4	125	100	125	490	440	495	280	303	1128	1150	205	1170	225	24	140	232
100/200	5,5	125	100	125	490	440	523	280	303	1187	1150	205	1170	225	24	140	255
100/200	7,5	125	100	125	490	440	485	280	303	1211	1150	205	1170	225	24	140	242
100/250	4	125	100	140	540	490	520	280	328	1143	1290	225	1320	255	24	140	281
100/250	5,5	125	100	140	540	490	548	280	328	1202	1290	225	1320	255	24	140	306
100/250	7,5	125	100	140	540	490	510	280	328	1226	1290	225	1320	255	24	140	293
100/250	9	125	100	140	540	490	548	280	328	1265	1290	225	1320	255	24	140	331
100/250	11	125	100	140	540	490	528	280	328	1326	1290	225	1320	255	24	140	328
100/315	11	125	100	140	540	490	553	315	353	1326	1290	225	1320	255	24	140	354
100/315	15	125	100	140	540	490	553	315	353	1326	1290	225	1320	255	24	140	361
100/315	18,5	125	100	140	610	550	625	315	353	1399	1440	250	1470	280	29	140	430
100/315	22	125	100	140	610	550	625	315	353	1399	1440	250	1470	280	29	140	444
100/400	15	125	100	140	660	600	603	355	403	1386	1640	290	1650	300	29	140	518
100/400	18,5	125	100	140	660	600	675	355	403	1459	1640	290	1650	300	29	140	541
100/400	22	125	100	140	660	600	675	355	403	1459	1640	290	1650	300	29	140	555
100/400	30	125	100	140	660	600	664	355	403	1475	1640	290	1650	300	29	140	602
100/400	37	125	100	140	660	600	682	355	403	1575	1640	290	1650	300	29	140	643
100/400	45	125	100	140	660	600	682	355	403	1575	1640	290	1650	300	29	140	668
125/200	7,5	150	125	140	540	490	535	315	353	1226	1290	225	1320	255	24	140	311
125/200	9	150	125	140	540	490	573	315	353	1265	1290	225	1320	255	24	140	349
125/200	11	150	125	140	540	490	553	315	353	1326	1290	225	1320	255	24	140	349
125/200	15	150	125	140	540	490	553	315	353	1326	1290	225	1320	255	24	140	357
125/250	7,5	150	125	140	540	490	535	355	353	1226	1290	225	1320	255	24	140	313
125/250	9	150	125	140	540	490	573	355	353	1265	1290	225	1320	255	24	140	351
125/250	11	150	125	140	540	490	553	355	353	1326	1290	225	1320	255	24	140	351
125/250	15	150	125	140	610	550	553	355	353	1326	1440	250	1470	280	29	140	405
125/250	18,5	150	125	140	610	550	625	355	353	1399	1440	250	1470	280	29	140	428
125/315	15	150	125	140	660	600	603	355	403	1386	1640	290	1650	300	29	140	496
125/315	18,5	150	125	140	660	600	675	355	403	1459	1640	290	1650	300	29	140	520
125/315	22	150	125	140	660	600	675	355	403	1459	1640	290	1650	300	29	140	534
125/315	30	150	125	140	660	600	664	355	403	1475	1640	290	1650	300	29	140	580
125/315	37	150	125	140	660	600	682	355	403	1575	1640	290	1650	300	29	140	622
125/400	30	150	125	140	660	600	699	400	438	1475	1640	290	1650	300	29	140	624
125/400	37	150	125	140	660	600	717	400	438	1575	1640	290	1650	300	29	140	665
125/400	45	150	125	140	660	600	717	400	438	1575	1640	290	1650	300	29	140	690
125/400	55	150	125	140	660	600	840	400	438	1775	1640	290	1650	300	29	140	731
125/400	75	150	125	140	730	670	910	400	438	1881	1840	320	1850	330	29	140	1173
150/200	7,5	200	150	160	730	670	585	400	403	1246	1840	320	1870	350	29	140	519
150/200	9	200	150	160	730	670	623	400	403	1285	1840	320	1870	350	29	140	556
150/200	11	200	150	160	730	670	603	400	403	1346	1840	320	1870	350	29	140	560
150/200	15	200	150	160	730	670	603	400	403	1346	1840	320	1870	350	29	140	568
150/200	18,5	200	150	160	730	670	675	400	403	1419	1840	320	1870	350	29	140	591
150/250	15	200	150	160	660	600	603	400	403	1346	1640	290	1670	320	29	140	479
150/250	18,5	200	150	160	660	600	675	400	403	1419	1640	290	1670	320	29	140	502
150/250	22	200	150	160	660	600	675	400	403	1419	1640	290	1670	320	29	140	516

Heizung, Klima, Kälte;
Wasserversorgung

Maße, Gewichte (1450 1/min; mit Ausbaupumpung)																		
Wilo-Crono-Norm-NL...	Motor-nennleistung	Nennweite		Abmessungen														Gewicht netto ca.
		DN1	DN2	A	B2	B3	H	H2	H3	L mm	L1	L2	L4	S1	ØS4	X	m kg	
150/250	30	200	150	160	660	600	664	400	403	1435	1640	290	1670	320	29	140	563	
150/315	22	200	150	160	730	670	675	400	403	1479	1840	320	1870	350	29	140	642	
150/315	30	200	150	160	730	670	664	400	403	1495	1840	320	1870	350	29	140	688	
150/315	37	200	150	160	730	670	682	400	403	1595	1840	320	1870	350	29	140	730	
150/315	45	200	150	160	730	670	682	400	403	1595	1840	320	1870	350	29	140	755	
150/315	55	200	150	160	730	670	805	400	403	1795	1840	320	1870	350	29	140	796	
150/400	45	200	150	160	730	670	717	450	438	1595	1840	320	1870	350	29	140	815	
150/400	55	200	150	160	730	670	840	450	438	1795	1840	320	1870	350	29	140	855	
150/400	75	200	150	160	730	670	910	450	438	1901	1840	320	1870	350	29	140	1204	
150/400	90	200	150	160	730	670	910	450	438	1901	1840	320	1870	350	29	140	1275	

Maße, Gewichte (2900 1/min; mit Ausbaupumpung)																		
Wilo-Crono-Norm-NL...	Motor-nennleistung	Nennweite		Abmessungen														Gewicht netto ca.
		DN1	DN2	A	B2	B3	H	H2	H3	L mm	L1	L2	L4	S1	ØS4	X	m kg	
32/125	0,55	50	32	80	360	320	302	140	195	793	830	145	835	150	19	100	85	
32/125	0,75	50	32	80	360	320	335	140	195	816	830	145	835	150	19	100	92	
32/125	1,1	50	32	80	360	320	335	140	195	816	830	145	835	150	19	100	94	
32/125	1,5	50	32	80	360	320	354	140	195	844	830	145	835	150	19	100	97	
32/125	2,2	50	32	80	390	350	354	140	195	869	930	165	935	170	19	100	111	
32/160	1,5	50	32	80	360	320	374	160	215	844	830	145	835	150	19	100	100	
32/160	2,2	50	32	80	390	350	374	160	215	869	930	165	935	170	19	100	115	
32/160	3	50	32	80	390	350	384	160	215	916	930	165	935	170	19	100	127	
32/160	4	50	32	80	390	350	407	160	215	933	930	165	935	170	19	100	133	
32/160	5,5	50	32	80	390	350	435	160	215	992	930	165	935	170	19	100	153	
32/160B	1,5	50	32	80	360	320	374	160	215	844	830	145	835	150	19	100	100	
32/160B	2,2	50	32	80	390	350	374	160	215	869	930	165	935	170	19	100	115	
32/160B	3	50	32	80	390	350	384	160	215	916	930	165	935	170	19	100	127	
32/160B	4	50	32	80	390	350	407	160	215	933	930	165	935	170	19	100	133	
32/160B	5,5	50	32	80	390	350	435	160	215	992	930	165	935	170	19	100	153	
32/200	2,2	50	32	80	390	350	402	180	243	869	930	165	935	170	19	100	123	
32/200	3	50	32	80	390	350	412	180	243	916	930	165	935	170	19	100	133	
32/200	4	50	32	80	390	350	435	180	243	933	930	165	935	170	19	100	137	
32/200	5,5	50	32	80	390	350	463	180	243	992	930	165	935	170	19	100	158	
32/200	7,5	50	32	80	390	350	425	180	243	1016	930	165	935	170	19	100	149	
32/200	9	50	32	80	390	350	463	180	243	1030	930	165	935	170	19	100	173	
32/200	11	50	32	80	450	400	463	180	263	1116	1030	185	1035	190	24	100	206	
32/200B	2,2	50	32	80	390	350	402	180	243	869	930	165	935	170	19	100	123	
32/200B	3	50	32	80	390	350	412	180	243	916	930	165	935	170	19	100	133	
32/200B	4	50	32	80	390	350	435	180	243	933	930	165	935	170	19	100	137	
32/200B	5,5	50	32	80	390	350	463	180	243	992	930	165	935	170	19	100	158	
32/200B	7,5	50	32	80	390	350	425	180	243	1016	930	165	935	170	19	100	149	
32/200B	9	50	32	80	390	350	463	180	243	1030	930	165	935	170	19	100	173	

Maße, Gewichte (2900 1/min; mit Ausbaupumpung)																		
Wilo-Crono-Norm-NL...	Motor-nennleistung	Nennweite		Abmessungen														Gewicht netto ca.
		DN1	DN2	A	B2	B3	H	H2	H3	L mm	L1	L2	L4	S1	ØS4	X	m kg	
32/200B	11	50	32	80	450	400	463	180	263	1116	1030	185	1035	190	24	100	206	
32/250	7,5	50	32	100	450	400	465	225	283	1036	1030	185	1043	198	24	100	176	
32/250	9	50	32	100	450	400	503	225	283	1050	1030	185	1043	198	24	100	200	
32/250	11	50	32	100	450	400	483	225	283	1136	1030	185	1043	198	24	100	207	
32/250	15	50	32	100	450	400	483	225	283	1136	1030	185	1043	198	24	100	204	
40/125	1,1	65	40	80	360	320	335	140	195	816	830	145	835	150	19	100	89	
40/125	1,5	65	40	80	360	320	354	140	195	844	830	145	835	150	19	100	94	
40/125	2,2	65	40	80	390	350	354	140	195	869	930	165	935	170	19	100	109	
40/125	3	65	40	80	390	350	364	140	195	916	930	165	935	170	19	100	120	
40/160	2,2	65	40	80	390	350	374	160	215	869	930	165	935	170	19	100	109	
40/160	3	65	40	80	390	350	384	160	215	916	930	165	935	170	19	100	124	
40/160	4	65	40	80	390	350	407	160	215	933	930	165	935	170	19	100	130	
40/160	5,5	65	40	80	390	350	435	160	215	992	930	165	935	170	19	100	150	
40/160	7,5	65	40	80	390	350	397	160	215	1016	930	165	935	170	19	100	142	
40/160	9	65	40	80	390	350	435	160	215	1030	930	165	935	170	19	100	165	
40/200	5,5	65	40	100	390	350	463	180	243	1012	930	165	955	190	19	100	160	
40/200	7,5	65	40	100	390	350	425	180	243	1036	930	165	955	190	19	100	151	
40/200	9	65	40	100	390	350	463	180	243	1050	930	165	955	190	19	100	175	
40/200	11	65	40	100	450	400	463	180	263	1136	1030	185	1055	210	24	100	193	
40/200	15	65	40	100	450	400	463	180	263	1136	1030	185	1055	210	24	100	190	
40/200	18,5	65	40	100	490	440	463	180	263	1136	1150	205	1175	230	24	100	234	
40/250	7,5	65	40	100	450	400	465	225	283	1036	1030	185	1043	198	24	100	176	
40/250	9	65	40	100	450	400	503	225	283	1050	1030	185	1043	198	24	100	200	
40/250	11	65	40	100	450	400	483	225	283	1136	1030	185	1043	198	24	100	207	
40/250	15	65	40	100	450	400	483	225	283	1136	1030	185	1043	198	24	100	204	
40/250	18,5	65	40	100	490	440	483	225	283	1136	1150	205	1163	218	24	100	249	
40/315	15	65	40	125	540	490	528	250	328	1271	1290	225	1323	258	24	100	317	
40/315	18,5	65	40	125	540	490	528	250	328	1271	1290	225	1323	258	24	100	319	
40/315	22	65	40	125	540	490	600	250	328	1344	1290	225	1323	258	24	100	333	
40/315	30	65	40	125	540	490	589	250	328	1360	1290	225	1323	258	24	100	375	
40/315	37	65	40	125	540	490	589	250	328	1360	1290	225	1323	258	24	100	402	
50/125	1,5	65	50	100	360	320	374	160	215	844	830	145	855	170	19	100	97	
50/125	2,2	65	50	100	390	350	374	160	215	889	930	165	955	190	19	100	109	
50/125	3	65	50	100	390	350	384	160	215	936	930	165	955	190	19	100	124	
50/125	4	65	50	100	390	350	407	160	215	953	930	165	955	190	19	100	130	
50/125	5,5	65	50	100	390	350	435	160	215	1012	930	165	955	190	19	100	150	
50/160	3	65	50	100	390	350	412	180	243	936	930	165	955	190	19	100	135	
50/160	4	65	50	100	390	350	435	180	243	953	930	165	955	190	19	100	140	
50/160	5,5	65	50	100	390	350	463	180	243	1012	930	165	955	190	19	100	160	
50/160	7,5	65	50	100	390	350	425	180	243	1036	930	165	955	190	19	100	151	
50/160	9	65	50	100	390	350	463	180	243	1050	930	165	955	190	19	100	175	
50/160	11	65	50	100	450	400	463	180	263	1136	1030	185	1055	210	24	100	193	
50/160	15	65	50	100	450	400	463	180	263	1136	1030	185	1055	210	24	100	202	
50/200	7,5	65	50	100	390	350	425	200	243	1036	930	165	955	190	19	100	155	
50/200	9	65	50	100	390	350	463	200	243	1050	930	165	955	190	19	100	179	

Maße, Gewichte (2900 1/min; mit Ausbaupumpung)																	
Wilo-Crono-Norm-NL...	Motor-nennleistung P_2 kW	Nennweite		Abmessungen													Gewicht netto ca. m kg
		DN1	DN2	A	B2	B3	H	H2	H3	L mm	L1	L2	L4	S1	ØS4	X	
50/200	11	65	50	100	450	400	463	200	263	1136	1030	185	1055	210	24	100	197
50/200	15	65	50	100	450	400	463	200	263	1136	1030	185	1055	210	24	100	206
50/200	18,5	65	50	100	490	440	463	200	263	1136	1150	205	1175	230	24	100	241
50/200	22	65	50	100	490	440	555	200	283	1271	1150	205	1175	230	24	100	263
50/250	11	65	50	100	450	400	483	225	283	1136	1030	185	1043	198	24	100	211
50/250	15	65	50	100	450	400	483	225	283	1136	1030	185	1043	198	24	100	220
50/250	18,5	65	50	100	490	440	483	225	283	1136	1150	205	1163	218	24	100	256
50/250	22	65	50	100	490	440	555	225	283	1209	1150	205	1163	218	24	100	269
50/250	30	65	50	100	540	490	564	225	303	1225	1290	225	1298	233	24	100	351
50/315	15	65	50	125	540	490	528	280	328	1271	1290	225	1323	258	24	100	333
50/315	18,5	65	50	125	540	490	528	280	328	1271	1290	225	1323	258	24	100	334
50/315	22	65	50	125	540	490	600	280	328	1344	1290	225	1323	258	24	100	348
50/315	30	65	50	125	540	490	589	280	328	1360	1290	225	1323	258	24	100	391
50/315	37	65	50	125	540	490	589	280	328	1360	1290	225	1323	258	24	100	418
50/315	45	65	50	125	610	550	607	280	328	1430	1440	250	1473	283	29	100	514
50/315	55	65	50	125	610	550	755	280	353	1660	1440	250	1473	283	29	100	559
50/315	75	65	50	125	730	670	875	280	403	1766	1840	320	1873	353	29	100	1079
65/125	3	80	65	100	390	350	412	180	243	936	930	165	943	178	19	100	132
65/125	4	80	65	100	390	350	435	180	243	953	930	165	943	178	19	100	136
65/125	5,5	80	65	100	390	350	463	180	243	1012	930	165	943	178	19	100	157
65/125	7,5	80	65	100	390	350	425	180	243	1036	930	165	943	178	19	100	148
65/125	9	80	65	100	450	400	483	180	263	1050	1030	185	1043	198	24	100	188
65/160	5,5	80	65	100	390	350	463	200	243	1012	930	165	943	178	19	100	163
65/160	7,5	80	65	100	390	350	425	200	243	1036	930	165	943	178	19	100	154
65/160	9	80	65	100	450	400	483	200	263	1050	1030	185	1043	198	24	100	194
65/160	11	80	65	100	450	400	463	200	263	1136	1030	185	1043	198	24	100	196
65/160	15	80	65	100	450	400	463	200	263	1136	1030	185	1043	198	24	100	205
65/160	18,5	80	65	100	490	440	463	200	263	1136	1150	205	1163	218	24	100	240
65/200	9	80	65	100	450	400	503	225	283	1050	1030	185	1043	198	24	100	199
65/200	11	80	65	100	490	440	483	225	283	1136	1150	205	1163	218	24	100	240
65/200	15	80	65	100	490	440	483	225	283	1136	1150	205	1163	218	24	100	249
65/200	18,5	80	65	100	490	440	483	225	283	1136	1150	205	1163	218	24	100	251
65/200	22	80	65	100	490	440	555	225	283	1209	1150	205	1163	218	24	100	264
65/200	30	80	65	100	540	490	564	225	303	1225	1290	225	1298	233	24	100	346
65/250	18,5	80	65	100	540	490	503	250	303	1246	1290	225	1280	215	24	100	311
65/250	22	80	65	100	540	490	575	250	303	1319	1290	225	1280	215	24	100	325
65/250	30	80	65	100	610	550	564	250	303	1335	1440	250	1430	240	29	100	414
65/250	37	80	65	100	610	550	564	250	303	1335	1440	250	1430	240	29	100	441
65/250	45	80	65	100	610	550	607	250	328	1405	1440	250	1430	240	29	100	504
80/160	7,5	100	80	125	450	400	465	225	283	1101	1030	185	1068	223	24	140	173
80/160	9	100	80	125	450	400	503	225	283	1115	1030	185	1068	223	24	140	197
80/160	11	100	80	125	490	440	483	225	283	1201	1150	205	1188	243	24	140	238
80/160	15	100	80	125	490	440	483	225	283	1201	1150	205	1188	243	24	140	248
80/160	18,5	100	80	125	490	440	483	225	283	1201	1150	205	1188	243	24	140	249
80/160	22	100	80	125	490	440	555	225	283	1274	1150	205	1188	243	24	140	262

Maße, Gewichte (2900 1/min; mit Ausbaupumpung)																		
Wilo-Crono-Norm-NL...	Motor-nennleistung	Nennweite		Abmessungen														Gewicht netto ca.
		DN1	DN2	A	B2	B3	H	H2	H3	L mm	L1	L2	L4	S1	ØS4	X	m kg	
80/160	30	100	80	125	540	490	564	225	303	1290	1290	225	1323	258	24	140	345	
80/200	15	100	80	125	540	490	483	250	283	1311	1290	225	1323	258	24	140	296	
80/200	18,5	100	80	125	540	490	483	250	283	1311	1290	225	1323	258	24	140	297	
80/200	22	100	80	125	540	490	555	250	283	1384	1290	225	1323	258	24	140	311	
80/200	30	100	80	125	610	550	564	250	303	1400	1440	250	1473	283	29	140	407	
80/200	37	100	80	125	610	550	564	250	303	1400	1440	250	1473	283	29	140	434	
80/200	45	100	80	125	610	550	607	250	328	1470	1440	250	1473	283	29	140	497	
80/250	22	100	80	125	540	490	575	280	303	1384	1290	225	1305	240	24	140	330	
80/250	30	100	80	125	610	550	564	280	303	1400	1440	250	1455	265	29	140	419	
80/250	37	100	80	125	610	550	564	280	303	1400	1440	250	1455	265	29	140	446	
80/250	45	100	80	125	610	550	607	280	328	1470	1440	250	1455	265	29	140	509	
80/250	55	100	80	125	610	550	755	280	353	1700	1440	250	1455	265	29	140	557	
100/160	18,5	125	100	125	540	490	503	280	303	1311	1290	225	1305	240	24	140	320	
100/160	22	125	100	125	540	490	575	280	303	1384	1290	225	1305	240	24	140	333	
100/160	30	125	100	125	610	550	564	280	303	1400	1440	250	1455	265	29	140	422	
100/160	37	125	100	125	610	550	564	280	303	1400	1440	250	1455	265	29	140	449	
100/200	18,5	125	100	125	540	490	503	280	303	1311	1290	225	1305	240	24	140	311	
100/200	22	125	100	125	540	490	575	280	303	1384	1290	225	1305	240	24	140	325	
100/200	30	125	100	125	610	550	564	280	303	1400	1440	250	1455	265	29	140	414	
100/200	37	125	100	125	610	550	564	280	303	1400	1440	250	1455	265	29	140	441	
100/200	45	125	100	125	610	550	607	280	328	1470	1440	250	1455	265	29	140	504	
100/250	30	125	100	140	610	550	589	280	328	1415	1440	250	1470	280	29	140	434	
100/250	37	125	100	140	610	550	589	280	328	1415	1440	250	1470	280	29	140	461	
100/250	45	125	100	140	610	550	607	280	328	1485	1440	250	1470	280	29	140	512	
100/250	55	125	100	140	610	550	755	280	353	1715	1440	250	1470	280	29	140	559	
100/250	75	125	100	140	730	670	875	280	403	1821	1840	320	1870	350	29	140	1079	
100/250	90	125	100	140	730	670	875	280	403	1821	1840	320	1870	350	29	140	1160	
125/200	55	150	125	140	610	550	755	315	353	1715	1440	250	1470	280	29	140	566	
125/200	75	150	125	140	730	670	875	315	403	1821	1840	320	1870	350	29	140	1088	
125/200	90	150	125	140	730	670	875	315	403	1821	1840	320	1870	350	29	140	1169	
125/200	110	150	125	140	730	670	968	315	438	1994	1840	320	1870	350	29	140	1375	

Maßzeichnung (ohne Ausbaupumpe)

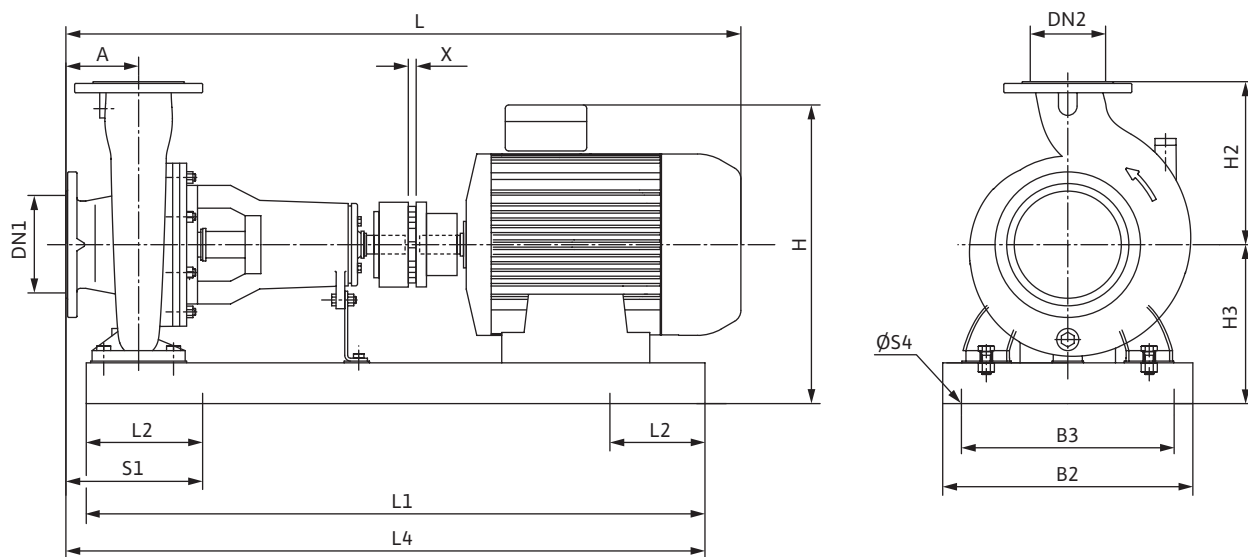

Maße, Gewichte (1450 1/min; ohne Ausbaupumpe)

Wilo-Crono-Norm-NL...	Motor-nenn-leis-tung P ₂ kW	Nennweite		Abmessungen													Ge-wicht netto ca. m kg
		DN1	DN2	A	B2	B3	H	H2	H3	L	L1	L2	L4	S1	ØS4	X	
32/125	0,37	50	32	80	360	320	302	140	195	696	830	145	835	150	19	3	83
32/160	0,37	50	32	80	360	320	322	160	215	696	830	145	835	150	19	3	95
32/160	0,55	50	32	80	360	320	330	160	215	727	830	145	835	150	19	3	88
32/160	0,75	50	32	80	360	320	355	160	215	719	830	145	835	150	19	3	96
32/160B	0,37	50	32	80	360	320	322	160	215	696	830	145	835	150	19	3	95
32/160B	0,55	50	32	80	360	320	330	160	215	727	830	145	835	150	19	3	88
32/160B	0,75	50	32	80	360	320	355	160	215	719	830	145	835	150	19	3	96
32/200	0,55	50	32	80	360	320	358	180	243	727	830	145	835	150	19	3	156
32/200	0,75	50	32	80	360	320	383	180	243	719	830	145	835	150	19	3	98
32/200	1,1	50	32	80	360	320	402	180	243	732	830	145	835	150	19	3	98
32/200	1,5	50	32	80	360	320	402	180	243	747	830	145	835	150	19	3	110
32/200B	0,55	50	32	80	360	320	358	180	243	727	830	145	835	150	19	3	90
32/200B	0,75	50	32	80	360	320	383	180	243	719	830	145	835	150	19	3	98
32/200B	1,1	50	32	80	360	320	402	180	243	732	830	145	835	150	19	3	98
32/200B	1,5	50	32	80	360	320	402	180	243	747	830	145	835	150	19	3	110
32/250	0,75	50	32	100	450	400	423	225	283	739	1030	185	1043	198	24	3	143
32/250	1,1	50	32	100	450	400	442	225	283	752	1030	185	1043	198	24	3	143
32/250	1,5	50	32	100	450	400	442	225	283	767	1030	185	1043	198	24	3	150
32/250	2,2	50	32	100	450	400	452	225	283	839	1030	185	1043	198	24	3	161

Maße, Gewichte (1450 1/min; ohne Ausbaupflung)

Wilo-Crono-Norm-NL...	Motor-nenn-leistung P_2 kW	Nennweite		Abmessungen													Gewicht netto ca. m kg
		DN1	DN2	A	B2	B3	H	H2	H3	L mm	L1	L2	L4	S1	ØS4	X	
40/125	0,37	65	40	80	360	320	302	140	195	696	830	145	835	150	19	3	80
40/125	0,55	65	40	80	360	320	310	140	195	727	830	145	835	150	19	3	82
40/160	0,37	65	40	80	360	320	322	160	215	696	830	145	835	150	19	3	92
40/160	0,55	65	40	80	360	320	330	160	215	727	830	145	835	150	19	3	85
40/160	0,75	65	40	80	360	320	355	160	215	719	830	145	835	150	19	3	94
40/160	1,1	65	40	80	360	320	374	160	215	732	830	145	835	150	19	3	98
40/160	1,5	65	40	80	360	320	374	160	215	747	830	145	835	150	19	3	99
40/200	0,55	65	40	100	390	350	358	180	243	747	930	165	955	190	19	3	103
40/200	0,75	65	40	100	390	350	383	180	243	739	930	165	955	190	19	3	112
40/200	1,1	65	40	100	390	350	402	180	243	752	930	165	955	190	19	3	121
40/200	1,5	65	40	100	390	350	402	180	243	767	930	165	955	190	19	3	122
40/200	2,2	65	40	100	390	350	412	180	243	839	930	165	955	190	19	3	134
40/250	1,1	65	40	100	450	400	442	225	283	752	1030	185	1043	198	24	3	148
40/250	1,5	65	40	100	450	400	442	225	283	767	1030	185	1043	198	24	3	149
40/250	2,2	65	40	100	450	400	452	225	283	839	1030	185	1043	198	24	3	161
40/250	3	65	40	100	450	400	452	225	283	883	1030	185	1043	198	24	3	164
40/315	2,2	65	40	125	490	440	497	250	328	974	1150	205	1188	243	24	3	226
40/315	3	65	40	125	490	440	497	250	328	1018	1150	205	1188	243	24	3	229
40/315	4	65	40	125	490	440	520	250	328	991	1150	205	1188	243	24	3	237
40/315	5,5	65	40	125	490	440	548	250	328	1027	1150	205	1188	243	24	3	261
50/125	0,37	65	50	100	360	320	322	160	215	716	830	145	855	170	19	3	92
50/125	0,55	65	50	100	360	320	330	160	215	747	830	145	855	170	19	3	85
50/125	0,75	65	50	100	360	320	355	160	215	739	830	145	855	170	19	3	94
50/160	0,55	65	50	100	390	350	358	180	243	747	930	165	955	190	19	3	103
50/160	0,75	65	50	100	390	350	383	180	243	739	930	165	955	190	19	3	112
50/160	1,1	65	50	100	390	350	402	180	243	752	930	165	955	190	19	3	121
50/160	1,5	65	50	100	390	350	402	180	243	767	930	165	955	190	19	3	122
50/160	2,2	65	50	100	390	350	412	180	243	839	930	165	955	190	19	3	134
50/200	1,1	65	50	100	390	350	402	200	243	752	930	165	955	190	19	3	126
50/200	1,5	65	50	100	390	350	402	200	243	767	930	165	955	190	19	3	126
50/200	2,2	65	50	100	390	350	412	200	243	839	930	165	955	190	19	3	138
50/200	3	65	50	100	390	350	412	200	243	883	930	165	955	190	19	3	141
50/250	1,5	65	50	100	450	400	442	225	283	767	1030	185	1043	198	24	3	153
50/250	2,2	65	50	100	450	400	452	225	283	839	1030	185	1043	198	24	3	165
50/250	3	65	50	100	450	400	452	225	283	883	1030	185	1043	198	24	3	168
50/250	4	65	50	100	450	400	475	225	283	856	1030	185	1043	198	24	3	172
50/315	4	65	50	125	490	440	520	280	328	991	1150	205	1188	243	24	3	252
50/315	5,5	65	50	125	490	440	548	280	328	1027	1150	205	1188	243	24	3	277
50/315	7,5	65	50	125	490	440	510	280	328	1074	1150	205	1188	243	24	3	264
50/315	9	65	50	125	490	440	548	280	328	1113	1150	205	1188	243	24	3	301
65/125	0,55	80	65	100	390	350	358	180	243	747	930	165	943	178	19	3	100
65/125	0,75	80	65	100	390	350	383	180	243	739	930	165	943	178	19	3	108
65/125	1,1	80	65	100	390	350	402	180	243	752	930	165	943	178	19	3	118
65/160	0,75	80	65	100	390	350	383	200	243	739	930	165	943	178	19	3	115
65/160	1,5	80	65	100	390	350	402	200	243	767	930	165	943	178	19	3	125

Maße, Gewichte (1450 1/min; ohne Ausbaupumpe)																		
Wilo-Crono-Norm-NL...	Motor-nenn-leistung P ₂ kW	Nennweite		Abmessungen														Gewicht netto ca. m kg
		DN1	DN2	A	B2	B3	H	H2	H3	L mm	L1	L2	L4	S1	ØS4	X		
65/160	2,2	80	65	100	390	350	412	200	243	839	930	165	943	178	19	3	137	
65/200	1,1	80	65	100	450	400	442	225	283	752	1030	185	1043	198	24	3	143	
65/200	1,5	80	65	100	450	400	442	225	283	767	1030	185	1043	198	24	3	148	
65/200	2,2	80	65	100	450	400	452	225	283	839	1030	185	1043	198	24	3	160	
65/200	3	80	65	100	450	400	452	225	283	883	1030	185	1043	198	24	3	163	
65/200	4	80	65	100	450	400	475	225	283	856	1030	185	1043	198	24	3	167	
65/250	2,2	80	65	100	490	440	472	250	303	949	1150	205	1145	200	24	3	221	
65/250	3	80	65	100	490	440	472	250	303	993	1150	205	1145	200	24	3	224	
65/250	4	80	65	100	490	440	495	250	303	966	1150	205	1145	200	24	3	231	
65/250	5,5	80	65	100	490	440	523	250	303	1012	1150	205	1145	200	24	3	253	
65/315	5,5	80	65	125	540	490	548	280	328	1027	1290	225	1305	240	24	3	312	
65/315	7,5	80	65	125	540	490	510	280	328	1074	1290	225	1305	240	24	3	299	
65/315	9	80	65	125	540	490	548	280	328	1113	1290	225	1305	240	24	3	336	
65/315	11	80	65	125	540	490	528	280	328	1174	1290	225	1305	240	24	3	334	
65/315	15	80	65	125	540	490	528	280	328	1174	1290	225	1305	240	24	3	351	
80/160	1,1	100	80	125	450	400	442	225	283	777	1030	185	1068	223	24	3	146	
80/160	1,5	100	80	125	450	400	442	225	283	792	1030	185	1068	223	24	3	142	
80/160	2,2	100	80	125	450	400	452	225	283	864	1030	185	1068	223	24	3	157	
80/160	3	100	80	125	450	400	452	225	283	908	1030	185	1068	223	24	3	161	
80/160	4	100	80	125	450	400	475	225	283	881	1030	185	1068	223	24	3	165	
80/200	1,5	100	80	125	490	440	442	250	283	902	1150	205	1188	243	24	3	198	
80/200	2,2	100	80	125	490	440	452	250	283	974	1150	205	1188	243	24	3	209	
80/200	3	100	80	125	490	440	452	250	283	1018	1150	205	1188	243	24	3	212	
80/200	4	100	80	125	490	440	475	250	283	991	1150	205	1188	243	24	3	216	
80/200	5,5	100	80	125	490	440	503	250	283	1027	1150	205	1188	243	24	3	240	
80/250	3	100	80	125	540	490	472	280	303	1018	1290	225	1305	240	24	3	260	
80/250	4	100	80	125	540	490	495	280	303	991	1290	225	1305	240	24	3	267	
80/250	5,5	100	80	125	540	490	523	280	303	1027	1290	225	1305	240	24	3	289	
80/250	7,5	100	80	125	540	490	485	280	303	1074	1290	225	1305	240	24	3	276	
80/315	5,5	100	80	125	540	490	573	315	353	1027	1290	225	1305	240	24	3	317	
80/315	7,5	100	80	125	540	490	535	315	353	1074	1290	225	1305	240	24	3	305	
80/315	9	100	80	125	540	490	573	315	353	1113	1290	225	1305	240	24	3	342	
80/315	11	100	80	125	540	490	553	315	353	1174	1290	225	1305	240	24	3	343	
80/315	15	100	80	125	540	490	553	315	353	1174	1290	225	1305	240	24	3	351	
80/400	11	125	80	125	610	550	583	355	383	1234	1440	250	1455	265	29	3	456	
80/400	15	125	80	125	610	550	583	355	383	1234	1440	250	1455	265	29	3	465	
80/400	18,5	125	80	125	610	550	655	355	383	1307	1440	250	1455	265	29	3	482	
80/400	22	125	80	125	610	550	655	355	383	1307	1440	250	1455	265	29	3	500	
80/400	30	125	80	125	610	550	644	355	383	1323	1440	250	1455	265	29	3	532	
100/160	2,2	125	100	125	490	440	472	280	303	974	1150	205	1170	225	24	3	230	
100/160	3	125	100	125	490	440	472	280	303	1018	1150	205	1170	225	24	3	233	
100/160	4	125	100	125	490	440	495	280	303	991	1150	205	1170	225	24	3	239	
100/160	5,5	125	100	125	490	440	523	280	303	1027	1150	205	1170	225	24	3	277	
100/200	2,2	125	100	125	490	440	472	280	303	974	1150	205	1170	225	24	3	221	
100/200	3	125	100	125	490	440	472	280	303	1018	1150	205	1170	225	24	3	224	

Maße, Gewichte (1450 1/min; ohne Ausbaupumpe)																	
Wilo-Crono-Norm-NL...	Motor-nenn-leistung P_2 kW	Nennweite		Abmessungen													Gewicht netto ca. m kg
		DN1	DN2	A	B2	B3	H	H2	H3	L mm	L1	L2	L4	S1	ØS4	X	
100/200	4	125	100	125	490	440	495	280	303	991	1150	205	1170	225	24	3	231
100/200	5,5	125	100	125	490	440	523	280	303	1027	1150	205	1170	225	24	3	253
100/200	7,5	125	100	125	490	440	485	280	303	1074	1150	205	1170	225	24	3	240
100/250	4	125	100	140	540	490	520	280	328	1006	1290	225	1320	255	24	3	280
100/250	5,5	125	100	140	540	490	548	280	328	1042	1290	225	1320	255	24	3	305
100/250	7,5	125	100	140	540	490	510	280	328	1089	1290	225	1320	255	24	3	292
100/250	9	125	100	140	540	490	548	280	328	1128	1290	225	1320	255	24	3	329
100/250	11	125	100	140	540	490	528	280	328	1189	1290	225	1320	255	24	3	326
100/315	11	125	100	140	540	490	553	315	353	1189	1290	225	1320	255	24	3	352
100/315	15	125	100	140	540	490	553	315	353	1189	1290	225	1320	255	24	3	360
100/315	18,5	125	100	140	540	490	625	315	353	1262	1290	225	1320	255	24	3	378
100/315	22	125	100	140	540	490	625	315	353	1262	1290	225	1320	255	24	3	395
100/400	15	125	100	140	660	600	603	355	403	1249	1640	290	1650	300	29	3	517
100/400	18,5	125	100	140	660	600	675	355	403	1322	1640	290	1650	300	29	3	535
100/400	22	125	100	140	660	600	675	355	403	1322	1640	290	1650	300	29	3	553
100/400	30	125	100	140	660	600	664	355	403	1338	1640	290	1650	300	29	3	584
100/400	37	125	100	140	660	600	682	355	403	1438	1640	290	1650	300	29	3	638
100/400	45	125	100	140	660	600	682	355	403	1438	1640	290	1650	300	29	3	672
125/200	7,5	150	125	140	540	490	535	315	353	1089	1290	225	1320	255	24	3	310
125/200	9	150	125	140	540	490	573	315	353	1128	1290	225	1320	255	24	3	347
125/200	11	150	125	140	540	490	553	315	353	1189	1290	225	1320	255	24	3	348
125/200	15	150	125	140	540	490	553	315	353	1189	1290	225	1320	255	24	3	356
125/250	7,5	150	125	140	540	490	535	355	353	1089	1290	225	1320	255	24	3	312
125/250	9	150	125	140	540	490	573	355	353	1128	1290	225	1320	255	24	3	349
125/250	11	150	125	140	540	490	553	355	353	1189	1290	225	1320	255	24	3	350
125/250	15	150	125	140	540	490	553	355	353	1189	1290	225	1320	255	24	3	359
125/250	18,5	150	125	140	540	490	625	355	353	1262	1290	225	1320	255	24	3	376
125/315	15	150	125	140	660	600	603	355	403	1249	1640	290	1650	300	29	3	495
125/315	18,5	150	125	140	660	600	675	355	403	1322	1640	290	1650	300	29	3	513
125/315	22	150	125	140	660	600	675	355	403	1322	1640	290	1650	300	29	3	531
125/315	30	150	125	140	660	600	664	355	403	1338	1640	290	1650	300	29	3	562
125/315	37	150	125	140	660	600	682	355	403	1438	1640	290	1650	300	29	3	617
125/400	30	150	125	140	660	600	699	400	438	1338	1640	290	1650	300	29	3	606
125/400	37	150	125	140	660	600	717	400	438	1438	1640	290	1650	300	29	3	660
125/400	45	150	125	140	660	600	717	400	438	1438	1640	290	1650	300	29	3	694
125/400	55	150	125	140	660	600	840	400	438	1638	1640	290	1650	300	29	3	721
125/400	75	150	125	140	730	670	910	400	438	1744	1840	320	1850	330	29	3	1166
150/200	7,5	200	150	160	730	670	585	400	403	1109	1840	320	1870	350	29	3	517
150/200	9	200	150	160	730	670	623	400	403	1148	1840	320	1870	350	29	3	555
150/200	11	200	150	160	730	670	603	400	403	1209	1840	320	1870	350	29	3	558
150/200	15	200	150	160	730	670	603	400	403	1209	1840	320	1870	350	29	3	567
150/200	18,5	200	150	160	730	670	675	400	403	1282	1840	320	1870	350	29	3	584
150/250	15	200	150	160	660	600	603	400	403	1209	1640	290	1670	320	29	3	478
150/250	18,5	200	150	160	660	600	675	400	403	1282	1640	290	1670	320	29	3	496
150/250	22	200	150	160	660	600	675	400	403	1282	1640	290	1670	320	29	3	514

Maße, Gewichte (1450 1/min; ohne Ausbaupumpe)																	
Wilo-Crono-Norm-NL...	Motor-nennleistung P_2 kW	Nennweite		Abmessungen													Gewicht netto ca. m kg
		DN1	DN2	A	B2	B3	H	H2	H3	L mm	L1	L2	L4	S1	ØS4	X	
150/250	30	200	150	160	660	600	664	400	403	1298	1640	290	1670	320	29	3	545
150/315	22	200	150	160	730	670	675	400	403	1342	1840	320	1870	350	29	3	639
150/315	30	200	150	160	730	670	664	400	403	1358	1840	320	1870	350	29	3	671
150/315	37	200	150	160	730	670	682	400	403	1458	1840	320	1870	350	29	3	725
150/315	45	200	150	160	730	670	682	400	403	1458	1840	320	1870	350	29	3	759
150/315	55	200	150	160	730	670	805	400	403	1658	1840	320	1870	350	29	3	786
150/400	45	200	150	160	730	670	717	450	438	1458	1840	320	1870	350	29	3	819
150/400	55	200	150	160	730	670	840	450	438	1658	1840	320	1870	350	29	3	845
150/400	75	200	150	160	730	670	910	450	438	1764	1840	320	1870	350	29	3	1197
150/400	90	200	150	160	730	670	910	450	438	1764	1840	320	1870	350	29	3	1268

Maße, Gewichte (2900 1/min; ohne Ausbaupumpe)																	
Wilo-Crono-Norm-NL...	Motor-nennleistung P_2 kW	Nennweite		Abmessungen													Gewicht netto ca. m kg
		DN1	DN2	A	B2	B3	H	H2	H3	L mm	L1	L2	L4	S1	ØS4	X	
32/125	0,55	50	32	80	360	320	302	140	195	696	830	145	835	150	19	3	83
32/125	0,75	50	32	80	360	320	335	140	195	719	830	145	835	150	19	3	90
32/125	1,1	50	32	80	360	320	335	140	195	719	830	145	835	150	19	3	92
32/125	1,5	50	32	80	360	320	327	140	195	747	830	145	835	150	19	3	95
32/125	2,2	50	32	80	360	320	354	140	195	772	830	145	835	150	19	3	97
32/160	1,5	50	32	80	360	320	347	160	215	747	830	145	835	150	19	3	97
32/160	2,2	50	32	80	360	320	374	160	215	772	830	145	835	150	19	3	103
32/160	3	50	32	80	360	320	384	160	215	819	830	145	835	150	19	3	115
32/160	4	50	32	80	360	320	407	160	215	836	830	145	835	150	19	3	121
32/160	5,5	50	32	80	360	320	397	160	215	895	830	145	835	150	19	3	142
32/160B	1,5	50	32	80	360	320	347	160	215	747	830	145	835	150	19	3	97
32/160B	2,2	50	32	80	360	320	374	160	215	772	830	145	835	150	19	3	103
32/160B	3	50	32	80	360	320	384	160	215	819	830	145	835	150	19	3	115
32/160B	4	50	32	80	360	320	407	160	215	836	830	145	835	150	19	3	121
32/160B	5,5	50	32	80	360	320	397	160	215	895	830	145	835	150	19	3	142
32/200	2,2	50	32	80	360	320	402	180	243	772	830	145	835	150	19	3	116
32/200	3	50	32	80	360	320	412	180	243	819	830	145	835	150	19	3	121
32/200	4	50	32	80	360	320	435	180	243	836	830	145	835	150	19	3	126
32/200	5,5	50	32	80	360	320	425	180	243	895	830	145	835	150	19	3	146
32/200	7,5	50	32	80	360	320	425	180	243	918	830	145	835	150	19	3	139
32/200	9	50	32	80	360	320	463	180	243	933	830	145	835	150	19	3	161
32/200	11	50	32	80	450	400	463	180	263	1019	1030	185	1035	190	24	3	189
32/200B	2,2	50	32	80	360	320	402	180	243	772	830	145	835	150	19	3	116
32/200B	3	50	32	80	360	320	412	180	243	819	830	145	835	150	19	3	121
32/200B	4	50	32	80	360	320	435	180	243	836	830	145	835	150	19	3	126
32/200B	5,5	50	32	80	360	320	425	180	243	895	830	145	835	150	19	3	146
32/200B	7,5	50	32	80	360	320	425	180	243	918	830	145	835	150	19	3	139
32/200B	9	50	32	80	360	320	463	180	243	933	830	145	835	150	19	3	186

Maße, Gewichte (2900 1/min; ohne Ausbaupumpe)																		
Wilo-Crono-Norm-NL...	Motor-nennleistung	Nennweite		Abmessungen														Gewicht netto ca.
		DN1	DN2	A	B2	B3	H	H2	H3	L mm	L1	L2	L4	S1	ØS4	X	m kg	
32/200B	11	50	32	80	450	400	463	180	263	1019	1030	185	1035	190	24	3	189	
32/250	7,5	50	32	100	450	400	465	225	283	938	1030	185	1043	198	24	3	189	
32/250	9	50	32	100	450	400	503	225	283	953	1030	185	1043	198	24	3	198	
32/250	11	50	32	100	450	400	483	225	283	1039	1030	185	1043	198	24	3	206	
32/250	15	50	32	100	450	400	483	225	283	1039	1030	185	1043	198	24	3	215	
40/125	1,1	65	40	80	360	320	335	140	195	719	830	145	835	150	19	3	89	
40/125	1,5	65	40	80	360	320	327	140	195	747	830	145	835	150	19	3	91	
40/125	2,2	65	40	80	360	320	354	140	195	772	830	145	835	150	19	3	97	
40/125	3	65	40	80	360	320	364	140	195	819	830	145	835	150	19	3	109	
40/160	2,2	65	40	80	360	320	374	160	215	772	830	145	835	150	19	3	97	
40/160	3	65	40	80	360	320	384	160	215	819	830	145	835	150	19	3	111	
40/160	4	65	40	80	360	320	407	160	215	836	830	145	835	150	19	3	118	
40/160	5,5	65	40	80	360	320	397	160	215	895	830	145	835	150	19	3	139	
40/160	7,5	65	40	80	360	320	397	160	215	918	830	145	835	150	19	3	132	
40/160	9	65	40	80	360	320	435	160	215	933	830	145	835	150	19	3	154	
40/200	5,5	65	40	100	390	350	425	180	243	915	930	165	955	190	19	3	158	
40/200	7,5	65	40	100	390	350	425	180	243	938	930	165	955	190	19	3	150	
40/200	9	65	40	100	390	350	463	180	243	953	930	165	955	190	19	3	174	
40/200	11	65	40	100	450	400	463	180	263	1039	1030	185	1055	210	24	3	191	
40/200	15	65	40	100	450	400	463	180	263	1039	1030	185	1055	210	24	3	201	
40/200	18,5	65	40	100	450	400	463	180	263	1039	1030	185	1055	210	24	3	202	
40/250	7,5	65	40	100	450	400	465	225	283	938	1030	185	1043	198	24	3	174	
40/250	9	65	40	100	450	400	503	225	283	953	1030	185	1043	198	24	3	198	
40/250	11	65	40	100	450	400	483	225	283	1039	1030	185	1043	198	24	3	206	
40/250	15	65	40	100	450	400	483	225	283	1039	1030	185	1043	198	24	3	215	
40/250	18,5	65	40	100	450	400	483	225	283	1039	1030	185	1043	198	24	3	216	
40/315	15	65	40	125	490	440	528	250	328	1174	1150	205	1188	243	24	3	285	
40/315	18,5	65	40	125	490	440	528	250	328	1174	1150	205	1188	243	24	3	287	
40/315	22	65	40	125	490	440	600	250	328	1247	1150	205	1188	243	24	3	302	
40/315	30	65	40	125	540	490	589	250	328	1263	1290	225	1323	258	24	3	367	
40/315	37	65	40	125	540	490	589	250	328	1263	1290	225	1323	258	24	3	400	
50/125	1,5	65	50	100	360	320	347	160	215	747	830	145	855	170	19	3	94	
50/125	2,2	65	50	100	360	320	374	160	215	792	830	145	855	170	19	3	97	
50/125	3	65	50	100	360	320	384	160	215	839	830	145	855	170	19	3	111	
50/125	4	65	50	100	360	320	407	160	215	856	830	145	855	170	19	3	118	
50/125	5,5	65	50	100	360	320	397	160	215	915	830	145	855	170	19	3	139	
50/160	3	65	50	100	390	350	412	180	243	839	930	165	955	190	19	3	134	
50/160	4	65	50	100	390	350	435	180	243	856	930	165	955	190	19	3	139	
50/160	5,5	65	50	100	390	350	425	180	243	915	930	165	955	190	19	3	158	
50/160	7,5	65	50	100	390	350	425	180	243	938	930	165	955	190	19	3	150	
50/160	9	65	50	100	390	350	463	180	243	953	930	165	955	190	19	3	174	
50/160	11	65	50	100	450	400	463	180	263	1039	1030	185	1055	210	24	3	191	
50/160	15	65	50	100	450	400	463	180	263	1039	1030	185	1055	210	24	3	201	
50/200	7,5	65	50	100	390	350	425	200	243	938	930	165	955	190	19	3	154	
50/200	9	65	50	100	390	350	463	200	243	953	930	165	955	190	19	3	178	

Maße, Gewichte (2900 1/min; ohne Ausbaupumpe)																		
Wilo-Crono-Norm-NL...	Motor-nennleistung P_2 kW	Nennweite		Abmessungen														Gewicht netto ca. m kg
		DN1	DN2	A	B2	B3	H	H2	H3	L mm	L1	L2	L4	S1	ØS4	X		
50/200	11	65	50	100	450	400	463	200	263	1039	1030	185	1055	210	24	3	195	
50/200	15	65	50	100	450	400	463	200	263	1039	1030	185	1055	210	24	3	205	
50/200	18,5	65	50	100	450	400	463	200	263	1039	1030	185	1055	210	24	3	206	
50/200	22	65	50	100	450	400	555	200	283	1156	1030	185	1055	210	24	3	229	
50/250	11	65	50	100	450	400	483	225	283	1039	1030	185	1043	198	24	3	210	
50/250	15	65	50	100	450	400	483	225	283	1039	1030	185	1043	198	24	3	219	
50/250	18,5	65	50	100	450	400	483	225	283	1039	1030	185	1043	198	24	3	220	
50/250	22	65	50	100	450	400	555	225	283	1112	1030	185	1043	198	24	3	235	
50/250	30	65	50	100	540	490	564	225	303	1128	1290	225	1298	233	24	3	343	
50/315	15	65	50	125	490	440	528	280	328	1174	1150	205	1188	243	24	3	301	
50/315	18,5	65	50	125	490	440	528	280	328	1174	1150	205	1188	243	24	3	302	
50/315	22	65	50	125	490	440	600	280	328	1247	1150	205	1188	243	24	3	317	
50/315	30	65	50	125	540	490	589	280	328	1263	1290	225	1323	258	24	3	383	
50/315	37	65	50	125	540	490	589	280	328	1263	1290	225	1323	258	24	3	416	
50/315	45	65	50	125	540	490	607	280	328	1333	1290	225	1323	258	24	3	482	
50/315	55	65	50	125	610	550	755	280	353	1563	1440	250	1473	283	29	3	555	
50/315	75	65	50	125	730	670	875	280	403	1669	1840	320	1873	353	29	3	1073	
65/125	3	80	65	100	390	350	412	180	243	839	930	165	943	178	19	3	131	
65/125	4	80	65	100	390	350	435	180	243	856	930	165	943	178	19	3	135	
65/125	5,5	80	65	100	390	350	425	180	243	915	930	165	943	178	19	3	155	
65/125	7,5	80	65	100	390	350	425	180	243	938	930	165	943	178	19	3	147	
65/125	9	80	65	100	390	350	473	180	243	953	930	165	943	178	19	3	171	
65/160	5,5	80	65	100	390	350	425	200	243	915	930	165	943	178	19	3	162	
65/160	7,5	80	65	100	390	350	425	200	243	938	930	165	943	178	19	3	153	
65/160	9	80	65	100	390	350	473	200	243	953	930	165	943	178	19	3	177	
65/160	11	80	65	100	450	400	463	200	263	1039	1030	185	1043	198	24	3	194	
65/160	15	80	65	100	450	400	463	200	263	1039	1030	185	1043	198	24	3	204	
65/160	18,5	80	65	100	450	400	463	200	263	1039	1030	185	1043	198	24	3	205	
65/200	9	80	65	100	450	400	503	225	283	953	1030	185	1043	198	24	3	197	
65/200	11	80	65	100	450	400	483	225	283	1039	1030	185	1043	198	24	3	205	
65/200	15	80	65	100	450	400	483	225	283	1039	1030	185	1043	198	24	3	214	
65/200	18,5	80	65	100	450	400	483	225	283	1039	1030	185	1043	198	24	3	215	
65/200	22	80	65	100	450	400	555	225	283	1112	1030	185	1043	198	24	3	230	
65/200	30	80	65	100	540	490	564	225	303	1128	1290	225	1298	233	24	3	338	
65/250	18,5	80	65	100	490	440	503	250	303	1149	1150	205	1145	200	24	3	279	
65/250	22	80	65	100	490	440	575	250	303	1222	1150	205	1145	200	24	3	294	
65/250	30	80	65	100	540	490	564	250	303	1238	1290	225	1280	215	24	3	359	
65/250	37	80	65	100	540	490	564	250	303	1238	1290	225	1280	215	24	3	392	
65/250	45	80	65	100	540	490	607	250	328	1308	1290	225	1280	215	24	3	471	
80/160	7,5	100	80	125	450	400	465	225	283	963	1030	185	1068	223	24	3	171	
80/160	9	100	80	125	450	400	503	225	283	978	1030	185	1068	223	24	3	195	
80/160	11	100	80	125	450	400	483	225	283	1064	1030	185	1068	223	24	3	203	
80/160	15	100	80	125	450	400	483	225	283	1064	1030	185	1068	223	24	3	212	
80/160	18,5	100	80	125	450	400	483	225	283	1064	1030	185	1068	223	24	3	213	
80/160	22	100	80	125	450	400	555	225	283	1137	1030	185	1068	223	24	3	228	

Maße, Gewichte (2900 1/min; ohne Ausbaupumpe)

Wilo-Crono-Norm-NL...	Motor-nennleistung	Nennweite		Abmessungen													Gewicht netto ca.
		DN1	DN2	A	B2	B3	H	H2	H3	L mm	L1	L2	L4	S1	ØS4	X	
80/160	30	100	80	125	540	490	564	225	303	1153	1290	225	1323	258	24	3	336
80/200	15	100	80	125	490	440	483	250	283	1174	1150	205	1188	243	24	3	263
80/200	18,5	100	80	125	490	440	483	250	283	1174	1150	205	1188	243	24	3	265
80/200	22	100	80	125	490	440	555	250	283	1247	1150	205	1188	243	24	3	280
80/200	30	100	80	125	540	490	564	250	303	1263	1290	225	1323	258	24	3	353
80/200	37	100	80	125	540	490	564	250	303	1263	1290	225	1323	258	24	3	386
80/200	45	100	80	125	540	490	607	250	328	1333	1290	225	1323	258	24	3	464
80/250	22	100	80	125	540	490	575	280	303	1247	1290	225	1305	240	24	3	330
80/250	30	100	80	125	540	490	564	280	303	1263	1290	225	1305	240	24	3	364
80/250	37	100	80	125	540	490	564	280	303	1263	1290	225	1305	240	24	3	397
80/250	45	100	80	125	540	490	607	280	328	1333	1290	225	1305	240	24	3	476
80/250	55	100	80	125	610	550	755	280	353	1563	1440	250	1455	265	29	3	552
100/160	18,5	125	100	125	490	440	503	280	303	1174	1150	205	1170	225	24	3	287
100/160	22	125	100	125	490	440	575	280	303	1247	1150	205	1170	225	24	3	302
100/160	30	125	100	125	540	490	564	280	303	1263	1290	225	1305	240	24	3	367
100/160	37	125	100	125	540	490	564	280	303	1263	1290	225	1305	240	24	3	400
100/200	18,5	125	100	125	490	440	503	280	303	1174	1150	205	1170	225	24	3	279
100/200	22	125	100	125	490	440	575	280	303	1247	1150	205	1170	225	24	3	294
100/200	30	125	100	125	540	490	564	280	303	1263	1290	225	1305	240	24	3	359
100/200	37	125	100	125	540	490	564	280	303	1263	1290	225	1305	240	24	3	392
100/200	45	125	100	125	540	490	607	280	328	1333	1290	225	1305	240	24	3	471
100/250	30	125	100	140	540	490	589	280	328	1278	1290	225	1320	255	24	3	380
100/250	37	125	100	140	540	490	589	280	328	1278	1290	225	1320	255	24	3	412
100/250	45	125	100	140	540	490	607	280	328	1348	1290	225	1320	255	24	3	479
100/250	55	125	100	140	610	550	755	280	353	1578	1440	250	1470	280	29	3	554
100/250	75	125	100	140	730	670	875	280	403	1684	1840	320	1870	350	29	3	1073
100/250	90	125	100	140	730	670	875	280	403	1684	1840	320	1870	350	29	3	1154
125/200	55	150	125	140	610	550	755	315	353	1578	1440	250	1470	280	29	3	561
125/200	75	150	125	140	730	670	875	315	403	1684	1840	320	1870	350	29	3	1082
125/200	90	150	125	140	730	670	875	315	403	1684	1840	320	1870	350	29	3	1163
125/200	110	150	125	140	730	670	968	315	438	1857	1840	320	1870	350	29	3	1370

Maßzeichnung

Flansch

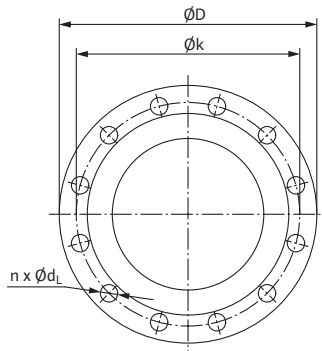

Flanschmaße (Saugseite)

Wilo-CronoNorm-NL...	Nennweite DN1	Flanschmaße Pumpe		
		$\varnothing D$	$\varnothing k$	$n \times d_L$ St. x mm
32...	50	165	125	4 x 19
40...	65	185	145	4 x 19
50...	65	185	145	4 x 19
65...	80	200	160	8 x 19
80...	100	220	180	8 x 19
100...	125	250	210	8 x 19
125...	150	285	240	8 x 23
150...	200	340	295	12 x 23

Flanschmaße (Druckseite)

Wilo-CronoNorm-NL...	Nennweite DN2	Flanschmaße Pumpe		
		$\varnothing D$	$\varnothing k$	$n \times d_L$ St. x mm
32...	32	140	100	4 x 19
40...	40	150	110	4 x 19
50...	50	165	125	4 x 19
65...	65	185	145	4 x 19
80...	80	200	160	8 x 19
100...	100	220	180	8 x 19
125...	125	250	210	8 x 19
150...	150	285	240	8 x 23